



# User Manual

## Mobile Wi-Fi Hotspot 21 Mbps

---

# Preface

D-Link reserves the right to revise this publication and to make changes in the content hereof without obligation to notify any person or organization of such revisions or changes.

## Manual Revisions

Revision	Date	Description
1.0	July 09, 2014	• Initial release
2.0	July 11, 2014	• Change model description
2.10	August 10, 2015	• Change Battery
2.20	December 24, 2015	• Added Windows 10 wireless setup guide
3.00	June 8, 2016	• Minor updates

## Trademarks

D-Link and the D-Link logo are trademarks or registered trademarks of D-Link Corporation or its subsidiaries in the United States or other countries. All other company or product names mentioned herein are trademarks or registered trademarks of their respective companies.

Copyright © 2016 by D-Link Corporation, Inc.

All rights reserved. This publication may not be reproduced, in whole or in part, without prior expressed written permission from D-Link Corporation, Inc.

# Table of Contents

Manual Revisions.....	i	Wizard.....	15
Trademarks .....	i	Internet.....	17
<b>Product Overview.....</b>	<b>1</b>	Connection .....	17
Package Contents.....	1	2G/3G Modem .....	19
System Requirements.....	1	SIM .....	20
Introduction .....	2	PLMN.....	21
Hardware Overview.....	3	Network .....	22
Front Side and Battery Cover.....	3	Wi-Fi.....	22
OLED Display.....	4	DHCP .....	23
		NAT.....	25
<b>Installation .....</b>	<b>6</b>	SMS.....	27
Connect to Your Network .....	6	New Message .....	27
Insert a microSD Card .....	6	Local .....	27
Wireless Installation Considerations.....	7	Wi-Fi.....	28
		Basic.....	28
<b>Configuration.....</b>	<b>8</b>	Wireless Security .....	30
Initial Connection to the Router .....	8	Wired Equivalent Privacy (WEP) .....	30
Connect via USB.....	8	Wi-Fi Protected Access (WPA).....	31
Driver Installation .....	8	Wi-Fi Protected Setup (WPS) .....	32
Connect via Wi-Fi .....	9	MAC Filter .....	33
Web-Based Configuration .....	11	Station Lists.....	34
Configuration Utility.....	11	Security .....	35
Home .....	12	Firewall .....	35
Navigation .....	12	IP Filter .....	35
Device Status.....	13	IPv6 Filter .....	36
Home.....	14	MAC Filter .....	37

DDOS.....	38	<b>Technical Specifications .....</b>	<b>72</b>
URL Filter.....	39	<b>Regulatory Information .....</b>	<b>73</b>
Application .....	40		
About .....	40		
Configuration .....	41		
Firmware Upgrade.....	42		
Standby Mode .....	43		
Password.....	44		
Date and Time .....	45		
Language.....	47		
System Log.....	48		
<b>Connecting to a Wireless Network .....</b>	<b>49</b>		
Using Windows 10 .....	49		
Using Windows 8.1/8.0 .....	51		
Using Windows 7 .....	53		
Configuring Wireless Security .....	55		
Using Windows Vista™ .....	58		
Configuring Wireless Security .....	59		
Using Windows® XP .....	61		
Configure WEP .....	62		
Configure WPA-PSK.....	64		
Using Mac OS .....	66		
<b>Troubleshooting .....</b>	<b>68</b>		
<b>Networking Basics .....</b>	<b>70</b>		
Check your IP address.....	70		
Assign a Static IP address.....	71		

# Product Overview

## Package Contents



D-Link DWR-730 Mobile Wi-Fi Hotspot 21 Mbps



Battery



USB Cable

If any of the above items are missing from your package, please contact your reseller.

## System Requirements

- A compatible (U)SIM card with mobile data service<sup>1</sup>
- A computer with Windows®, Macintosh®, or Linux-based operating system
- Internet Explorer 7, Firefox 12.0, Chrome 20.0, or Safari 5.0

<sup>1</sup> Subject to services and service terms available from your carrier.

# Introduction

The D-Link DWR-730 Mobile Wi-Fi Hotspot 21 Mbps lets you share a fast mobile Internet connection with multiple PCs and mobile devices wherever you go. It offers 3G HSPA+ compatibility for fast downlink and uplink data rates, so you get mobile high-speed upload and download speeds. Set up a personal mobile network anywhere, anytime, allowing you and those around you to access the Internet and share files.

## High-Speed Mobile Internet with 3G Connectivity

The DWR-730 Mobile Wi-Fi Hotspot 21 Mbps gives you high-speed access to the Internet. Using HSPA+ technology, you can achieve download speeds of up to 21.6 Mbps and upload speeds of up to 5.76 Mbps<sup>1</sup>. The built-in 3G antenna provides a reliable connection to your 3G service provider and a separate Wi-Fi antenna gives extended coverage to the computers and mobile devices connected to the DWR-730.

## Mobile Internet for All of Your Devices

The Mobile Wi-Fi Hotspot 21 Mbps lets you share your fast mobile connection over Wi-Fi from a device small enough to fit in your pocket. With the DWR-730, you can get online with your laptop, smartphone, tablet, or any other wireless device using a single 3G mobile connection. The DWR-730 provides high-speed Wireless N coverage to give high-speed wireless access to everybody – whether you are with colleagues on a business trip or travelling with friends and family.

## Built-in Software for Instant Access Anywhere

The DWR-730 is truly plug-and-play, with drivers built right into the router so you can connect without the need to install anything. Open a browser, connect the router, and you can set up your network right from a web interface. Once the device is set up, simply power it on to start up your portable mobile network.

## Designed for True Portability

The DWR-730 Mobile Wi-Fi Hotspot 21 Mbps is small and slim enough to carry around in your purse, bag, or pocket. It features a microSD card slot for optional removable storage (up to 32 GB), allowing you to always have your files and contacts on hand. The built-in 2000 mAh rechargeable Li-Ion battery can provide up to six hours of mobile usage, meaning that you can share your mobile Internet connection in the car, in the park, or anywhere, and work or play longer without needing to recharge.

<sup>1</sup> All references to speed are for comparison purposes only. Actual speeds will vary depending on a range of factors including mobile network coverage, signal strength, network activity, and environmental conditions.

# Hardware Overview

## Front Side and Battery Cover

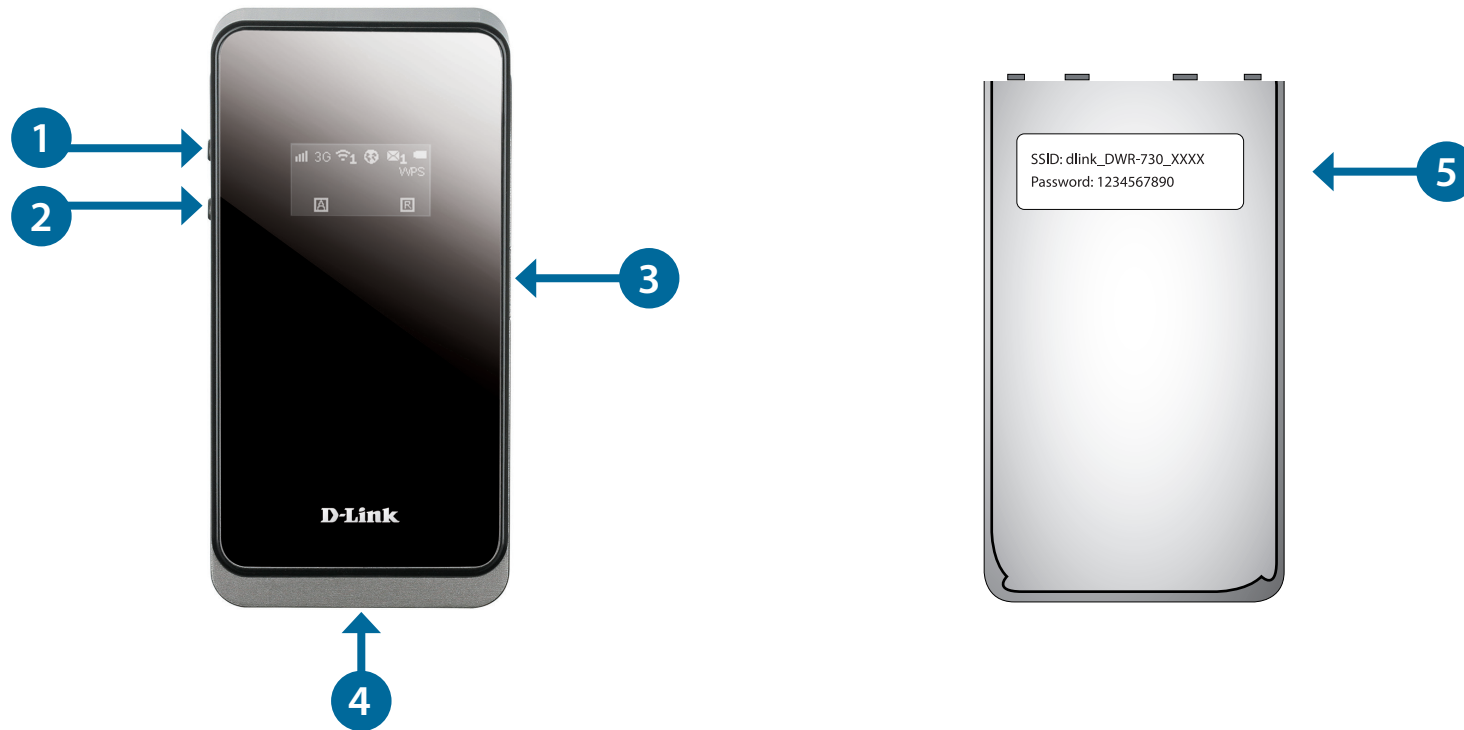

1	<b>Power Button</b>	Press and hold this button for 6 seconds to power on/off the device.
2	<b>WPS Button</b>	Press this button to add new wireless devices quickly and easily using Wi-Fi Protected Setup (WPS). Press and hold for more than 5 seconds to turn the wireless function on/off.
3	<b>microSD Card Slot</b>	Insert a microSD Card (up to 32GB) to access and share files and media wherever you go.
4	<b>micro USB Connector</b>	Use the included cable to connect to a powered USB port to charge the device or to access the configuration utility.
5	<b>Default Network Name and Password</b>	This label displays the DWR-730's default network name (SSID) and network security key (Wi-Fi password).

# Hardware Overview

## OLED Display

This OLED display shows the current status of the DWR-730's functions including mobile network, Wi-Fi, security, Internet status, signal strength, and battery level. Please refer to the table below for the specific indications which are shown on the display.

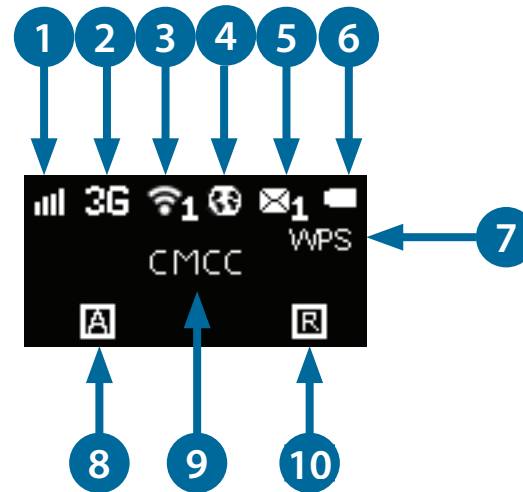

Number	Function	Icon	Indication
1	Network Strength	0-5 Bars	Indicates the strength of the current mobile network connection.
2	Network Type	H+	Currently connected to DC-HSPA or HSPA+ mobile network.
		H	Currently connected to HSPA mobile network.
		3G	Currently connected to WCDMA mobile network.
		2G	Currently connected to GPRS/EDGE network.
		No SIM	No SIM card detected in device



3	Wi-Fi & Clients	Number	Indicates the number of clients currently connected to the device by Wi-Fi.
4	Internet Connection Status	Internet	If this icon is displayed, there is a connection to the Internet.
5	SMS	Number	There are unread SMS messages in the inbox.
6	Battery Status	Empty-Full	Displays the current battery level. If charging, an animation will indicate charging status and current battery level.
7	Wi-Fi Protected Setup	WPS	The device is ready for WPS association with wireless clients.
8	Connection Method	A	The device is set to connect to the mobile network automatically.
		M	The device is set to connect to the mobile network manually.
		D = On Demand	The device will connect to the preferred mobile network when Internet access is required.
9	Operator	Name	The name of the mobile network operator to which device is currently connected.
10	Roaming	R	The device is currently roaming on a network other than the home network.

# Installation

This section will guide you through the installation process.

## Connect to Your Network

1. Ensure that your DWR-730 Mobile Wi-Fi Hotspot 21 Mbps is powered off.
2. Remove the back cover and take out the battery. Slide your (U)SIM card into the slot provided, ensuring that the alignment is the same as indicated by the logo next to the slot. The gold contacts on the card should be facing downwards.

**Caution:** Always unplug and turn off the router before installing or removing the SIM card.  
Never insert or remove the SIM card while the router is in use.

3. Press and hold the power button on the side of the router.
  - a. "D-Link" will be displayed on the screen as the router performs its initialization processes.
  - b. After a few moments, the OLED display will show the current status of the router's various functions. For more details on the OLED display, please refer to "OLED Display" on page 4.

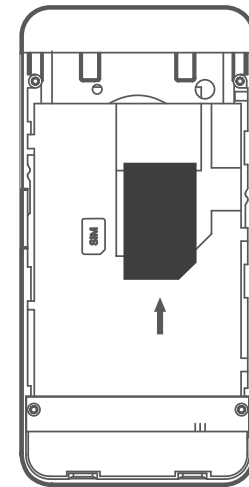

## Insert a microSD Card

1. Ensure that your DWR-730 Mobile Wi-Fi Hotspot 21 Mbps is powered off.
2. Open the cover of the microSD slot on the side of the router.
3. Insert the microSD card into the slot and push it in until it locks into place.

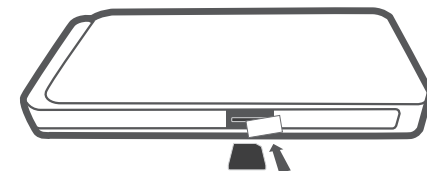

# Wireless Installation Considerations

The DWR-730 can be accessed using a wireless connection from anywhere within the operating range of its wireless network. Keep in mind that the quantity, thickness, and location of walls, ceilings, or other objects that the wireless signals must pass through may adversely affect wireless signals. Ranges vary depending on the types of materials and background RF (radio frequency) noise in your home or office. The key to maximizing the wireless range is to follow these basic guidelines:

1. Minimize the number of walls and ceilings between the router and other network devices. Each wall or ceiling can reduce your adapter's range anywhere from 3 to 90 feet (1 to 30 meters).
2. Be aware of the direct line between network devices. A wall that is 1.5 feet thick (0.5 meters) appears to be almost 3 feet (1 meter) thick at a 45-degree angle. At a 2-degree angle it appears over 42 feet (13 meters) thick. Position devices so that the signal will travel straight through a wall or ceiling (instead of at an angle) for better reception.
3. Try to position access points, wireless routers, and computers so that the signal passes through open doorways and drywall. Materials such as glass, metal, brick, insulation, concrete, and water can affect wireless performance. Large objects such as fish tanks, mirrors, file cabinets, metal doors, and aluminum studs may also have a negative effect on range.
4. If you are using a 2.4 GHz cordless phone, make sure that the 2.4 GHz phone base is as far away from your wireless device as possible. The base transmits a signal even if the phone is not in use. In some cases, cordless phones, X-10 wireless devices, and electronic equipment such as ceiling fans, fluorescent lights, and home security systems may dramatically degrade wireless connectivity.

# Configuration

This section will show you how to configure your new D-Link mobile router using the configuration utility that can be accessed through a web-based user interface.

## Initial Connection to the Router

When configuring the router for the first time, you will need to establish a direct connection with the router in order to access the web-based configuration utility. This can be done using the included USB cable, or by connecting wirelessly to the DWR-730. Once you have configured your router, you will be able to connect using the Wi-Fi settings that you have specified in the configuration process. Ensure that the router is powered on and has sufficient battery power before commencing the setup process.

### Connect via USB

To connect to the router via USB, plug the provided micro USB cable into the micro USB port on the bottom of the router and plug the other end into an available USB port on your computer.

### Driver Installation

When you plug the DWR-730 into your computer, any necessary drivers will immediately install (with your permission).

**Note:** These drivers are Windows-only. Mac and Linux users will still be able to configure the DWR-730 by connecting wirelessly and using the web configuration utility described in “Configuration Utility” on page 11.

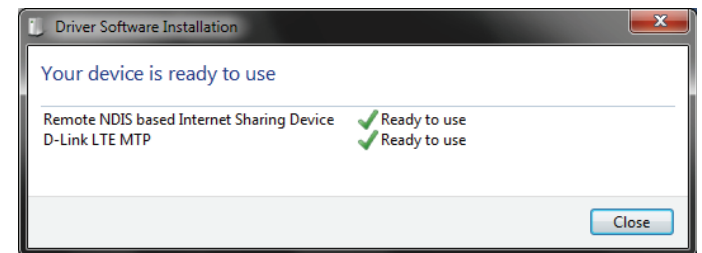

## Connect via Wi-Fi

**Note:** The following example uses Windows 7's built-in wireless connection utility. If you are using a different operating system or a third party connection utility, the process may be different. Please refer to "Connecting to a Wireless Network" on page 49 for further information on how to connect to a wireless network.

To connect to the router using Wi-Fi, open your operating system's wireless networking utility and scan for available networks to connect to. By default, the network name (SSID) and network security key (Wi-Fi password) are printed on a label on the underside of the DWR-730's battery cover. The DWR-730's SSID will be in the format **dlink\_DWR-730xxxx**, where "xxxx" represents the last four characters (or digits) of the router's MAC address.



Once you have located this network with your wireless utility, connect to the network using your wireless networking utility.

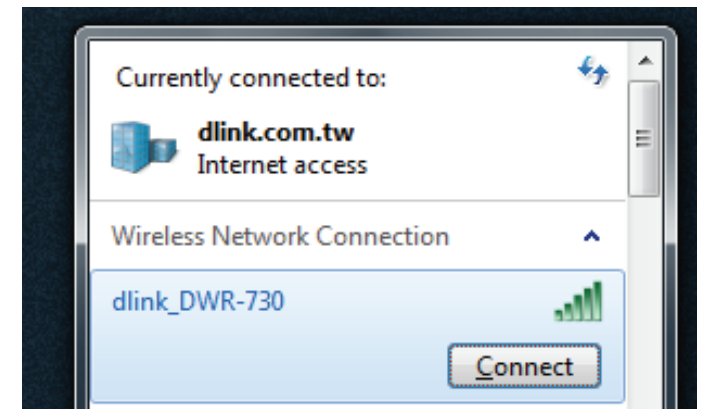

You will then be prompted to enter the network security key for your router. The unique security key for your router will be displayed on a sticker on the underside of router's battery cover. Enter the security key in the box provided and click **OK**. Your wireless connection utility should confirm that the connection is successful, and you can move to the next step to continue the configuration process.

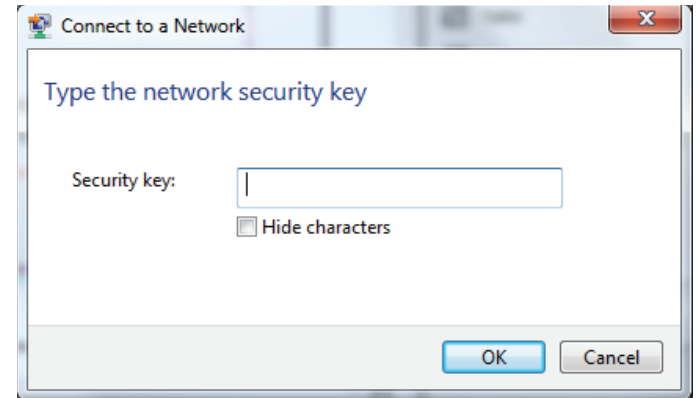

# Web-Based Configuration

To access the configuration utility, open a web browser (such as Internet Explorer) and enter the IP address of the router, which is **192.168.0.1** by default.

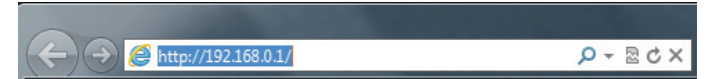

## Configuration Utility

Once you have reached the configuration utility through the installed software or your web browser, you will need to log in. Enter **admin** as the username. By default, the password is blank. You can also select your language from the drop-down menu.

Click **Login** to continue.

A screenshot of the D-Link login page. The page has a light blue background. On the left side, there is a "Login" section with three input fields: "Account", "Password", and "Language". The "Language" field is a drop-down menu currently set to "English". Below these fields is a "Login" button. On the right side of the page, the "D-Link" logo is displayed in a large, bold, black font.

# Home Navigation

Throughout the interface you will find a menu bar at the top of the page which includes tabs for easy navigation, and a summary bar in the upper right corner with a quick view of essential information.



**Home:** The **Home** tab will return you the home page, where a summary of the system information is shown.

**Wizard:** Click on this tab to start the setup wizard, which will guide you through the basic setup process.

**Internet:** The **Internet** tab gives you Internet setup and settings options.

**Network:** The **Network** tab allows you to configure the network settings for your Local Area Network (LAN).

**SMS:** From the **SMS** tab you can view and send SMS messages via your mobile network.

**Wi-Fi:** The **Wi-Fi** tab allows you to configure your Wi-Fi network, as well as add new devices using WPS.

**Security:** The **Security** tab allows you to configure firewall and security settings to protect your network from WAN-side intrusions.

**Application:** From this tab, you can manage the administrative configuration of your router, such as time and date, firmware, language, and remote management.



## Device Status

A summary of the device's current status will be displayed on the information panel at the top of the right-hand side of the navigation bar. The following is a description of the indications, from left to right.

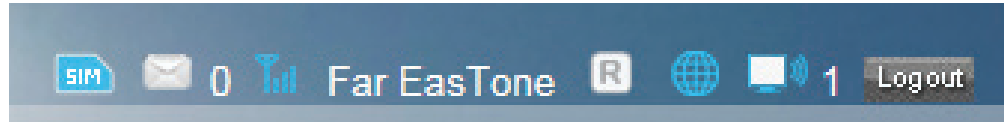

**SIM:** This icon shows whether or not a compatible (U)SIM card has been inserted into the device.

**SMS:** The number to the right of this icon indicates the number of unread messages in the SMS inbox.

**Signal Strength:** Indicates the current strength of the mobile network signal being received.

**Operator Name:** The name of the mobile network operator to which the device is currently connected.

**Roaming:** Indicates that the device is connected to a network other than your service provider's home network.

**Internet:** Indicates that there is an Internet connection present.

**Wi-Fi Network:** Indicates that the router's Wi-Fi network is currently active. The number to the right of this icon indicates the number of wireless clients currently connected to the router's Wi-Fi network.

**Log out:** Click this button to log out of the configuration interface.

# Home

The **Home** page acts as a dashboard to quickly display your configuration settings and provide a summary of the current status of your network.

**System Resources:** This area displays the percentage of the router's memory and CPU currently being used by the system.

**LAN:** This area displays a summary of the current settings for the router's LAN.

**2G/3G Modem:** This area shows the current status of your 2G or 3G mobile network connection.

**WAN:** This area displays a summary of the router's current WAN settings. These details will reflect the mobile network connection which is being received from the service provider.

**Traffic Statistics:** This area shows the amount of data which has been sent (TX) and received (RX) over the mobile network. This information may not reflect the amount recorded by your mobile service provider.

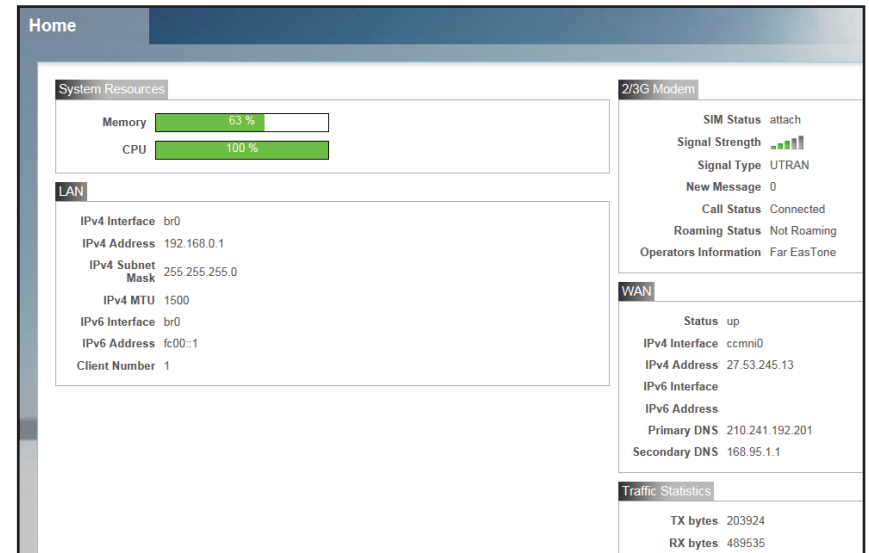

# Wizard

The **Wizard** page will guide you through the steps required to configure the basic settings of your router such as the IP address, network name (SSID), and password. Click on the **Wizard** button on the navigation bar to commence the wizard.

## LAN Configuration

**IP Address:** If you wish to change the router's IP address, enter the new address here. If you change the IP address, you will need to enter the new address in your Internet browser's address bar in order to access the web-based configuration utility.

If you wish to change the router's subnet mask, enter it here.

### IP Subnet Mask:

Click **Next** to continue.

## 2/3G Configuration

If you wish to change the 2G or 3G service provider or connection type, click on a profile in the list to highlight it, and click **Set** to set that profile as the default.

Click **Next** to continue, or **Back** to return to the previous step.

Please consult with service provider for these settings. If not sure, leave them with default value.

Type	Profile				
2/3G Data Connection	PID-7	<input type="button" value="Set"/>			

Profile	Type	Name	APN	User	Password
PID-7	System	(Far EastTone)	internet		
PID-8	System	(Far EastTone) (Fetnet01)	fetnet01		

Total Num : 2

## Wi-Fi Configuration

**Password Setting:** Choose a password for your wireless security. Clients will need this password in order to access your network wirelessly. If you are currently connected to the router using Wi-Fi, you will need to reconnect to the router using your new password once the wizard has been completed.

**SSID:** If you wish to change your wireless network name (SSID), enter a new name in the field provided. If you change the SSID, you will need to reconnect to the router using the new SSID before you can access your network or the configuration utility.

Click **Done** to complete the wizard, or click **Back** to return to the previous page.

After you have clicked **Done**, a confirmation window will appear. Click **OK** to save the configuration.



The screenshot shows the 'WiFi Configuration' wizard at Step 3, 'WiFi Settings'. At the top, there are three tabs: 'Step 1 LAN Settings', 'Step 2 WAN Settings', and 'Step 3 WiFi Settings', with the third tab highlighted in orange. Below the tabs, the title 'WiFi Configuration' is displayed. Underneath, there are two input fields: 'Password Setting' and 'SSID dlink\_DWR-730'. At the bottom of the screen, there are two buttons: 'Back' on the left and 'Done' on the right.

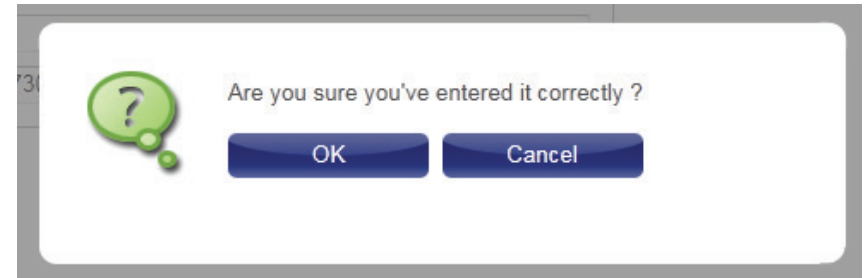

# Internet Connection

This page allows you to configure the Internet settings for your mobile network connection. Use the tabs in the left-hand column to navigate through the different settings categories.

## Connection Operation

**Flight Mode:** Flight mode turns off all communications so that the device can be powered on safely when in an aircraft. Select whether you want to **Enable** or **Disable** flight mode from the drop-down menu, and click **Change** to save the adjustment.

**Preferred Cellular Network:** Select your preferred cellular network connection mode:  
**Always On** - The router will automatically connect to your preferred mobile network and remain connected while the device is powered on.  
**Manual** - You must manually connect to the preferred mobile network.  
**On Demand** - The router will connect to the preferred mobile network when Internet access is required.

Click **Change** to save the adjustment.

**Roaming Mode:** Select whether you would like to **Enable** or **Disable** mobile network roaming from the drop-down menu.

**Caution:** Roaming on networks other than your own may incur additional usage charges.



**Connection:** Shows the type and status of the current mobile connection. To change the connection profile, select a user profile from the table below and click **Set** to activate the profile. Click **Disconnect** to manually disconnect the current mobile data service.

**Profiles:** The profiles table shows the details of currently configured user profiles. To add a new user profile, navigate to the **User Profile** tab at the top of this section.

The screenshot shows the mobile connection status at the top, indicating '2/3G Data Connection 1' is 'Connected' with a signal strength indicator and 'PID-7' selected. Below this is a table of user profiles:

Profile	Type	Name	APN	Protocol	User	Password
PID-7	System	(Far East one)	internet	IPv4		
PID-8	System	(Far East one) (Fetnet01)	fetnet01	IPv4		

Total Num : 2

## User Profile

Click **Add** to add a new user profile.

**Name:** Enter a name to identify the new user profile.

**APN:** Enter the Access Point Name (APN) for the connection. If you do not know this information, please contact your service provider.

**Protocol:** Select the protocol to be used for the connection from the drop-down menu.

**User:** Enter the username to be used for this connection.

**Password:** Enter the password to be used for this connection.

**Delete:** Click the delete icon to delete this profile from the list.

Click **OK** to save the profile.

Click **Apply** to apply the profile settings and return to the Internet menu.

The screenshot shows the 'User Profile' configuration screen with the following fields:

Profile	Name	APN	Protocol	User	Password
	<input type="text"/>	<input type="text"/>	IPv4	<input type="text"/>	<input type="text"/>

Total Num : 1

Buttons: Add, OK, Apply

## 2G/3G Modem

This section displays information about your 2G or 3G modem connection.

### Information

**Information:** Displays information about your 2G or 3G modem.

### Settings

**Network:** Select your preferred network type from the drop-down menu:

**Auto** - The modem will automatically select the modem type depending on the network it is connected to.

**3G Only** - The modem will only connect to 3G networks.

**2G Only** - The modem will only connect to 2G networks.

If you wish to change the network type, select your new network type and click **Change** to effect the change.

Re-enter the new PIN code.

Click **Apply** to apply the changes.

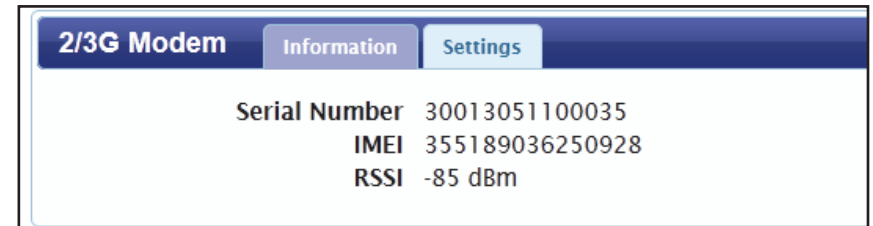

2/3G Modem Information Settings

Serial Number	30013051100035
IMEI	355189036250928
RSSI	-85 dBm

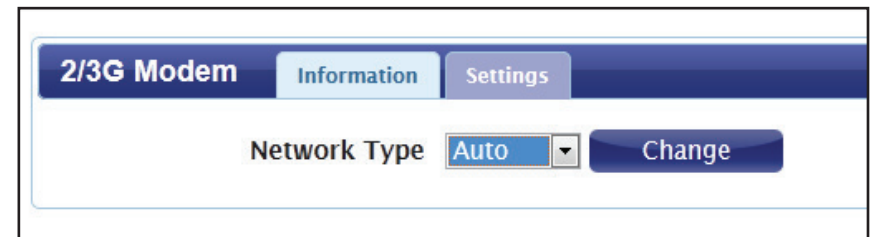

2/3G Modem Information Settings

Network Type

# SIM

This section allows you to turn SIM lock on or off for the SIM card which is currently inserted into the router.

**PIN Code:** Enter the PIN code for the SIM card. Click **Enable** to turn on SIM lock, or click **Disable** to turn off SIM lock.

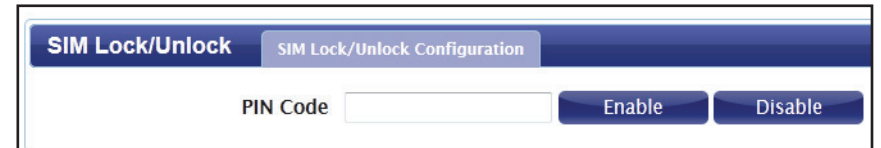

The screenshot shows a web interface for SIM Lock/Unlock Configuration. It features a dark blue header with two tabs: "SIM Lock/Unlock" and "SIM Lock/Unlock Configuration". Below the header, there is a label "PIN Code" followed by a text input field. To the right of the input field are two buttons: "Enable" and "Disable".



# PLMN

This page allows you to view available Public Land Mobile Networks (PLMN). This page can also be used to select a preferred network when you are roaming outside of your home network.

**Mode:** Select **Automatic** to allow the router to automatically connect to the first available network when roaming. Select **Manual** to choose your preferred roaming network from the list below.

If you have selected Manual mode, click on the preferred network to select it, and then click the **Update** button to select that network as the preferred network. Click **Query** to refresh the list of available networks.

**Note:** You will need to manually disconnect the current mobile data service before selecting a network using PLMN. Please refer to "Connection" on page 17 for further information on how to do this.



The screenshot shows a web interface for PLMN configuration. At the top, there is a tab labeled 'PLMN' and a sub-tab '2/3G Modem'. Below this, there is a 'Mode' dropdown menu currently set to 'Automatic'. Underneath, there is a table with the following columns: 'Status', 'PLMN number', 'Operator Name', and 'Access Technology'. Below the table, it says 'Total Num : 0'. At the bottom right of the interface, there are two buttons: 'Update' and 'Query'.

# Network

The **Network** pages allow you to check the current status of your Local Area Network (LAN), and make changes to LAN settings.

## Wi-Fi

This section allows you to configure the IP settings for your wireless network.

### IPv4

**IP Address:** Enter the IPv4 address for your Wi-Fi network. If you change this address, you will need to enter the new address in your web browser's address bar in order to access the web-based configuration utility.

**IP Subnet Mask:** Enter the IPv4 subnet mask for your Wi-Fi network.

Click **Apply** to save the current configuration.

### IPv6

**IPv6 Address:** Enter the IPv6 address for your Wi-Fi network.

**Prefix for LAN:** Enter the prefix to be used to delegate IPv6 addresses to the LAN.

**RA Autonomous:** Check the box to set the router announcement mode to autonomous.

**RA On-Link:** Check the box to enable router announcement on-link

Click **Apply** to save the current configuration.

### DNS Name

**DNS Device Name:** Enter your router's DNS device name in the field provided.

Click **Apply** to save the current configuration.

# DHCP

The DWR-730 has a built-in DHCP server which can assign IP addresses to connected clients. This section allows you to configure the DHCP settings.

## DHCP Server

**DHCP Mode:** Select **None** from the drop-down menu if you do not wish to enable the DHCP Server. Select **Server** to specify a DHCP server, and enter the information in the fields below.

**Start IP:** Set the starting address of the IP range.

**End IP:** Set the ending address of the IP range.

**Lease Time:** Set the lease time of the IP addresses issued by the DHCP server.

Click **Apply** to save the current configuration.

DHCP		DHCP Server	DNS Server	Static DHCP	Leased Hosts
DHCP Mode		Server			
Start IP		192.168.0.100			
End IP		192.168.0.199			
Lease Time		1440			

## DNS Server

**First/Second/Third DNS Server:** Select **None** from the drop-down menus if you do not wish to specify a first, second, or third DNS server. Select **User Define** to specify a DNS server, and enter the address of the server in the field provided.

Click **Apply** to save the current configuration.

DHCP		DHCP Server	DNS Server	Static DHCP	Leased Hosts
First DNS Server	None		0.0.0.0		
Second DNS Server	None		0.0.0.0		
Third DNS Server	None		0.0.0.0		

## Static DHCP

Use this option to specify a DHCP address reservation to a particular device or machine based on the MAC address. To add a new reservation, click **Add**.

**MAC Address:** Enter the MAC address of the device or machine for which you wish to make the DHCP reservation.

**IP Address:** Enter the IP address that you wish to reserve. This address must be within the DHCP address pool.

Click **OK** to save the reservation.

## Leased Hosts

This table shows the details of clients currently receiving a DHCP address from the DHCP server. Click **Refresh** to update the table.



The screenshot shows the 'Static DHCP' tab in a web interface. At the top, there are navigation tabs: DHCP, DHCP Server, DNS Server, Static DHCP, and Leased Hosts. Below the tabs is a table with columns: #, Status, MAC Address, and IP Address. The table is currently empty, with 'Total Num : 0' displayed below it. On the right side of the table, there are controls: a dropdown menu set to '10' per page, a 'page(P/1)' indicator, and buttons for 'Add', 'OK', and 'Delete All'. An 'Apply' button is located at the bottom right of the table area.



The screenshot shows the 'Leased Hosts' tab in the same web interface. The table now contains one entry. Below the table, 'Total Num : 1' is displayed. A 'Refresh' button is located at the bottom right of the table area.

#	Host Name	MAC Address	IP Address	Remaining Time
1	08083PCWIN7E	8C-44-35-07-C9-27	192.168.0.100	23:56:20

# NAT

This section allows you to configure functions related to Network Address Translation (NAT) such as port triggering and DMZ.

## Port Trigger

Use this option to have inbound traffic automatically forwarded to a dynamic address on the LAN when triggered by outbound traffic. To add a new port triggering rule, click **Add**.

**Active:** Check the box to activate this rule.

**Name:** Specify a name to identify the rule.

**Trigger Protocol:** Select **TCP** or **UDP** as the protocol for the trigger ports from the drop-down menu.

**Trigger Port:** Enter the starting and ending trigger port for the rule.

**Open Protocol:** Select **TCP** or **UDP** as the protocol for the ports to be opened from the drop-down menu.

**Open Port(s):** Enter the starting and ending ports to be opened when the trigger occurs.

**Delete:** Click the **Delete** icon to delete the rule.

Click **OK** to save the rule. Click **Apply** to apply the current rules and return to the Network page.

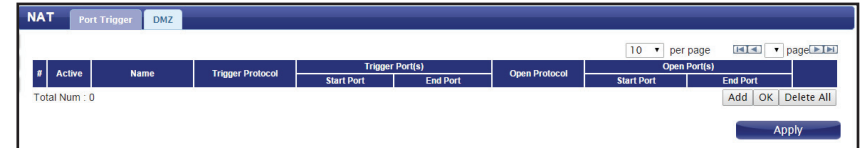

## DMZ

DMZ is short for Demilitarized Zone. Checking **DMZ Enable** will expose a chosen computer to the outside world by completely disabling all firewalls.

**Caution:** Only recommended for advanced users, enabling this option will potentially expose your computer to cyber attacks over the Internet.

**DMZ Host:** Enter the DMZ host IP address here.

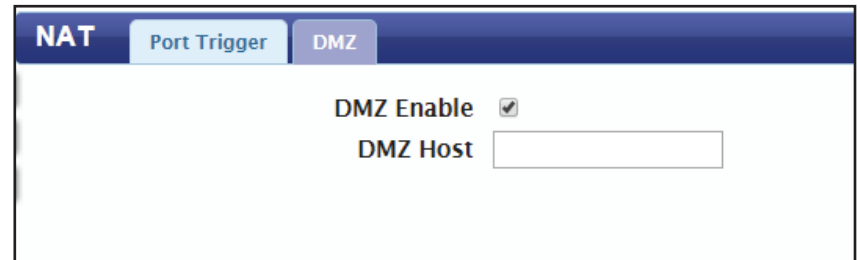

The screenshot shows a web interface for configuring NAT settings. At the top, there is a dark blue header with the text "NAT" on the left and two tabs: "Port Trigger" (highlighted in light blue) and "DMZ" (highlighted in a darker blue). Below the header, the "DMZ" configuration area is visible. It contains a label "DMZ Enable" followed by a checked checkbox icon. Below that is a label "DMZ Host" followed by an empty rectangular text input field.

# SMS

The DWR-730 can send and receive SMS text messages through the mobile network's SMS function. In this section you can check the SIM card's inbox and outbox, as well as send new messages.

## New Message

**Send To:** Enter the phone number that you wish to send the message to.

**Messages:** Enter the body of the message to be sent.

Click **Apply** to save the current configuration.

## Local

### Inbox

This tab shows a summary of SMS messages in the inbox.

### Outbox

This tab shows a summary of messages in the outbox which are yet to be sent.

Number	Message	Date/Time
Total Num : 0		

# Wi-Fi

The **Wi-Fi** pages allow you to check the current status of your Wi-Fi network, and make changes to Wi-Fi settings.

## Basic

This section allows you to configure your Wi-Fi network and specify the wireless security method to be used to secure your network.

**Enable** Check the box to enable the Wi-Fi function.

**Mode:** Select the desired 802.11 wireless mode from the drop-down menu. You should make your selection based on the standards supported by the wireless clients which will be connecting to your network.

**Channel:** To have the router automatically select the optimal wireless channel, select **Auto** from the drop-down menu. If you wish to select a particular channel, select it from the drop-down menu.

**802.11N** If you are using the 802.11n standard, you can manually select the channel width which best suits your network environment.

**TxPower:** Select the desired transmission power from the drop-down menu.

**Beacon Interval:** The beacon interval determines how often information about the wireless network is broadcast. It is recommended that you do not adjust this setting unless instructed to do so.

The screenshot shows the 'Basic' configuration page for Wi-Fi. The settings are as follows:

Setting	Value
Enable	<input checked="" type="checkbox"/>
Mode	802.11 B/G/N mixed
Channel	channel 11
802.11N Channel Width	HT20
TxPower	10 dBm
Beacon Interval (20 ~ 1024)	100
DTIM Period (1 ~ 255)	1
SSID	dlink_DWR-730
Hide SSID	<input type="checkbox"/>
Encryption Type	WPA Personal
WPA Mode	Auto(WPA or WPA2)
Cipher Type	AES
Pre-shared Key	1234567890

An 'Apply' button is located at the bottom right of the configuration area.



**DTIM Period:** The Delivery Traffic Indication Message broadcasts information about buffered data to clients that are currently in low-power mode. Enter the desired DTIM period as a number of beacon intervals.

**SSID:** Enter the SSID (network name) to identify your wireless network.

**Hide SSID:** Check the box to hide the SSID of your network. If the SSID is hidden, wireless clients must manually enter it in order to connect to your network.

**Encryption Type:** Select the wireless encryption method that you wish to use from the drop-down menu. Depending on the method that you select, you may need to configure additional settings. For more information regarding wireless encryption and how to configure it, please refer to “Wireless Security” on page 30. If you do not wish to enable wireless security, select **None** from the drop-down menu.

Click **Apply** to save the current settings.

The screenshot shows a configuration window titled "Basic" with the following settings:

- Enable:
- Mode: 802.11 B/G/N mixed
- Channel: channel 11
- 802.11N Channel Width: HT20
- TxPower: 10 dBm
- Beacon Interval (20 ~ 1024): 100
- DTIM Period (1 ~ 255): 1
- SSID: dlink\_DWR-730
- Hide SSID:
- Encryption Type: WPA Personal
- WPA Mode: Auto(WPA or WPA2)
- Cipher Type: AES
- Pre-shared Key: 1234567890

An "Apply" button is located at the bottom right of the window.

# Wireless Security

It is recommended that you enable wireless security on your router in order to protect your wireless network from unauthorized access. You should select a wireless security protocol that is compatible with the wireless clients which will be accessing your network.

## Wired Equivalent Privacy (WEP)

Wired Equivalent Privacy (WEP) is an older wireless security standard, which although providing more protection than no security at all, has some weaknesses which could make it vulnerable to intrusion. It is recommended that you only use WEP if your wireless clients do not support Wi-Fi Protected Access (WPA). WEP is not supported by the 802.11n standard, and therefore you will not be able to achieve 802.11n speeds if using WEP.

**Encryption Type:** Select **WEP** from the drop-down menu.

**Authentication Method:** Select the desired authentication method from the drop-down menu:

- Auto** - The router will automatically determine the authentication method based on the client that is connecting to it.
- Open System** - Clients do not require authentication in order to associate with the router. The encryption key will be used to encrypt data packets sent over the network.
- Shared** - The encryption key is used for authentication as well as to encrypt data packets.

**WEP Encryption Length:** Select the length of the encryption key to be used.

- Length: 64-bit** - A 64-bit key comprises a string of 10 hexadecimal characters, or 5 ASCII characters.
- 128-bit** - A 128-bit key comprises a string of 26 hexadecimal characters, or 13 ASCII characters.

**Key 1-4:** You can predetermine up to 4 WEP keys. Select the WEP key you wish to use by clicking on the radio buttons next to the keys. Select whether you wish to use **HEX** or **ASCII** characters in your key using the drop-down menu. Enter the desired key in the field provided. Click **Apply** to save the current settings.

<b>Encryption Type</b>	WEP	
<b>Authentication Method</b>	OPEN SYSTEM	
<b>WEP Encryption Length</b>	64-bit	
<input checked="" type="radio"/> <b>Key 1</b>	HEX	●●●●●●●●●●
<input type="radio"/> <b>Key 2</b>	HEX	●●●●●●●●●●
<input type="radio"/> <b>Key 3</b>	HEX	●●●●●●●●●●
<input type="radio"/> <b>Key 4</b>	HEX	●●●●●●●●●●

## Wi-Fi Protected Access (WPA)

Wi-Fi Protected Access (WPA) is a newer and more secure encryption protocol which makes significant improvements over WEP. There are two versions of WPA: the original WPA, and the newer WPA2.

**Encryption Type:** Select **WPA Personal** from the drop-down menu.

**WPA Mode:** Select the desired authentication method from the drop-down menu:  
**Auto (WPA or WPA2)** - The router will automatically determine the version of WPA to be used based on the client that is connecting to it.  
**WPA** - Clients will only be able to associate with the router using the WPA standard.  
**WPA2** - Clients will only be able to associate with the router using the WPA2 standard. Clients which do not support WPA2 will not be able to associate with the router.

**Cipher Type:** Select the desired cipher type from the drop-down menu:  
**TKIP** - This cipher is used by the WPA standard.  
**AES** - A newer cipher used by the WPA2 standard. Use of this cipher type is required in order to achieve 802.11 speeds.

**Pre-Shared Key** The pre-shared key is the password which clients will require in order to connect to your network. Enter a password of between 8 and 63 characters in length.

Click **Apply** to save the current settings

Encryption Type	WPA Personal ▾
WPA Mode	Auto(WPA or WPA2) ▾
Cipher Type	TKIP and AES ▾
Pre-shared Key	1234567890

## Wi-Fi Protected Setup (WPS)

Wi-Fi Protected Setup (WPS) enables you to quickly and securely add compatible devices to your wireless network.

**Enable:** Check the box to enable the Wi-Fi Protected Setup feature.

**Configure State:** Select whether you wish to **Configure** or **Unconfigure** the WPS function using the radio buttons.

**Configure Method:** Select the WPS method that you wish to use. If your device supports Push Button Connection (PBC), simply select this option and click **Apply** to start the connection process. You will then have 120 seconds to press the WPS button on your wireless device in order to initiate the connection. If your device does not support PBC, you can select the PIN method and continue to the next step.

**Current PIN:** A PIN is a unique number that can be used to add the router to an existing network or to create a new network.

**Generate PIN:** For extra security, a new PIN can be generated. Click **Generate** to create a new PIN. The current PIN will be shown in the field next to **Current PIN**. This PIN can be used by wireless clients to join your network using the PIN method.

**Enrollee PIN:** If the device you are trying to add to the network was provided with a PIN number, select this option and enter the device's PIN in the field.

Click **Apply** to commence the connection process.

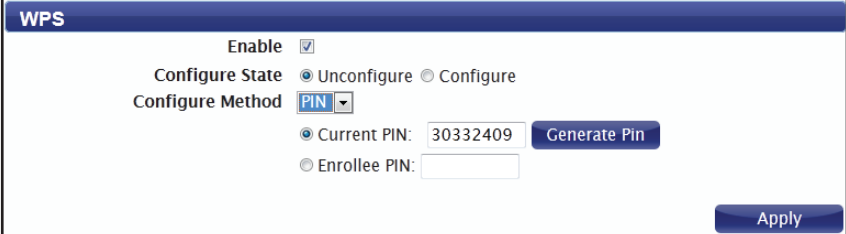

The screenshot shows the WPS configuration window. It has a title bar labeled 'WPS'. Inside, there are several settings: 'Enable' is checked with a checkbox; 'Configure State' has two radio buttons, 'Unconfigure' is selected and 'Configure' is unselected; 'Configure Method' is a dropdown menu currently set to 'PIN'; 'Current PIN' has a radio button selected and a text field containing '30332409' with a 'Generate Pin' button to its right; 'Enrollee PIN' has an unselected radio button and an empty text field. An 'Apply' button is located in the bottom right corner of the window.

# MAC Filter

The MAC filtering option allows you to allow or deny access to wireless clients based on their MAC address.

**Enable MAC Address Filter:** Check the box to enable the MAC filtering feature.

**Mode:** Select the filtering mode from the drop-down menu. You can choose to **Deny Listed Stations** access to your network, or **Allow Listed Stations** access.

## Listed Stations Table

To add a new filtering rule, click **Add**.

**Active:** Check the box to activate the rule.

**Name:** Enter a name to identify the machine or station which will be filtered.

**MAC Address:** Enter the MAC address of the machine or station which you wish to filter.

**Delete:** Click the **Delete** icon to delete the rule from the table.

Click **OK** to save the current rule and add it to the table.

Click **Apply** to save all changes and return to the Wi-Fi page.

#	Active	Name	MAC Address
1	<input checked="" type="checkbox"/>		00:00:00:00:00:00

## Station Lists

The Station List tab shows a list of all wireless clients currently connected to your wireless network.

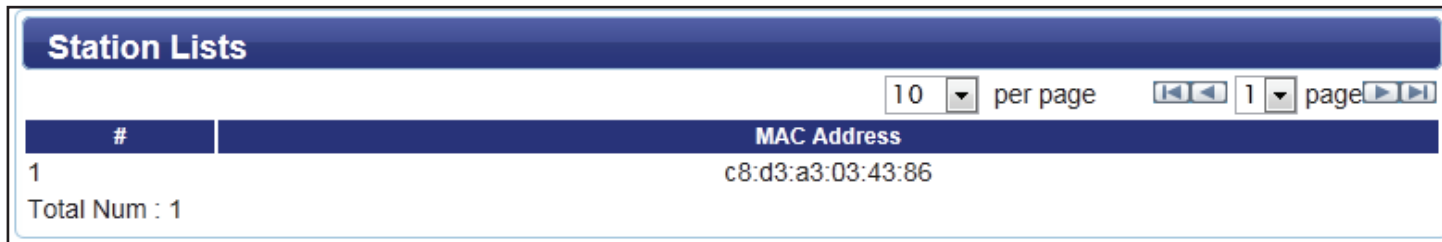

The screenshot shows a web interface titled "Station Lists". At the top right, there are pagination controls: a dropdown menu set to "10", the text "per page", a set of navigation arrows, a dropdown menu set to "1", and the text "page". Below this is a table with two columns: "#", which is highlighted in blue, and "MAC Address", which is also highlighted in blue. The table contains one row with the number "1" in the first column and the MAC address "c8:d3:a3:03:43:86" in the second column. Below the table, the text "Total Num : 1" is displayed.

#	MAC Address
1	c8:d3:a3:03:43:86

Total Num : 1

# Security

The Security tab allows you to configure your router's firewall settings and enable features to protect your network from outside intrusions and malicious attacks.

## Firewall

### IP Filter

Click **Add** to add a new filtering rule.

**Active:** Check the box to activate the IP filter rule.

**Source IP:** Enter the source IP address to be filtered.

**Source From Port:** Enter the starting port on the source IP.

**Source To Port:** Enter the ending port on the source IP.

**Destination IP:** Enter the destination IP address to be filtered.

**Destination From Port:** Enter the starting port of the destination IP.

**Destination To Port:** Enter the ending port of the destination IP.

**Protocol:** Select the protocol for the IP filter rule.

**Delete:** Click the icon to delete the IP filtering rule.

Click **OK** to save the filtering rule. Click **Apply** to save the current configuration.



## IPv6 Filter

Click **Add** to add a new filtering rule.

**Active:** Check the box to activate the IP filter rule.

**Source IP:** Enter the source IP address to be filtered.

**Source Port:** Enter the port for the source IP.

**Destination IP:** Enter the destination IP address to be filtered.

**Destination Port:** Enter the port on the destination IP.

**Protocol:** Select the protocol for the IP filter rule.

**Delete:** Click the icon to delete the IP filtering rule.

Click **OK** to save the current filtering rule. Click **Apply** to save the current configuration.

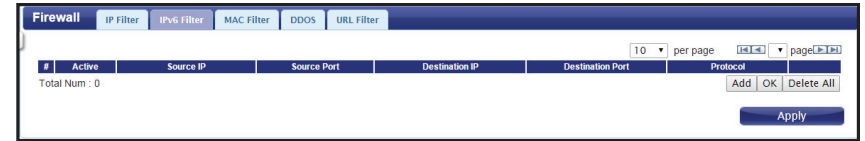



## MAC Filter

The MAC filter lets you to allow or deny access to your wireless network based on a client's MAC address.

Click **Add** to add a new MAC filtering rule.

**Blacklist/Whitelist:** Select **Blacklist** to deny access to only the MAC addresses listed below. Select **Whitelist** to allow access to only the MAC addresses listed below.

**Active:** Check the box to activate the MAC filter rule.

**Source MAC:** Enter the MAC address of the machine or device which you wish to filter packets coming from.

**Destination MAC:** Enter the MAC address of the machine you wish to filter packets.

**Day:** Check the box for each day that you wish to activate the MAC filtering rule.

**Start Time:** Enter the starting time at which you wish to activate the MAC filtering rule each day.

**End Time:** Enter the ending time at which you wish to deactivate the MAC filtering rule each day.

**Delete:** Click the icon to delete this MAC filtering rule.

Click **OK** to add the current rule to the rules list. Click **Apply** to save the current configuration.

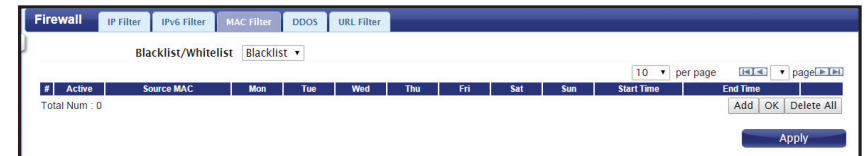

## DDOS

This section allows you to enable various security features to protect against Denial of Service (DoS) attacks.

**DoS Prevention** Check the box next to the rule to enable prevention against  
**Filters:** that specific kind of DoS attack.

Click **Apply** to save the current configuration.

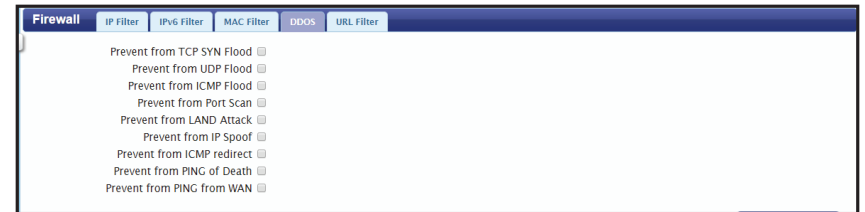

## URL Filter

The content filter allows you to allow or deny access to specific URLs.

**Enable URL Filter:** Check the box to enable URL filtering.

**Blacklist/Whitelist:** Select **Blacklist** to deny access to only URLs listed in the rule

table. Select **Whitelist** to allow access to only URLs listed in the rule list.

**Active:** Check the box to activate the URL filtering rule.

**URL:** Enter the URL that you wish to allow or deny access to. If you enter a domain name, all URLs under this domain will be allowed or denied access.

**Delete:** Click the icon to delete the rule.

Click **Add** to save the rule and add it to the rule table. Click **Apply** to save the current configuration.



# Application

This tab allows you to configure the router's administrative functions, such as time & date, remote access, and firmware. You can also access the system log.

## About

This tab shows the router's basic information.



# Configuration

## Backup

Click **Backup** to save the router's current configuration to a file on your computer. You will then be prompted with a "save file" dialogue, where you can choose where to save the configuration file.

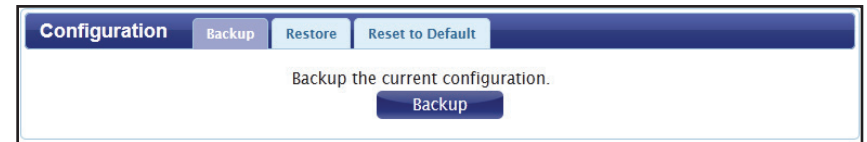

## Restore

Click **Browse** to locate a previously saved configuration file on your computer. Once you have located the file, click **Restore** to configure the router according to the selected configuration file.

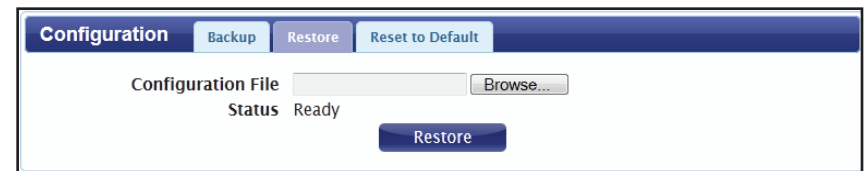

## Reset to Default

Click **Reset** to restore the router's settings to the factory defaults.

**Important:** All settings stored on the router will be lost following a factory reset.

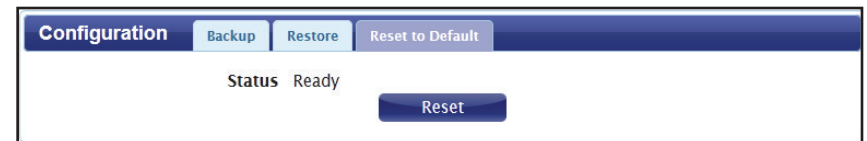

## Firmware Upgrade

You can upgrade the firmware of the router here. Make sure the firmware file you want to use is on the local hard drive of the computer. Please check your local D-Link support site or <http://support.dlink.com> for firmware updates and language packs.

Click **Browse** to locate a previously downloaded firmware file on your computer. Once the file has been located, click **Update** to carry out the firmware upgrade process.

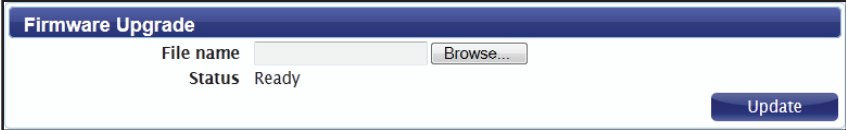

The screenshot shows a web interface titled "Firmware Upgrade". It contains a "File name" input field with a "Browse..." button next to it. Below the input field, the "Status" is displayed as "Ready". In the bottom right corner, there is a blue "Update" button.

**Important:** All current settings will be restored to their factory defaults following a firmware upgrade.

## Standby Mode

This section allows you to configure the router's automatic power-saving modes.

**Enable Auto Power Saving:** Check the box to enable the automatic power saving features.

**Enter Standby Mode:** Enter the number of minutes after which the router will enter standby mode if no activity is detected.

**Enter Hibernate Mode:** Enter the number of minutes after which the router will enter hibernate mode if no activity is detected.

**Auto Power Off:** Enter the number of minutes after which the router will shut down if no activity is detected.

Click **Apply** to save the current configuration.

Standby Mode	
Enable Auto Power Saving	<input checked="" type="checkbox"/>
Enter Standby Mode (minutes)	5
Enter Hibernate Mode (minutes)	5
Auto Power Off (minutes)	120

Apply

# Password

This page lets you change the configuration interface passwords for the Administrator (Admin) and User accounts.

**Select the user to change password:** Select whether you wish to change the password for the admin or user account from the drop down menu.

**Old Password:** Enter the existing password for this account.

**New Password:** Enter the new password for this account.

**Retype New Password:** Type the new password again to confirm.

Click **Apply** to save the current configuration.

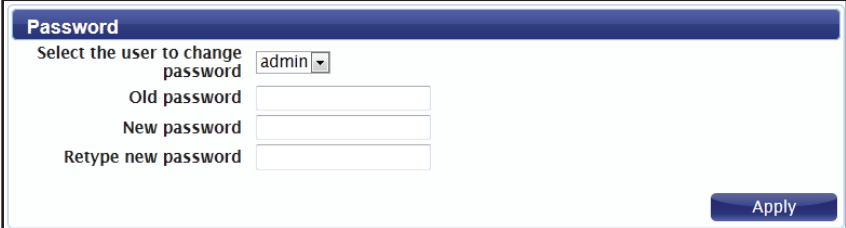

The screenshot shows a web interface titled "Password" with a blue header. Below the header, there are four input fields and a button. The first field is a dropdown menu labeled "Select the user to change password" with "admin" selected. The second field is labeled "Old password". The third field is labeled "New password". The fourth field is labeled "Retype new password". A blue "Apply" button is located in the bottom right corner of the form area.



# Date and Time

This page lets you set the time and date for your router, and also configure automatic time synchronization and daylight savings time.

## Date

**Current System Time:** Displays the current time and date according to the router's system clock.

**Mode:** Select **Manual** to manually set the time and date, or select **Get from Time Server** to have the router automatically synchronize the time with a Network Time Protocol (NTP) server.

**New Time:** If you selected Manual mode, enter the current time.

**New Date:** If you selected Manual mode, enter the current date.

**Time Protocol:** If you selected Get time From Server, select the desired time protocol from the drop-down menu.

**Time Server Address 1-4:** Enter up to four NTP server addresses which will be used to synchronize the router's system time and date.

Click **Apply** to save the current settings.

The screenshot shows the 'Date and Time' configuration page. The 'Date' tab is active. The 'Current System Time' is 'Mon Jun 10 15:45:41 2013'. The 'Mode' is set to 'Manual'. The 'New Time (hh:mm:ss)' is '15 : 45 : 41'. The 'New Date (mm-dd-yyyy)' is '6 / 10 / 2013'. There is an 'Apply' button at the bottom right.

The screenshot shows the 'Date and Time' configuration page. The 'Date' tab is active. The 'Current System Time' is 'Mon Jun 10 15:45:41 2013'. The 'Mode' is set to 'Get from Time Server'. The 'Time Protocol' is 'NTP (RFC-1305)'. There are four 'Time Server Address' fields, all containing '1.my.pool.ntp.org', '2.my.pool.ntp.org', '3.my.pool.ntp.org', and '4.my.pool.ntp.org' respectively. There is an 'Apply' button at the bottom right.

## Time Zone

**Time Zone:** Select your time zone from the drop-down menu.

**Enable Daylight Saving:** Check the box to enable automatic adjustment for daylight saving.

**Start Date:** Enter the details of the starting date and time for daylight saving time in your region.

**End Date:** Enter the details of the ending date and time for daylight saving time in your region.

Click **Apply** to save the current settings.

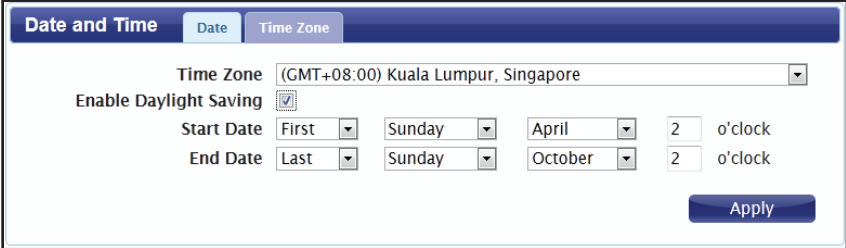

The screenshot shows a configuration window titled "Date and Time" with two tabs: "Date" and "Time Zone". The "Time Zone" tab is active. The settings are as follows:

- Time Zone:** (GMT+08:00) Kuala Lumpur, Singapore
- Enable Daylight Saving:**
- Start Date:** First, Sunday, April, 2 o'clock
- End Date:** Last, Sunday, October, 2 o'clock

An "Apply" button is located at the bottom right of the configuration area.

# Language

**Language:** Select your preferred language from the drop-down menu.

Click **Apply** to save the current configuration.



The screenshot shows a configuration window titled "Language". Inside the window, there is a label "Language" followed by a dropdown menu currently displaying "English". To the right of the dropdown menu is a blue button labeled "Apply".

# System Log

The system log displays a record of all events which occur while the router is running.

## Log Setting

**Enable Log:** Check the box to enable the router's log-keeping function.

Click **Apply** to save the current configuration.

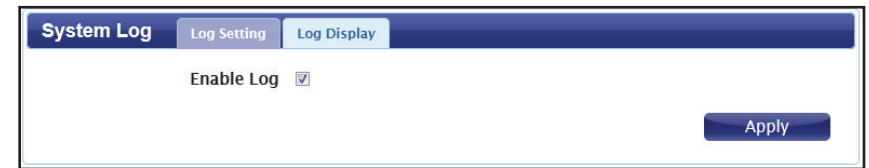

## Log Display

**Refresh:** Click to update the log display.

**Clear Log:** Click to clear all log entries.

**Display Log Level:** Select the level of log event which you wish to view from the drop-down menu.

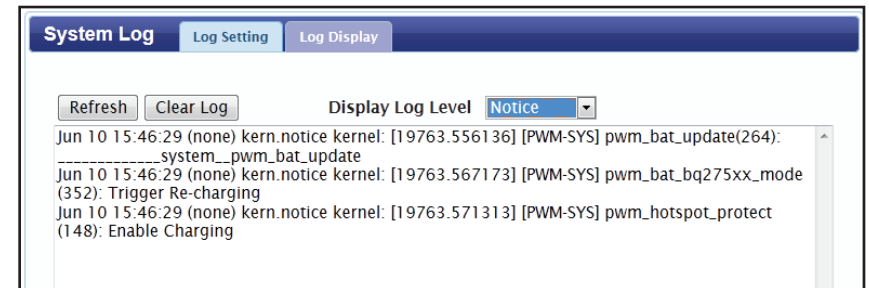

# Connecting to a Wireless Network Using Windows 10

When connecting to the DWR-730 wirelessly for the first time, you will need to know the default network name (SSID) and security key (Wi-Fi password) being used. These can be found on a label on the underside of the battery cover.

To join an existing network, locate the wireless network icon in the taskbar, next to the time display and click on it.

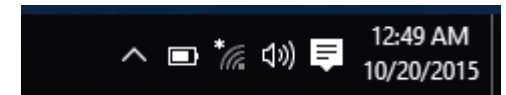

Wireless Icon

Clicking on this icon will display a list of wireless networks which are within connecting proximity of your computer. Select the desired network by clicking on the SSID.



To connect to the SSID, click **Connect**.

To automatically connect with the router when your device next detects the SSID, click the **Connect Automatically** check box.

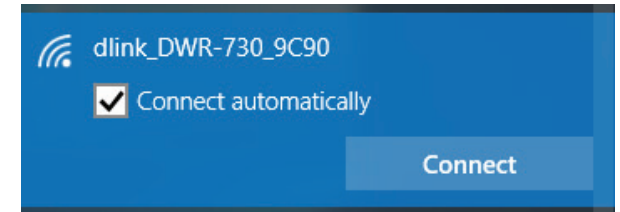

You will then be prompted to enter the network security key (Wi-Fi password) for the wireless network. Enter the password into the box and click **Next** to connect to the network.

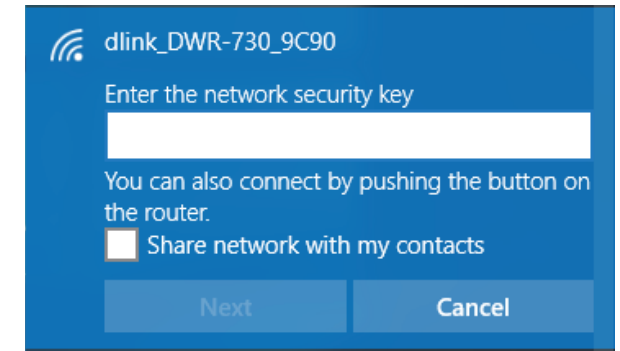

# Using Windows 8.1/8.0

It is recommended to enable wireless security (WPA/WPA2) on your wireless router or access point before configuring your wireless adapter. If you are joining an existing network, you will need to know the security key (Wi-Fi password) being used.

To join an existing network, locate the wireless network icon in the taskbar, next to the time display.



Clicking on this icon will display a list of wireless networks which are within connecting proximity of your computer. Select the desired network by clicking on the network name.

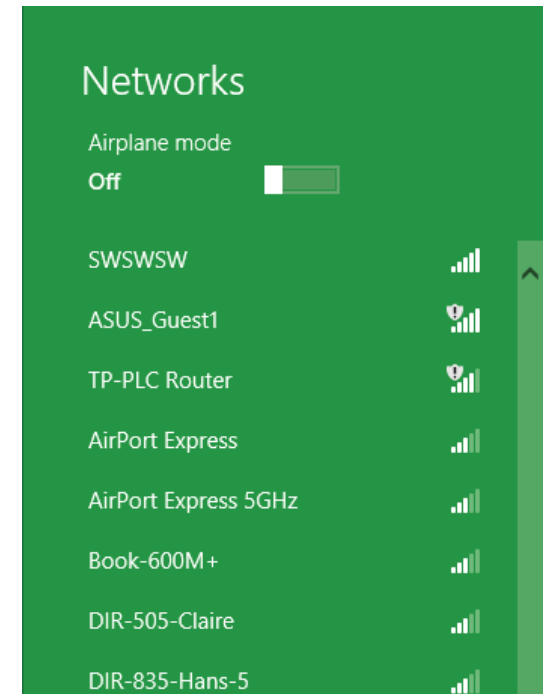

You will then be prompted to enter the network security key (Wi-Fi password) for the wireless network. Enter the password into the box and click Next.

If you wish to use Wi-Fi Protected Setup (WPS) to connect to the router, you can also press the WPS button on your router at this point to enable the WPS function.

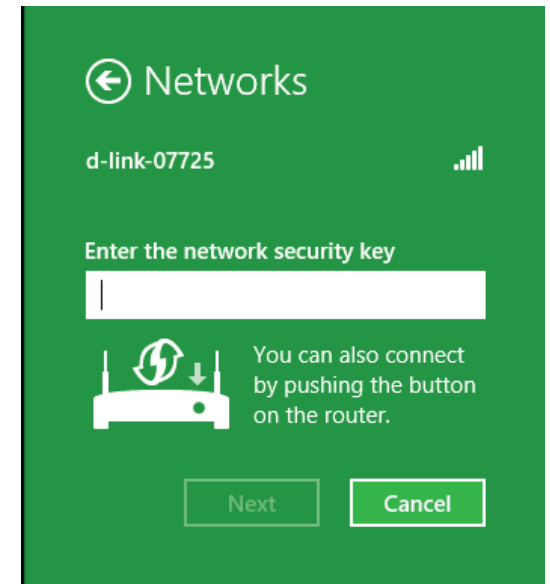

When you have established a successful connection to a wireless network, the word **Connected** will appear next to the name of the network to which you are connected.

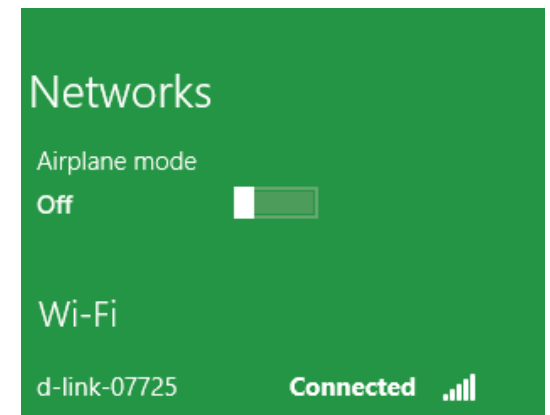



# Using Windows 7

Windows 7 users may use the built-in wireless utility to connect to a wireless network. If you are using another party's utility or Windows 2000, please refer to the user manual of your wireless adapter for help with connecting to a wireless network. Most utilities will have a "site survey" option similar to the Windows 7 utility as seen below.

If you receive the **Wireless Networks Detected** bubble, click on the center of the bubble to access the utility. You can also click on the wireless icon in your system tray (lower-right corner).

The utility will display any available wireless networks in your area.



Highlight the wireless network (SSID) you would like to connect to and click the **Connect** button.

If you get a good signal but cannot access the Internet, check your TCP/IP settings for your wireless adapter. Refer to “Networking Basics” on page 70 for more information.



## Configuring Wireless Security

It is recommended to enable wireless security (WPA/WPA2) on your wireless router or access point before configuring your wireless adapter. If you are joining an existing network, you will need to know the security key or passphrase being used.

Click on the wireless icon in your system tray (lower-right corner).

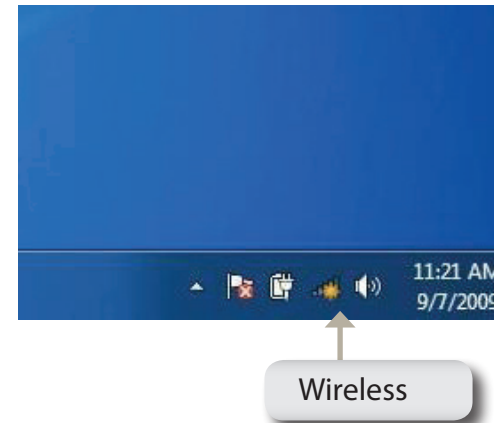

The utility will display any available wireless networks in your area.

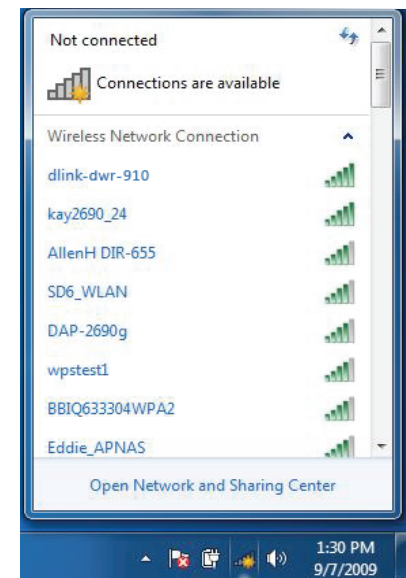

Highlight the wireless network (SSID) you would like to connect to and click the **Connect** button.



The following window appears while your computer tries to connect to the router.

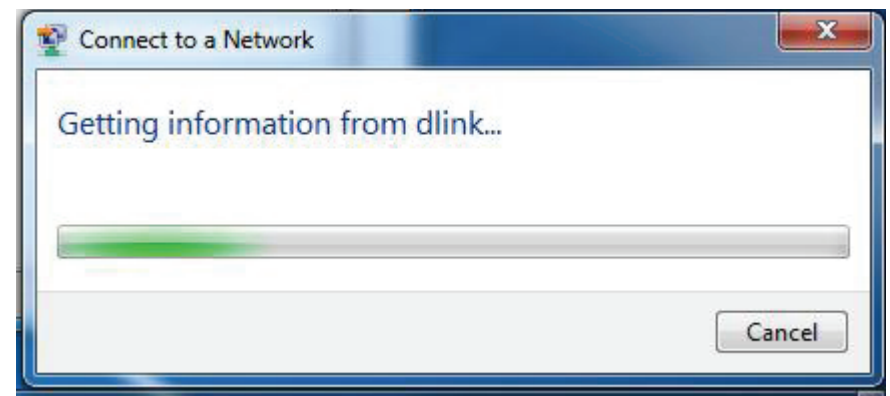

Enter the same security key or passphrase that is on your router and click **Connect**.

It may take 20-30 seconds to connect to the wireless network. If the connection fails, please verify that the security settings are correct. The key or passphrase must be exactly the same as on the wireless router.

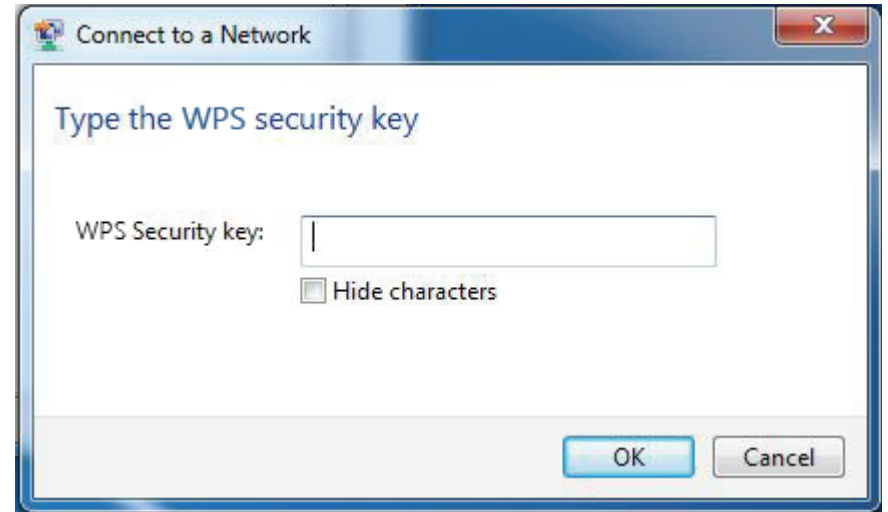

# Using Windows Vista™

Windows® Vista™ users may use the built-in wireless utility. If you are using another party's utility or Windows® 2000, please refer to the user manual of your wireless adapter for help with connecting to a wireless network. Most utilities will have a "site survey" option similar to the Windows® Vista™ utility as seen below.

If you receive the **Wireless Networks Detected** bubble, click on the center of the bubble to access the utility.

or

Right-click on the wireless computer icon in your system tray (lower-right corner next to the time). Select **Connect to a network**.

The utility will display any available wireless networks in your area. Click on a network (displayed using the SSID) and click the **Connect** button.

If you get a good signal but cannot access the Internet, check the TCP/IP settings for your wireless adapter. Refer to "Networking Basics" on page 70 for more information.

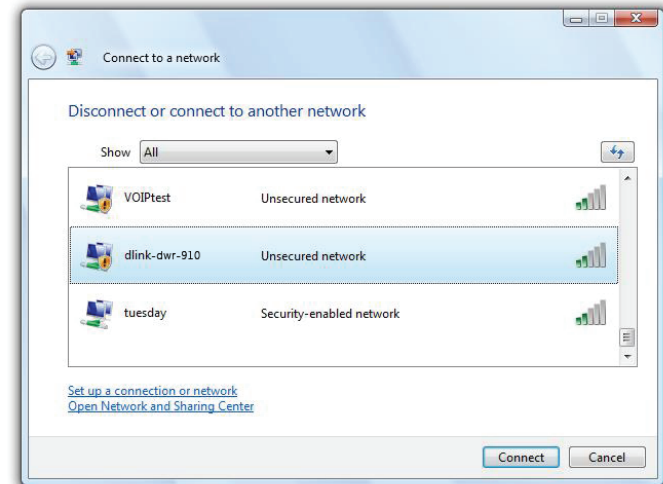

## Configuring Wireless Security

It is recommended to enable wireless security (WEP/WPA/WPA2) on your wireless router or access point before configuring your wireless adapter. If you are joining an existing network, you will need to know the security key or passphrase being used.

Open the Windows® Vista™ Wireless Utility by right-clicking on the wireless computer icon in your system tray (lower right corner of screen). Select **Connect to a network**.



Highlight the wireless network (SSID) you would like to connect to and click **Connect**.

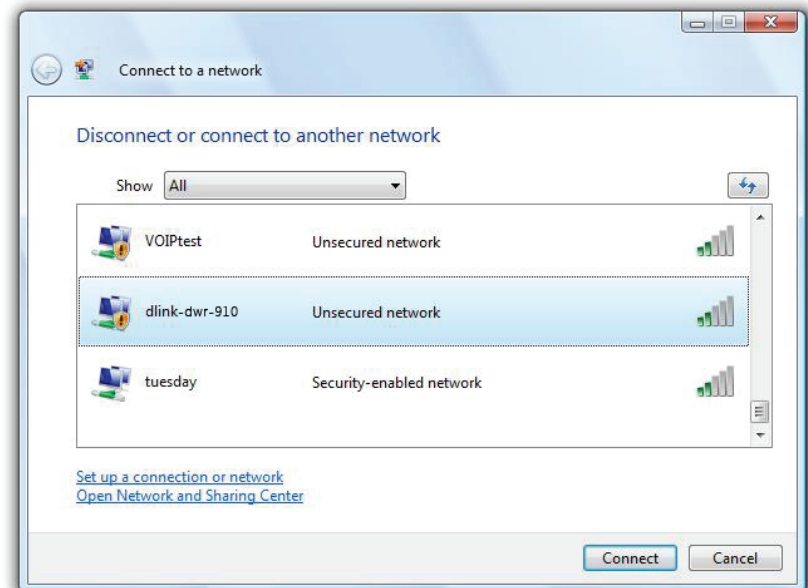

Enter the same security key or passphrase that is on your router and click **Connect**.

It may take 20-30 seconds to connect to the wireless network. If the connection fails, please verify that the security settings are correct. The key or passphrase must be exactly the same as on the wireless router.





# Connect to a Wireless Network Using Windows® XP

Windows® XP users may use the built-in wireless utility (Zero Configuration Utility). The following instructions are for Service Pack 2 users. If you are using another party's utility or Windows® 2000, please refer to the user manual of your wireless adapter for help with connecting to a wireless network. Most utilities will have a "site survey" option similar to the Windows® XP utility as seen below.

If you receive the **Wireless Networks Detected** bubble, click on the center of the bubble to access the utility.

or

Right-click on the wireless computer icon in your system tray (lower-right corner next to the time). Select **View Available Wireless Networks**.

The utility will display any available wireless networks in your area. Click on a network (displayed using the SSID) and click the **Connect** button.

If you get a good signal but cannot access the Internet, check the TCP/IP settings for your wireless adapter. Refer to "Networking Basics" on page 70 for more information.

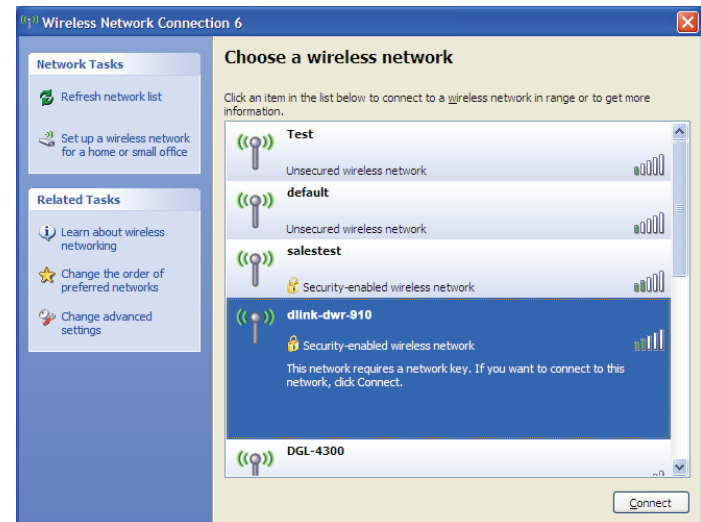
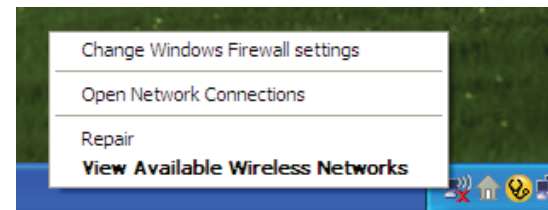
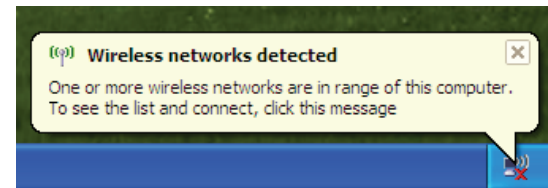

# Configure WEP

It is recommended to enable WEP on your wireless router or access point before configuring your wireless adapter. If you are joining an existing network, you will need to know the WEP key being used.

1. Open the Windows® XP Wireless Utility by right-clicking on the wireless computer icon in your system tray (lower-right corner of screen). Select **View Available Wireless Networks**.

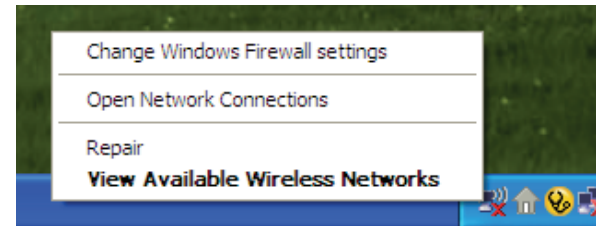

2. Highlight the wireless network (SSID) you would like to connect to and click **Connect**.

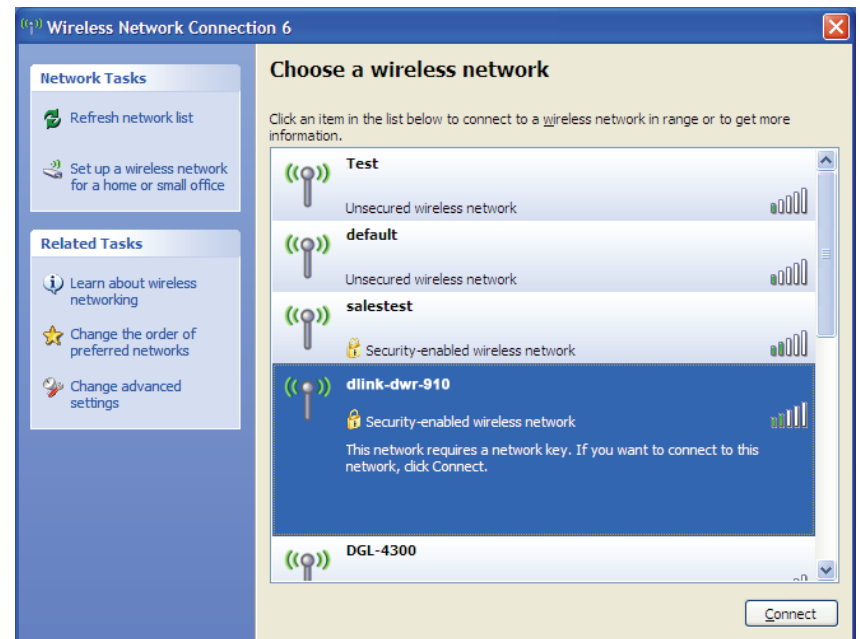

3. The **Wireless Network Connection** box will appear. Enter the same WEP key that is on your router and click **Connect**.

It may take 20-30 seconds to connect to the wireless network. If the connection fails, please verify that the WEP settings are correct. The WEP key must be exactly the same as on the wireless router.

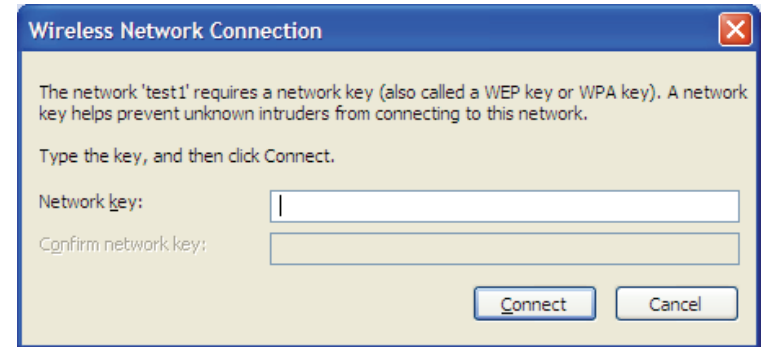

## Configure WPA-PSK

It is recommended to enable WPA on your wireless router or access point before configuring your wireless adapter. If you are joining an existing network, you will need to know the WPA key being used.

1. Open the Windows® XP Wireless Utility by right-clicking on the wireless computer icon in your system tray (lower-right corner of screen). Select **View Available Wireless Networks**.

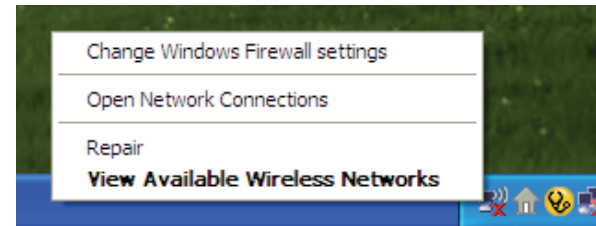

2. Highlight the wireless network (SSID) you would like to connect to and click **Connect**.

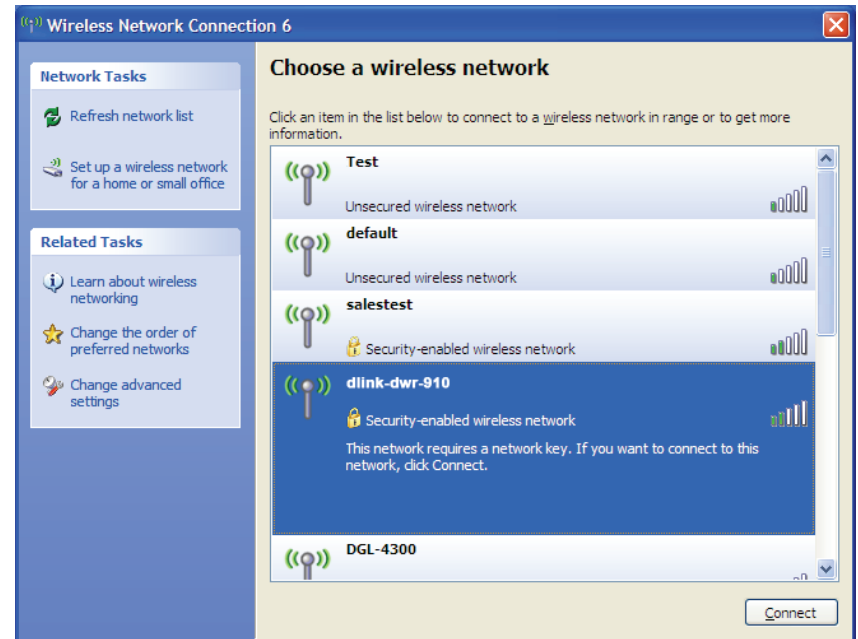

3. The **Wireless Network Connection** box will appear. Enter the WPA-PSK passphrase and click **Connect**.

It may take 20-30 seconds to connect to the wireless network. If the connection fails, please verify that the WPA-PSK settings are correct. The WPA-PSK passphrase must be exactly the same as on the wireless router.

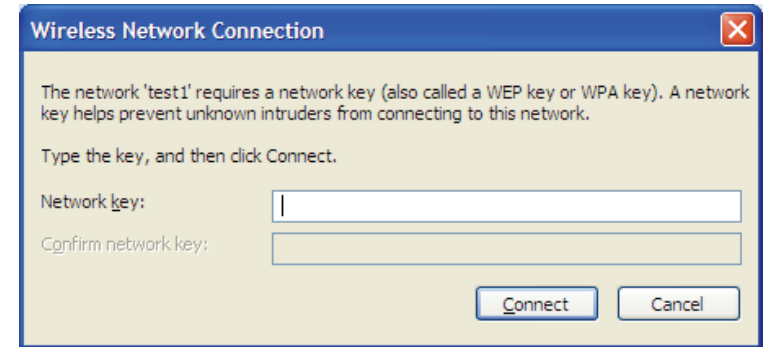

# Using Mac OS

It is recommended to enable wireless security (WPA/WPA2) on your wireless router or access point before configuring your wireless adapter. If you are joining an existing network, you will need to know the security key (Wi-Fi password) being used.

To quickly access your Wi-Fi information and settings, click the Wi-Fi icon on the menu bar.

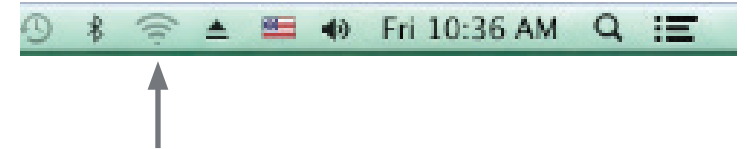

Clicking on this icon will display a list of all wireless networks within range of your computer. Select the desired network by clicking on the network name.



You will then be prompted to enter the network security key (Wi-Fi password) for the wireless network. Enter the password into the box and click **Join**.

**Note:** To avoid having to enter your network security key each time you connect, check **Remember this network**.



Once the connection is successfully established, you will see a check by the name of your wireless network.

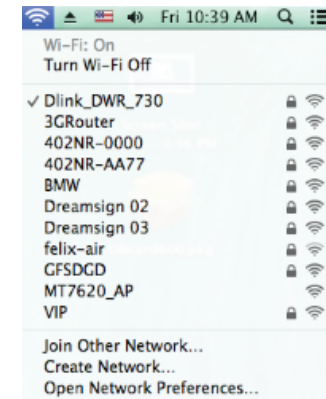

# Troubleshooting

This chapter provides solutions to problems that can occur during the installation and operation of the DWR-730. Read the following descriptions if you are having problems.

## 1. Why can't I access the web-based configuration utility?

When entering the IP address of your router (192.168.0.1 for example), you are not connecting to a website on the Internet or have to be connected to the Internet. The device has the utility built-in to a ROM chip in the device itself. Your computer must be on the same IP subnet to connect to the web-based utility.

- Make sure you have an updated Java-enabled web browser. We recommend the following:
  - Internet Explorer 7 or higher, Chrome 20, Firefox 12.0, or Safari 5.0.
- If attempting to connect wirelessly, ensure that the wireless icon on the OLED display is showing. Also, ensure that you are connected to the correct SSID for your mobile router.
- Make sure that the computer you are using is not connected to any other devices (such as routers or switches) which might have the same IP address as the DWR-730, as this may cause an IP address conflict. If you have a conflict, temporarily unplug any other devices from your computer while you configure the DWR-730. You can also change the IP address of the DWR-730 in the Network section of the configuration utility. Please refer to "Wi-Fi" on page 22 for further information on changing the IP address. You may also need to renew your computer's IP address configuration. To do this, start the Command utility: Click on **Start > Run**. In the run box type **cmd** and click **OK**. (Windows Vista users type **cmd** in the **Start Search** box.) This will bring up a black screen with white text. At the command prompt, type **ipconfig /release** and wait for the process to be completed. Next, type **ipconfig /renew** which will renew your computer's IP address configuration.
- Disable any Internet security software running on the computer. Software firewalls such as ZoneAlarm, BlackICE, Sygate, Norton Personal Firewall, and Windows® XP firewall may block access to the configuration pages. Check the help files included with your firewall software for more information on disabling or configuring it.



- Configure your Internet settings:
  - Go to **Start > Settings > Control Panel**. Double-click the **Internet Options** icon. From the **Security** tab, click the **Default Level** button to restore the settings to their defaults.
  - Click the **Connection** tab and set the dial-up option to **Never Dial a Connection**. Click the **LAN Settings** button. Make sure nothing is checked. Click **OK**.
  - Go to the **Advanced** tab and click the button to restore these settings to their defaults. Click **OK** three times.
  - Close your web browser (if open) and re-open it.

## 2. What can I do if I forgot my password?

If you forgot your password, you must reset your router. Please note that this process will change all your settings back to the factory defaults.

To reset the router, first remove the back cover of the router to expose the battery. Using a paperclip or similar object, press and hold the reset button, which is located inside the hole to the upper-left of the SIM card slot (see diagram). The DWR-730 will restore the factory default settings. Wait about 30 seconds for the router to restart before you attempt to reconnect to it. The default IP address is 192.168.0.1 and the default username is **admin**. The password should be left blank.

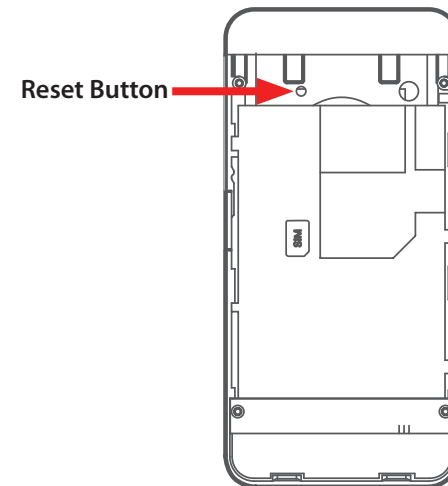

# Networking Basics

## Check your IP address

After you install your new D-Link adapter, by default, the TCP/IP settings should be set to obtain an IP address from a DHCP server (i.e. wireless router) automatically. To verify your IP address, please follow the steps below.

Click on **Start > Run**. In the run box type *cmd* and click **OK**. (Windows® Vista™ users type *cmd* in the **Start Search** box.)

Type *ipconfig* and press **Enter**.

This will display the IP address, subnet mask, and the default gateway of your adapter.

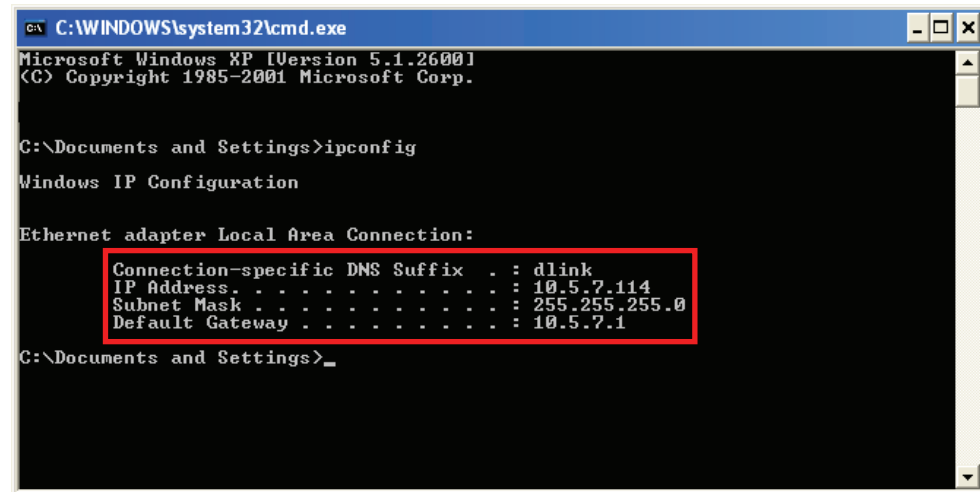

```
C:\WINDOWS\system32\cmd.exe
Microsoft Windows XP [Version 5.1.2600]
(C) Copyright 1985-2001 Microsoft Corp.

C:\Documents and Settings>ipconfig

Windows IP Configuration

Ethernet adapter Local Area Connection:

    Connection-specific DNS Suffix . : dlink
    IP Address . . . . . : 10.5.7.114
    Subnet Mask . . . . . : 255.255.255.0
    Default Gateway . . . . . : 10.5.7.1

C:\Documents and Settings>_
```

If the address is 0.0.0.0, check your adapter installation, security settings, and the settings on your router. Some firewall software programs may block a DHCP request on newly installed adapters.

## Assign a Static IP address

If you are not using a DHCP capable gateway/router or you need to assign a static IP address, please follow the steps below:

### Step 1

- Windows® 8 Click on **Start > Control Panel > Network and Internet Connections > Network Connections > Configure your Internet Protocol (IP) settings.**
- Windows® 7 Click on **Start > Control Panel > Network and Internet > Network and Sharing Center > Manage Network Connections.**
- Windows® Vista™ Click on **Start > Control Panel > Network and Internet > Network and Sharing Center > Manage Network Connections.**
- Windows® XP Click on **Start > Control Panel > Network Connections.**

### Step 2

Right-click on the **Local Area Connection** which represents your network adapter and select **Properties.**

### Step 3

Highlight **Internet Protocol (TCP/IP)** and click **Properties.**

### Step 4

Click **Use the following IP address** and enter an IP address that is on the same subnet as your network or the LAN IP address on your router.

**Example:** If the router's LAN IP address is 192.168.0.1, make your IP address 192.168.0.X where X is a number between 2 and 99. Make sure that the number you choose is not in use on the network. Set **Default Gateway** the same as the LAN IP address of your router (192.168.0.1).

Set **Primary DNS** the same as the LAN IP address of your router (192.168.0.1). The **Secondary DNS** is not needed or you may enter a DNS server from your ISP.

### Step 5

Click **OK** twice to save your settings.

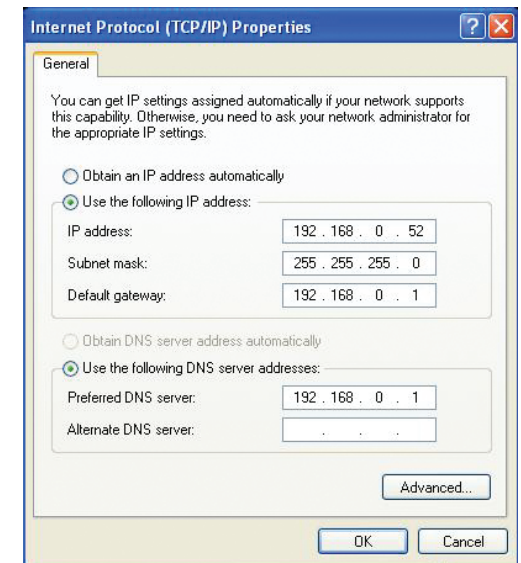

# Technical Specifications

## Radio Frequency Bands

- HSPA/HSPDA/UMTS: 900/2100 MHz
- EDGE/GPRS/GSM: 850/900/1800/2100 MHz
- Power Class 3 (+23 dBm)

## Cellular Access

- HSPA+
  - Downlink: 21 Mbps
  - Uplink: 5.76 Mbps

## Wi-Fi Access Point

- 802.11n (150 Mbps compatible)
- 802.11g (54 Mbps)
- 802.11b (11 Mbps)

## Antenna

- One internal antenna

## USB Interface

- micro USB port

## USIM Slot

- Standard 6-pin SIM card interface

## Status Indicators

- OLED display

## Storage

- microSD card slot

## Wireless Security

- 64/128-bit WEP (Wired Equivalent Privacy)
- WPA & WPA2 (Wi-Fi Protected Access)
- WAPI (WLAN Authentication and Privacy Infrastructure)

## Firewall

- Network Address Translation (NAT)

## Dimensions (L x W x H)

- 100.30 x 49.35 x 14.13 mm (3.95 x 1.94 x 0.56 inches)

## Weight

- 90 g (3.17 ounces)

## Operating Temperature

- -10 to 55 °C (14 to 131 °F)

## Certifications

- CE

# Regulatory Information

## EU Battery & WEEE Directives Disposal and Recycling

This product may contain a battery. Recycle or dispose of batteries in accordance with the battery manufacturer's instructions and local/national disposal and recycling regulations. For more information, please refer to the warranty guide.

### 電池警語

廢電池請回收。



廢電池請回收



	<b>Frequency Band(s)</b> <b>Frequenzband</b> <b>Fréquence bande(s)</b> <b>Bandas de Frecuencia</b> <b>Frequenza/e</b> <b>Frequentie(s)</b>	<b>Max. Output Power (EIRP)</b> <b>Max. Output Power</b> <b>Consommation d'énergie max.</b> <b>Potencia máxima de Salida</b> <b>Potenza max. Output</b> <b>Max. Output Power</b>
2.4 G	2.4 – 2.4835 GHz	100 mW

## European Community Declaration of Conformity:

Česky [Czech]	Tímto D-Link Corporation prohlašuje, že tento produkt, jeho příslušenství a software jsou v souladu se směrnicí 2014/53/EU. Celý text ES prohlášení o shodě vydaného EU a o firmwaru produktu lze stáhnout na stránkách k produktu <a href="http://www.dlink.com">www.dlink.com</a> .
Dansk [Danish]	D-Link Corporation erklærer herved, at dette produkt, tilbehør og software er i overensstemmelse med direktiv 2014/53/EU. Den fulde tekst i EU-overensstemmelseserklæringen og produktfirmware kan wnloades fra produktsiden hos <a href="http://www.dlink.com">www.dlink.com</a> .
Deutsch [German]	Hiermit erklärt die D-Link Corporation, dass dieses Produkt, das Zubehör und die Software der Richtlinie 2014/53/EU entsprechen. Der vollständige Text der Konformitätserklärung der Europäischen Gemeinschaft sowie die Firmware zum Produkt stehen Ihnen zum Herunterladen von der Produktseite im Internet auf <a href="http://www.dlink.com">www.dlink.com</a> zur Verfügung.
Eesti [Estonian]	Käesolevaga kinnitab D-Link Corporation, et see toode, tarvikud ja tarkvara on kooskõlas direktiiviga 2014/53/EL. Euroopa Liidu vastavusdeklaratsiooni täistekst ja toote püsivara on allalaadimiseks saadaval tootelehel <a href="http://www.dlink.com">www.dlink.com</a> .
English	Hereby, D-Link Corporation, declares that this product, accessories, and software are in compliance with directive 2014/53/EU. The full text of the EU Declaration of Conformity and product firmware are available for download from the product page at <a href="http://www.dlink.com">www.dlink.com</a>
Español [Spanish]	Por la presente, D-Link Corporation declara que este producto, accesorios y software cumplen con las directivas 2014/53/UE. El texto completo de la declaración de conformidad de la UE y el firmware del producto están disponibles y se pueden descargar desde la página del producto en <a href="http://www.dlink.com">www.dlink.com</a> .
Ελληνική [Greek]	Με την παρούσα, η D-Link Corporation δηλώνει ότι αυτό το προϊόν, τα αξεσουάρ και το λογισμικό συμμορφώνονται με την Οδηγία 2014/53/ΕΕ. Το πλήρες κείμενο της δήλωσης συμμόρφωσης της ΕΕ και το υλικολογισμικό του προϊόντος είναι διαθέσιμα για λήψη από τη σελίδα του προϊόντος στην τοποθεσία <a href="http://www.dlink.com">www.dlink.com</a> .
Français [French]	Par les présentes, D-Link Corporation déclare que ce produit, ces accessoires et ce logiciel sont conformes aux directives 2014/53/UE. Le texte complet de la déclaration de conformité de l'UE et le microprogramme du produit sont disponibles au téléchargement sur la page des produits à <a href="http://www.dlink.com">www.dlink.com</a> .
Italiano [Italian]	Con la presente, D-Link Corporation dichiara che questo prodotto, i relativi accessori e il software sono conformi alla direttiva 2014/53/UE. Il testo completo della dichiarazione di conformità UE e il firmware del prodotto sono disponibili per il download dalla pagina del prodotto su <a href="http://www.dlink.com">www.dlink.com</a> .

Latviski [Latvian]	Ar šo uzņēmums D-Link Corporation apliecina, ka šis produkts, piederumi un programmatūra atbilst direktīvai 2014/53/ES. ES atbilstības deklarācijas pilno tekstu un produkta aparātprogrammatūru var lejupielādēt attiecīgā produkta lapā vietnē <a href="http://www.dlink.com">www.dlink.com</a> .
Lietuvių [Lithuanian]	Šiuo dokumentu „D-Link Corporation“ pareiškia, kad šis gaminys, priedai ir programinė įranga atitinka direktyvą 2014/53/ES. Visą ES atitikties deklaracijos tekstą ir gaminio programinę aparatinę įrangą galima atsisiųsti iš gaminio puslapio adresu <a href="http://www.dlink.com">www.dlink.com</a> .
Nederlands [Dutch]	Hierbij verklaart D-Link Corporation dat dit product, accessoires en software voldoen aan de richtlijnen 2014/53/EU. De volledige tekst van de EU conformiteitsverklaring en productfirmware is beschikbaar voor download van de productpagina op <a href="http://www.dlink.com">www.dlink.com</a> .
Malti [Maltese]	Bil-preżenti, D-Link Corporation tiddikjara li dan il-prodott, l-aċċessorji, u s-software huma konformi mad-Direttiva 2014/53/UE. Tista' tniżżel it-test sħiħ tad-dikjarazzjoni ta' konformità tal-UE u l-firmware tal-prodott mill-paġna tal-prodott fuq <a href="http://www.dlink.com">www.dlink.com</a> .
Magyar [Hungarian]	Ezennel a D-Link Corporation kijelenti, hogy a jelen termék, annak tartozékai és szoftvere megfelelnek a 2014/53/EU sz. rendeletnek. Az EU Megfelelőségi nyilatkozat teljes szövege és a termék firmware a termék oldaláról tölthető le a <a href="http://www.dlink.com">www.dlink.com</a> címen.
Polski [Polish]	D-Link Corporation niniejszym oświadcza, że ten produkt, akcesoria oraz oprogramowanie są zgodne z dyrektywami 2014/53/EU. Pełen tekst deklaracji zgodności UE oraz oprogramowanie sprzętowe do produktu można pobrać na stronie produktu w witrynie <a href="http://www.dlink.com">www.dlink.com</a> .
Português [Portuguese]	Desta forma, a D-Link Corporation declara que este produto, os acessórios e o software estão em conformidade com a diretiva 2014/53/UE. O texto completo da declaração de conformidade da UE e do firmware
Slovensko[Slovenian]	Podjetje D-Link Corporation s tem izjavlja, da so ta izdelek, dodatna oprema in programnska oprema skladni z direktivami 2014/53/EU. Celotno besedilo izjave o skladnosti EU in vdelana programska oprema sta na voljo za prenos na strani izdelka na <a href="http://www.dlink.com">www.dlink.com</a> .
Slovensky [Slovak]	Spoločnosť D-Link týmto vyhlasuje, že tento produkt, príslušenstvo a softvér sú v súlade so smernicou 214/53/EÚ. Úplné znenie vyhlásenia EÚ o zhode a firmvéri produktu sú k dispozícii na prevzatie zo stránky produktu <a href="http://www.dlink.com">www.dlink.com</a> .
Suomi [Finnish]	D-Link Corporation täten vakuuttaa, että tämä tuote, lisävarusteet ja ohjelmisto ovat direktiivin 2014/53/EU vaatimusten mukaisia. Täydellinen EU-vaatimustenmukaisuusvakuutus samoin kuin tuotteen laiteohjelmisto ovat ladattavissa osoitteesta <a href="http://www.dlink.com">www.dlink.com</a> .

Svenska [Swedish]	D-Link Corporation försäkrar härmed att denna produkt, tillbehör och programvara överensstämmer med direktiv 2014/53/EU. Hela texten med EU-försäkran om överensstämmelse och produkt-firmware kan hämtas från produktsidan på <a href="http://www.dlink.com">www.dlink.com</a> .
Íslenska [Icelandic]	Hér með lýsir D-Link Corporation því yfir að þessi vara, fylgihlutir og hugbúnaður eru í samræmi við tilskipun 2014/53/EB. Sækja má ESB-samræmisýfirlýsinguna í heild sinni og fastbúnað vörunnar af vefsíðu vörunnar á <a href="http://www.dlink.com">www.dlink.com</a> .
Norsk [Norwegian]	Herved erklærer D-Link Corporation at dette produktet, tilbehøret og programvaren er i samsvar med direktivet 2014/53/EU. Den fullstendige teksten i EU-erklæring om samsvar og produktets fastvare er tilgjengelig for nedlasting fra produktsiden på <a href="http://www.dlink.com">www.dlink.com</a> .

**Warning Statement:**

The power outlet should be near the device and easily accessible.



### **NOTICE OF WIRELESS RADIO LAN USAGE IN THE EUROPEAN COMMUNITY (FOR WIRELESS PRODUCT ONLY):**

- This device is restricted to indoor use when operated in the European Community using channels in the 5.15-5.35 GHz band to reduce the potential for interference.
- This device is a 2.4 GHz wideband transmission system (transceiver), intended for use in all EU member states and EFTA countries. This equipment may be operated in AL, AD, BE, BG, DK, DE, FI, FR, GR, GW, IS, IT, HR, LI, LU, MT, MK, MD, MC, NL, NO, AT, PL, PT, RO, SM, SE, RS, SK, ES, CI, HU, and CY.

#### **Usage Notes:**

- To remain in conformance with European National spectrum usage regulations, frequency and channel limitations will be applied on the products according to the country where the equipment will be deployed.
- This device is restricted from functioning in Ad-hoc mode while operating in 5 GHz. Ad-hoc mode is direct peer-to-peer communication between two client devices without an Access Point.
- Access points will support DFS (Dynamic Frequency Selection) and TPC (Transmit Power Control) functionality as required when operating in 5 GHz band within the EU.
- Please refer to the product manual or datasheet to check whether your product uses 2.4 GHz and/or 5 GHz wireless.

### **HINWEIS ZUR VERWENDUNG VON DRAHTLOS-NETZWERK (WLAN) IN DER EUROPÄISCHEN GEMEINSCHAFT ( NUR FÜR EIN DRAHTLOSES PRODUKT )**

- Der Betrieb dieses Geräts in der Europäischen Gemeinschaft bei Nutzung von Kanälen im 5,15-5,35 GHz Frequenzband ist ausschließlich auf Innenräume beschränkt, um das Interferenzpotential zu reduzieren.
- Bei diesem Gerät handelt es sich um ein zum Einsatz in allen EU-Mitgliedsstaaten und in EFTA-Ländern - ausgenommen Frankreich. Der Betrieb dieses Geräts ist in den folgenden Ländern erlaubt: AL, AD, BE, BG, DK, DE, FI, FR, GR, GW, IS, IT, HR, LI, LU, MT, MK, MD, MC, NL, NO, AT, PL, PT, RO, SM, SE, RS, SK, ES, CI, HU, CY

#### **Gebrauchshinweise:**

- Um den in Europa geltenden nationalen Vorschriften zum Nutzen des Funkspektrums weiterhin zu entsprechen, werden Frequenz und Kanalbeschränkungen, dem jeweiligen Land, in dem das Gerät zum Einsatz kommt, entsprechend, auf die Produkte angewandt.
- Die Funktionalität im Ad-hoc-Modus bei Betrieb auf 5 GHz ist für dieses Gerät eingeschränkt. Bei dem Ad-hoc-Modus handelt es sich um eine Peer-to-Peer-Kommunikation zwischen zwei Client-Geräten ohne einen Access Point.
- Access Points unterstützen die Funktionen DFS (Dynamic Frequency Selection) und TPC (Transmit Power Control) wie erforderlich bei Betrieb auf 5 GHz innerhalb der EU.
- Bitte schlagen Sie im Handbuch oder Datenblatt nach, ob Ihr Gerät eine 2,4 GHz und / oder 5 GHz Verbindung nutzt.

## **AVIS CONCERNANT L'UTILISATION DE LA RADIO SANS FIL LAN DANS LA COMMUNAUTÉ EUROPÉENNE (UNIQUEMENT POUR LES PRODUITS SANS FIL)**

- Cet appareil est limité à un usage intérieur lorsqu'il est utilisé dans la Communauté européenne sur les canaux de la bande de 5,15 à 5,35 GHz afin de réduire les risques d'interférences.
- Cet appareil est un système de transmission à large bande (émetteur-récepteur) de 2,4 GHz, destiné à être utilisé dans tous les États-membres de l'UE et les pays de l'AELE. Cet équipement peut être utilisé dans les pays suivants : AL, AD, BE, BG, DK, DE, FI, FR, GR, GW, IS, IT, HR, LI, LU, MT, MK, MD, MC, NL, NO, AT, PL, PT, RO, SM, SE, RS, SK, ES, CI, HU, CY

### **Notes d'utilisation:**

- Pour rester en conformité avec la réglementation nationale européenne en matière d'utilisation du spectre, des limites de fréquence et de canal seront appliquées aux produits selon le pays où l'équipement sera déployé.
- Cet appareil ne peut pas utiliser le mode Ad-hoc lorsqu'il fonctionne dans la bande de 5 GHz. Le mode Adhoc fournit une communication directe pair à pair entre deux périphériques clients sans point d'accès.
- Les points d'accès prendront en charge les fonctionnalités DFS (Dynamic Frequency Selection) et TPC (Transmit Power Control) au besoin lors du fonctionnement dans la bande de 5 GHz au sein de l'UE.
- Merci de vous référer au guide d'utilisation ou de la fiche technique afin de vérifier si votre produit utilise 2.4 GHz et/ou 5 GHz sans fil.

## **AVISO DE USO DE LA LAN DE RADIO INALÁMBRICA EN LA COMUNIDAD EUROPEA (SOLO PARA EL PRODUCTO INALÁMBRICO)**

- El uso de este dispositivo está restringido a interiores cuando funciona en la Comunidad Europea utilizando canales en la banda de 5,15-5,35 GHz, para reducir la posibilidad de interferencias.
- Este dispositivo es un sistema de transmisión (transceptor) de banda ancha de 2,4 GHz, pensado para su uso en todos los estados miembros de la UE y en los países de la AELC. Este equipo se puede utilizar en AL, AD, BE, BG, DK, DE, FI, FR, GR, GW, IS, IT, HR, LI, LU, MT, MK, MD, MC, NL, NO, AT, PL, PT, RO, SM, SE, RS, SK, ES, CI, HU, CY

### **Notas de uso:**

- Para seguir cumpliendo las normas europeas de uso del espectro nacional, se aplicarán limitaciones de frecuencia y canal en los productos en función del país en el que se pondrá en funcionamiento el equipo.
- Este dispositivo tiene restringido el funcionamiento en modo Ad-hoc mientras funcione a 5 Ghz. El modo Ad-hoc es la comunicación directa de igual a igual entre dos dispositivos cliente sin un punto de acceso.
- Los puntos de acceso admitirán la funcionalidad DFS (Selección de frecuencia dinámica) y TPC (Control de la potencia de transmisión) si es necesario cuando funcionan a 5 Ghz dentro de la UE.
- Por favor compruebe el manual o la ficha de producto para comprobar si el producto utiliza las bandas inalámbricas de 2.4 GHz y/o la de 5 GHz.

### **AVVISO PER L'USO DI LAN RADIO WIRELESS NELLA COMUNITÀ EUROPEA (SOLO PER PRODOTTI WIRELESS)**

- Nella Comunità europea, l'uso di questo dispositivo è limitato esclusivamente agli ambienti interni sui canali compresi nella banda da 5,15 a 5,35 GHz al fine di ridurre potenziali interferenze. Questo dispositivo è un sistema di trasmissione a banda larga a 2,4 GHz (ricetrasmittente), destinato all'uso in tutti gli stati membri dell'Unione europea e nei paesi EFTA.
- Questo dispositivo può essere utilizzato in AL, AD, BE, BG, DK, DE, FI, FR, GR, GW, IS, IT, HR, LI, LU, MT, MK, MD, MC, NL, NO, AT, PL, PT, RO, SM, SE, RS, SK, ES, CI, HU, CY

#### **Note per l'uso**

- Al fine di mantenere la conformità alle normative nazionali europee per l'uso dello spettro di frequenze, saranno applicate limitazioni sulle frequenze e sui canali per il prodotto in conformità alle normative del paese in cui il dispositivo viene utilizzato.
- Questo dispositivo non può essere attivato in modalità Ad-hoc durante il funzionamento a 5 GHz. La modalità Ad-hoc è una comunicazione diretta peer-to-peer fra due dispositivi client senza un punto di accesso.
- I punti di accesso supportano le funzionalità DFS (Dynamic Frequency Selection) e TPC (Transmit Power Control) richieste per operare a 5 GHz nell'Unione europea.
- Ti invitiamo a fare riferimento al manuale del prodotto o alla scheda tecnica per verificare se il tuo prodotto utilizza le frequenze 2,4 GHz e/o 5 GHz.

### **KENNISGEVING VAN DRAADLOOS RADIO LAN-GEbruik IN DE EUROPESE GEMEENSCHAP (ALLEEN VOOR DRAADLOOS PRODUCT)**

- Dit toestel is beperkt tot gebruik binnenshuis wanneer het wordt gebruikt in de Europese Gemeenschap gebruik makend van kanalen in de 5.15-5.35 GHz band om de kans op interferentie te beperken.
- Dit toestel is een 2.4 GHz breedband transmissiesysteem (transceiver) dat bedoeld is voor gebruik in alle EU lidstaten en EFTA landen. Deze uitrusting mag gebruikt worden in AL, AD, BE, BG, DK, DE, FI, FR, GR, GW, IS, IT, HR, LI, LU, MT, MK, MD, MC, NL, NO, AT, PL, PT, RO, SM, SE, RS, SK, ES, CI, HU, CY

#### **Gebruiksaanwijzingen:**

- Om de gebruiksvoorschriften van het Europese Nationale spectrum na te leven, zullen frequentie- en kanaalbeperkingen worden toegepast op de producten volgens het land waar de uitrusting gebruikt zal worden.
- Dit toestel kan niet functioneren in Ad-hoc mode wanneer het gebruikt wordt in 5 GHz. Ad-hoc mode is directe peer-to-peer communicatie tussen twee klantenapparaten zonder een toegangspunt.
- Toegangspunten ondersteunen DFS (Dynamic Frequency Selection) en TPC (Transmit Power Control) functionaliteit zoals vereist bij gebruik in 5 GHz binnen de EU.
- Raadpleeg de handleiding of de datasheet om te controleren of uw product gebruik maakt van 2.4 GHz en/of 5 GHz.

## **SAFETY INSTRUCTIONS**

The following general safety guidelines are provided to help ensure your own personal safety and protect your product from potential damage. Remember to consult the product user instructions for more details.

- Static electricity can be harmful to electronic components. Discharge static electricity from your body (i.e. touching grounded bare metal) before touching the product.
- Do not attempt to service the product and never disassemble the product. For some products with a user replaceable battery, please read and follow the instructions in the user manual.
- Do not spill food or liquid on your product and never push any objects into the openings of your product.
- Do not use this product near water, areas with high humidity, or condensation unless the product is specifically rated for outdoor application.
- Keep the product away from radiators and other heat sources.
- Always unplug the product from mains power before cleaning and use a dry lint free cloth only.

## **SICHERHEITSVORSCHRIFTEN**

Die folgenden allgemeinen Sicherheitsvorschriften dienen als Hilfe zur Gewährleistung Ihrer eigenen Sicherheit und zum Schutz Ihres Produkts. Weitere Details finden Sie in den Benutzeranleitungen zum Produkt.

- Statische Elektrizität kann elektronischen Komponenten schaden. Um Schäden durch statische Aufladung zu vermeiden, leiten Sie elektrostatische Ladungen von Ihrem Körper ab, (z. B. durch Berühren eines geerdeten blanken Metallteils), bevor Sie das Produkt berühren.
- Unterlassen Sie jeden Versuch, das Produkt zu warten, und versuchen Sie nicht, es in seine Bestandteile zu zerlegen. Für einige Produkte mit austauschbaren Akkus lesen Sie bitte das Benutzerhandbuch und befolgen Sie die dort beschriebenen Anleitungen.
- Vermeiden Sie, dass Speisen oder Flüssigkeiten auf Ihr Produkt gelangen, und stecken Sie keine Gegenstände in die Gehäuseschlitze oder -öffnungen Ihres Produkts.
- Verwenden Sie dieses Produkt nicht in unmittelbarer Nähe von Wasser und nicht in Bereichen mit hoher Luftfeuchtigkeit oder Kondensation, es sei denn, es ist speziell zur Nutzung in Außenbereichen vorgesehen und eingestuft.
- Halten Sie das Produkt von Heizkörpern und anderen Quellen fern, die Wärme erzeugen.
- Trennen Sie das Produkt immer von der Stromzufuhr, bevor Sie es reinigen und verwenden Sie dazu ausschließlich ein trockenes fusselfreies Tuch.

## CONSIGNES DE SÉCURITÉ

Les consignes générales de sécurité ci-après sont fournies afin d'assurer votre sécurité personnelle et de protéger le produit d'éventuels dommages. Veuillez consulter les consignes d'utilisation du produit pour plus de détails.

- L'électricité statique peut endommager les composants électroniques. Déchargez l'électricité statique de votre corps (en touchant un objet en métal relié à la terre par exemple) avant de toucher le produit.
- N'essayez pas d'intervenir sur le produit et ne le démontez jamais. Pour certains produits contenant une batterie remplaçable par l'utilisateur, veuillez lire et suivre les consignes contenues dans le manuel d'utilisation.
- Ne renversez pas d'aliments ou de liquide sur le produit et n'insérez jamais d'objets dans les orifices.
- N'utilisez pas ce produit à proximité d'un point d'eau, de zones très humides ou de condensation sauf si le produit a été spécifiquement conçu pour une application extérieure.
- Éloignez le produit des radiateurs et autres sources de chaleur.
- Débranchez toujours le produit de l'alimentation avant de le nettoyer et utilisez uniquement un chiffon sec non pelucheux.

## INSTRUCCIONES DE SEGURIDAD

Las siguientes directrices de seguridad general se facilitan para ayudarle a garantizar su propia seguridad personal y para proteger el producto frente a posibles daños. No olvide consultar las instrucciones del usuario del producto para obtener más información.

- La electricidad estática puede resultar nociva para los componentes electrónicos. Descargue la electricidad estática de su cuerpo (p. ej., tocando algún metal sin revestimiento conectado a tierra) antes de tocar el producto.
- No intente realizar el mantenimiento del producto ni lo desmonte nunca. Para algunos productos con batería reemplazable por el usuario, lea y siga las instrucciones del manual de usuario.
- No derrame comida o líquidos sobre el producto y nunca deje que caigan objetos en las aberturas del mismo.
- No utilice este producto cerca del agua, en zonas con humedad o condensación elevadas a menos que el producto esté clasificado específicamente para aplicación en exteriores.
- Mantenga el producto alejado de los radiadores y de otras fuentes de calor.
- Desenchufe siempre el producto de la alimentación de red antes de limpiarlo y utilice solo un paño seco sin pelusa.

## **ISTRUZIONI PER LA SICUREZZA**

Le seguenti linee guida sulla sicurezza sono fornite per contribuire a garantire la sicurezza personale degli utenti e a proteggere il prodotto da potenziali danni. Per maggiori dettagli, consultare le istruzioni per l'utente del prodotto.

- L'elettricità statica può essere pericolosa per i componenti elettronici. Scaricare l'elettricità statica dal corpo (ad esempio toccando una parte metallica collegata a terra) prima di toccare il prodotto.
- Non cercare di riparare il prodotto e non smontarlo mai. Per alcuni prodotti dotati di batteria sostituibile dall'utente, leggere e seguire le istruzioni riportate nel manuale dell'utente.
- Non versare cibi o liquidi sul prodotto e non spingere mai alcun oggetto nelle aperture del prodotto.
- Non usare questo prodotto vicino all'acqua, in aree con elevato grado di umidità o soggette a condensa a meno che il prodotto non sia specificatamente approvato per uso in ambienti esterni.
- Tenere il prodotto lontano da caloriferi e altre fonti di calore.
- Scollegare sempre il prodotto dalla presa elettrica prima di pulirlo e usare solo un panno asciutto che non lasci filacce.

## **VEILIGHEIDSINFORMATIE**

De volgende algemene veiligheidsinformatie werd verstrekt om uw eigen persoonlijke veiligheid te waarborgen en uw product te beschermen tegen mogelijke schade. Denk eraan om de gebruikersinstructies van het product te raadplegen voor meer informatie.

- Statische elektriciteit kan schadelijk zijn voor elektronische componenten. Ontlaad de statische elektriciteit van uw lichaam (d.w.z. het aanraken van geaard bloot metaal) voordat u het product aanraakt.
- U mag nooit proberen het product te onderhouden en u mag het product nooit demonteren. Voor sommige producten met door de gebruiker te vervangen batterij, dient u de instructies in de gebruikershandleiding te lezen en te volgen.
- Mors geen voedsel of vloeistof op uw product en u mag nooit voorwerpen in de openingen van uw product duwen.
- Gebruik dit product niet in de buurt van water, gebieden met hoge vochtigheid of condensatie, tenzij het product specifiek geclassificeerd is voor gebruik buitenshuis.
- Houd het product uit de buurt van radiators en andere warmtebronnen.
- U dient het product steeds los te koppelen van de stroom voordat u het reinigt en gebruik uitsluitend een droge pluisvrije doek.

## Disposing and Recycling Your Product

### ENGLISH

EN



This symbol on the product or packaging means that according to local laws and regulations this product should be not be disposed of in household waste but sent for recycling. Please take it to a collection point designated by your local authorities once it has reached the end of its life, some will accept products for free. By recycling the product and its packaging in this manner you help to conserve the environment and protect human health.

### D-Link and the Environment

At D-Link, we understand and are committed to reducing any impact our operations and products may have on the environment. To minimise this impact D-Link designs and builds its products to be as environmentally friendly as possible, by using recyclable, low toxic materials in both products and packaging.

D-Link recommends that you always switch off or unplug your D-Link products when they are not in use. By doing so you will help to save energy and reduce CO2 emissions.

To learn more about our environmentally responsible products and packaging please visit [www.dlinkgreen.com](http://www.dlinkgreen.com).

### DEUTSCH

DE



Dieses Symbol auf dem Produkt oder der Verpackung weist darauf hin, dass dieses Produkt gemäß bestehender örtlicher Gesetze und Vorschriften nicht über den normalen Hausmüll entsorgt werden sollte, sondern einer Wiederverwertung zuzuführen ist. Bringen Sie es bitte zu einer von Ihrer Kommunalbehörde entsprechend amtlich ausgewiesenen Sammelstelle, sobald das Produkt das Ende seiner Nutzungsdauer erreicht hat. Für die Annahme solcher Produkte erheben einige dieser Stellen keine Gebühren. Durch ein auf diese Weise durchgeführtes Recycling des Produkts und seiner Verpackung helfen Sie, die Umwelt zu schonen und die menschliche Gesundheit zu schützen.

### D-Link und die Umwelt

D-Link ist sich den möglichen Auswirkungen seiner Geschäftstätigkeiten und seiner Produkte auf die Umwelt bewusst und fühlt sich verpflichtet, diese entsprechend zu mindern. Zu diesem Zweck entwickelt und stellt D-Link seine Produkte mit dem Ziel größtmöglicher Umweltfreundlichkeit her und verwendet wiederverwertbare, schadstoffarme Materialien bei Produktherstellung und Verpackung.

D-Link empfiehlt, Ihre Produkte von D-Link, wenn nicht in Gebrauch, immer auszuschalten oder vom Netz zu nehmen. Auf diese Weise helfen Sie, Energie zu sparen und CO2-Emissionen zu reduzieren.

Wenn Sie mehr über unsere umweltgerechten Produkte und Verpackungen wissen möchten, finden Sie entsprechende Informationen im Internet unter [www.dlinkgreen.com](http://www.dlinkgreen.com).

**FRANÇAIS****FR**

Ce symbole apposé sur le produit ou son emballage signifie que, conformément aux lois et réglementations locales, ce produit ne doit pas être éliminé avec les déchets domestiques mais recyclé. Veuillez le rapporter à un point de collecte prévu à cet effet par les autorités locales; certains accepteront vos produits gratuitement. En recyclant le produit et son emballage de cette manière, vous aidez à préserver l'environnement et à protéger la santé de l'homme.

**D-Link et l'environnement**

Chez D-Link, nous sommes conscients de l'impact de nos opérations et produits sur l'environnement et nous engageons à le réduire. Pour limiter cet impact, D-Link conçoit et fabrique ses produits de manière aussi écologique que possible, en utilisant des matériaux recyclables et faiblement toxiques, tant dans ses produits que ses emballages.

D-Link recommande de toujours éteindre ou débrancher vos produits D-Link lorsque vous ne les utilisez pas. Vous réaliserez ainsi des économies d'énergie et réduirez vos émissions de CO<sub>2</sub>.

Pour en savoir plus sur les produits et emballages respectueux de l'environnement, veuillez consulter le [www.dlinkgreen.com](http://www.dlinkgreen.com).

**ESPAÑOL****ES**

Este símbolo en el producto o el embalaje significa que, de acuerdo con la legislación y la normativa local, este producto no se debe desechar en la basura doméstica sino que se debe reciclar. Llévelo a un punto de recogida designado por las autoridades locales una vez que ha llegado al fin de su vida útil; algunos de ellos aceptan recogerlos de forma gratuita. Al reciclar el producto y su embalaje de esta forma, contribuye a preservar el medio ambiente y a proteger la salud de los seres humanos.

**D-Link y el medio ambiente**

En D-Link, comprendemos y estamos comprometidos con la reducción del impacto que puedan tener nuestras actividades y nuestros productos en el medio ambiente. Para reducir este impacto, D-Link diseña y fabrica sus productos para que sean lo más ecológicos posible, utilizando materiales reciclables y de baja toxicidad tanto en los productos como en el embalaje.

D-Link recomienda apagar o desenchufar los productos D-Link cuando no se estén utilizando. Al hacerlo, contribuirá a ahorrar energía y a reducir las emisiones de CO<sub>2</sub>.

Para obtener más información acerca de nuestros productos y embalajes ecológicos, visite el sitio [www.dlinkgreen.com](http://www.dlinkgreen.com).



**ITALIANO****IT**

La presenza di questo simbolo sul prodotto o sulla confezione del prodotto indica che, in conformità alle leggi e alle normative locali, questo prodotto non deve essere smaltito nei rifiuti domestici, ma avviato al riciclo. Una volta terminato il ciclo di vita utile, portare il prodotto presso un punto di raccolta indicato dalle autorità locali. Alcuni questi punti di raccolta accettano gratuitamente i prodotti da riciclare. Scegliendo di riciclare il prodotto e il relativo imballaggio, si contribuirà a preservare l'ambiente e a salvaguardare la salute umana.

**D-Link e l'ambiente**

D-Link cerca da sempre di ridurre l'impatto ambientale dei propri stabilimenti e dei propri prodotti. Allo scopo di ridurre al minimo tale impatto, D-Link progetta e realizza i propri prodotti in modo che rispettino il più possibile l'ambiente, utilizzando materiali riciclabili a basso tasso di tossicità sia per i prodotti che per gli imballaggi.

D-Link raccomanda di spegnere sempre i prodotti D-Link o di scollegarne la spina quando non vengono utilizzati. In questo modo si contribuirà a risparmiare energia e a ridurre le emissioni di anidride carbonica.

Per ulteriori informazioni sui prodotti e sugli imballaggi D-Link a ridotto impatto ambientale, visitate il sito all'indirizzo [www.dlinkgreen.com](http://www.dlinkgreen.com).

**NEDERLANDS****NL**

Dit symbool op het product of de verpakking betekent dat dit product volgens de plaatselijke wetgeving niet mag worden weggegooid met het huishoudelijk afval, maar voor recyclage moeten worden ingeleverd. Zodra het product het einde van de levensduur heeft bereikt, dient u het naar een inzamelpunt te brengen dat hiertoe werd aangeduid door uw plaatselijke autoriteiten, sommige autoriteiten accepteren producten zonder dat u hiervoor dient te betalen. Door het product en de verpakking op deze manier te recyclen helpt u het milieu en de gezondheid van de mens te beschermen.

**D-Link en het milieu**

Bij D-Link spannen we ons in om de impact van onze handelingen en producten op het milieu te beperken. Om deze impact te beperken, ontwerpt en bouwt D-Link zijn producten zo milieuvriendelijk mogelijk, door het gebruik van recycleerbare producten met lage toxiciteit in product en verpakking.

D-Link raadt aan om steeds uw D-Link producten uit te schakelen of uit de stekker te halen wanneer u ze niet gebruikt. Door dit te doen bespaart u energie en beperkt u de CO<sub>2</sub>-emissies.

Breng een bezoek aan [www.dlinkgreen.com](http://www.dlinkgreen.com) voor meer informatie over onze milieuverantwoorde producten en verpakkingen.

**POLSKI****PL**

Ten symbol umieszczony na produkcie lub opakowaniu oznacza, że zgodnie z miejscowym prawem i lokalnymi przepisami niniejszego produktu nie wolno wyrzucać jak odpady czy śmieci z gospodarstwa domowego, lecz należy go poddać procesowi recyklingu. Po zakończeniu użytkowania produktu, niektóre odpowiednie do tego celu podmioty przyjmą takie produkty nieodpłatnie, dlatego prosimy dostarczyć go do punktu zbiórki wskazanego przez lokalne władze. Poprzez proces recyklingu i dzięki takiemu postępowaniu z produktem oraz jego opakowaniem, pomogą Państwo chronić środowisko naturalne i dbać o ludzkie zdrowie.

**D-Link i środowisko**

D-Link podchodzimy w sposób świadomy do ochrony otoczenia oraz jesteśmy zaangażowani w zmniejszanie wpływu naszych działań i produktów na środowisko naturalne. W celu zminimalizowania takiego wpływu firma D-Link konstruuje i wytwarza swoje produkty w taki sposób, aby były one jak najbardziej przyjazne środowisku, stosując do tych celów materiały nadające się do powtórnego wykorzystania, charakteryzujące się małą toksycznością zarówno w przypadku samych produktów jak i opakowań.

Firma D-Link zaleca, aby Państwo zawsze prawidłowo wyłączali z użytku swoje produkty D-Link, gdy nie są one wykorzystywane. Postępując w ten sposób pozwalają Państwo oszczędzać energię i zmniejszać emisje CO<sub>2</sub>.

Aby dowiedzieć się więcej na temat produktów i opakowań mających wpływ na środowisko prosimy zapoznać się ze stroną Internetową [www.dlinkgreen.com](http://www.dlinkgreen.com).

**ČESKY****CZ**

Tento symbol na výrobku nebo jeho obalu znamená, že podle místně platných předpisů se výrobek nesmí vyhazovat do komunálního odpadu, ale odeslat k recyklaci. Až výrobek doslouží, odnešte jej prosím na sběrné místo určené místními úřady k tomuto účelu. Někteřá sběrná místa přijímají výrobky zdarma. Recyklací výrobku i obalu pomáháte chránit životní prostředí i lidské zdraví.

**D-Link a životní prostředí**

Ve společnosti D-Link jsme si vědomi vlivu našich provozů a výrobků na životní prostředí a snažíme se o minimalizaci těchto vlivů. Proto své výrobky navrhujeme a vyrábíme tak, aby byly co nejekologičtější, a ve výrobcích i obalech používáme recyklovatelné a nízkotoxické materiály.

Společnost D-Link doporučuje, abyste své výrobky značky D-Link vypnuli nebo vytáhli ze zásuvky vždy, když je nepoužíváte. Pomůžete tak šetřit energii a snížit emise CO<sub>2</sub>.

Více informací o našich ekologických výrobcích a obalech najdete na adrese [www.dlinkgreen.com](http://www.dlinkgreen.com).

**MAGYAR****HU**

Ez a szimbólum a terméken vagy a csomagoláson azt jelenti, hogy a helyi törvényeknek és szabályoknak megfelelően ez a termék nem semmisíthető meg a háztartási hulladékkal együtt, hanem újrahasznosításra kell küldeni. Kérjük, hogy a termék élettartamának elteltét követően vigye azt a helyi hatóság által kijelölt gyűjtőhelyre. A termékek egyes helyeken ingyen elhelyezhetők. A termék és a csomagolás újrahasznosításával segíti védeni a környezetet és az emberek egészségét.

**A D-Link és a környezet**

A D-Linknél megértjük és elkötelezettek vagyunk a műveleteink és termékeink környezetre gyakorolt hatásainak csökkentésére. Az ezen hatás csökkentése érdekében a D-Link a lehető leginkább környezetbarát termékeket tervez és gyárt azáltal, hogy újrahasznosítható, alacsony károsanyag-tartalmú termékeket gyárt és csomagolásokat alkalmaz.

A D-Link azt javasolja, hogy mindig kapcsolja ki vagy húzza ki a D-Link termékeket a tápforrásból, ha nem használja azokat. Ezzel segít az energia megtakarításában és a széndioxid kibocsátásának csökkentésében.

Környezetbarát termékeinkről és csomagolásainkról további információkat a [www.dlinkgreen.com](http://www.dlinkgreen.com) weboldalon tudhat meg.

**NORSK****NO**

Dette symbolet på produktet eller forpakningen betyr at dette produktet ifølge lokale lover og forskrifter ikke skal kastes sammen med husholdningsavfall, men leveres inn til gjenvinning. Vennligst ta det til et innsamlingssted anvist av lokale myndigheter når det er kommet til slutten av levetiden. Noen steder aksepteres produkter uten avgift. Ved på denne måten å gjenvinne produktet og forpakningen hjelper du å verne miljøet og beskytte folks helse.

**D-Link og miljøet**

Hos D-Link forstår vi oss på og er forpliktet til å minske innvirkningen som vår drift og våre produkter kan ha på miljøet. For å minimalisere denne innvirkningen designer og lager D-Link produkter som er så miljøvennlig som mulig, ved å bruke resirkulerbare, lav-toksiske materialer både i produktene og forpakningen.

D-Link anbefaler at du alltid slår av eller frakobler D-Link-produkter når de ikke er i bruk. Ved å gjøre dette hjelper du å spare energi og å redusere CO2-utslipp.

For mer informasjon angående våre miljøansvarlige produkter og forpakninger kan du gå til [www.dlinkgreen.com](http://www.dlinkgreen.com).

**DANSK****DK**

Dette symbol på produktet eller emballagen betyder, at dette produkt i henhold til lokale love og regler ikke må bortskaffes som husholdningsaffald, mens skal sendes til genbrug. Indlever produktet til et indsamlingssted som angivet af de lokale myndigheder, når det er nået til slutningen af dets levetid. I nogle tilfælde vil produktet blive modtaget gratis. Ved at indlevere produktet og dets emballage til genbrug på denne måde bidrager du til at beskytte miljøet og den menneskelige sundhed.

**D-Link og miljøet**

Hos D-Link forstår vi og bestræber os på at reducere enhver indvirkning, som vores aktiviteter og produkter kan have på miljøet. For at minimere denne indvirkning designer og producerer D-Link sine produkter, så de er så miljøvenlige som muligt, ved at bruge genanvendelige materialer med lavt giftighedsniveau i både produkter og emballage.

D-Link anbefaler, at du altid slukker eller frakobler dine D-Link-produkter, når de ikke er i brug. Ved at gøre det bidrager du til at spare energi og reducere CO<sub>2</sub>-udledningerne.

Du kan finde flere oplysninger om vores miljømæssigt ansvarlige produkter og emballage på [www.dlinkgreen.com](http://www.dlinkgreen.com).

**SUOMI****FI**

Tämä symboli tuotteen pakkauksessa tarkoittaa, että paikallisten lakien ja säännösten mukaisesti tätä tuotetta ei pidä hävittää yleisen kotitalousjätteen seassa vaan se tulee toimittaa kierrätettäväksi. Kun tuote on elinkaarensa päässä, toimita se lähimpään viranomaisten hyväksymään kierrätyspisteeseen. Kierrättämällä käytetyn tuotteen ja sen pakkauksen autat tukemaan sekä ympäristön että ihmisten terveyttä ja hyvinvointia.

**D-Link ja ympäristö**

D-Link ymmärtää ympäristönsuojelun tärkeyden ja on sitoutunut vähentämään tuotteistaan ja niiden valmistuksesta ympäristölle mahdollisesti aiheutuvia haittavaikutuksia. Nämä negatiiviset vaikutukset minimoidakseen D-Link suunnittelee ja valmistaa tuotteensa mahdollisimman ympäristöystävällisiksi käyttämällä kierrätettäviä, alhaisia pitoisuuksia haitallisia aineita sisältäviä materiaaleja sekä tuotteissaan että niiden pakkauksissa.

Suosittellemme, että irrotat D-Link-tuotteesi virtalähteestä tai sammutat ne aina, kun ne eivät ole käytössä. Toimimalla näin autat säästämään energiaa ja vähentämään hiilidioksiidipäästöjä.

Lue lisää ympäristöystävällisistä D-Link-tuotteista ja pakkauksistamme osoitteesta [www.dlinkgreen.com](http://www.dlinkgreen.com).

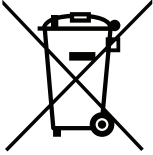
**SVENSKA****SE**

Den här symbolen på produkten eller förpackningen betyder att produkten enligt lokala lagar och föreskrifter inte skall kastas i hushållssoporna utan i stället återvinnas. Ta den vid slutet av dess livslängd till en av din lokala myndighet utsedd uppsamlingsplats, vissa accepterar produkter utan kostnad. Genom att på detta sätt återvinna produkten och förpackningen hjälper du till att bevara miljön och skydda människors hälsa.

**D-Link och miljön**

På D-Link förstår vi och är fast beslutna att minska den påverkan våra verksamheter och produkter kan ha på miljön. För att minska denna påverkan utformar och bygger D-Link sina produkter för att de ska vara så miljövänliga som möjligt, genom att använda återvinningsbara material med låg gifthalt i både produkter och förpackningar.

D-Link rekommenderar att du alltid stänger av eller kopplar ur dina D-Link produkter när du inte använder dem. Genom att göra detta hjälper du till att spara energi och minska utsläpp av koldioxid.

För mer information om våra miljöansvariga produkter och förpackningar [www.dlinkgreen.com](http://www.dlinkgreen.com).

**PORTUGUÊS****PT**

Este símbolo no produto ou embalagem significa que, de acordo com as leis e regulamentações locais, este produto não deverá ser eliminado juntamente com o lixo doméstico mas enviado para a reciclagem. Transporte-o para um ponto de recolha designado pelas suas autoridades locais quando este tiver atingido o fim da sua vida útil, alguns destes pontos aceitam produtos gratuitamente. Ao reciclar o produto e respectiva embalagem desta forma, ajuda a preservar o ambiente e protege a saúde humana.

**A D-Link e o ambiente**

Na D-Link compreendemos e comprometemo-nos com a redução do impacto que as nossas operações e produtos possam ter no ambiente. Para minimizar este impacto a D-Link concebe e constrói os seus produtos para que estes sejam o mais inofensivos para o ambiente possível, utilizando materiais recicláveis e não tóxicos tanto nos produtos como nas embalagens.

A D-Link recomenda que desligue os seus produtos D-Link quando estes não se encontrarem em utilização. Com esta acção ajudará a poupar energia e reduzir as emissões de CO<sub>2</sub>.

Para saber mais sobre os nossos produtos e embalagens responsáveis a nível ambiental visite [www.dlinkgreen.com](http://www.dlinkgreen.com).