

D-Link

xStack Storage™



D-Link xStack Storage iSCSI SAN Arrays

Managed SAN Solutions

DSN-3200 & DSN-3400

User's Guide

Version 2.0

© 2007 D-Link Networks, Inc. All Rights Reserved

D-Link Systems, Inc. makes no warranty of any kind with regard to this material, including, but not limited to, the implied warranties of merchantability and fitness for a particular purpose. D-Link Systems, Inc. shall not be liable for errors contained herein or for incidental or consequential damages in connection with the furnishing, performance, or use of this material.

This document contains proprietary information, which is protected by copyright. No part of this document may be photocopied, reproduced, or translated into another language without the prior written consent of D-Link Systems, Inc.

The information is provided "as is" without warranty of any kind and is subject to change without notice. The only warranties for D-Link products and services are set forth in the express warranty statements accompanying such products and services. Nothing herein should be construed as constituting an additional warranty. D-Link shall not be liable for technical or editorial errors or omissions contained herein.

Copyright © 2007 D-Link Systems, Inc.™

Trademarks

Adobe® and Acrobat® are trademarks of Adobe Systems, Incorporated.

Java™ is a U.S. trademark of Sun Microsystems, Incorporated.

Microsoft Windows is a U.S. registered trademark of Microsoft Corporation.

Oracle® is a registered U.S. trademark of Oracle Corporation, Redwood City, California.

UNIX® is a registered trademark of The Open Group.

All other brand or product names are or may be trademarks or service marks, and are used to identify products or services, of their respective owners.

D-Link Systems, Inc.
17595 Mount Herrmann Street
Fountain Valley, CA 92708

Safety Information



There is a danger of a new battery exploding if it is incorrectly installed. Replace the battery pack only with the same or equivalent type recommended by the manufacturer. Do not dispose of the battery along with household waste. Contact your local waste disposal agency for the address of the nearest battery deposit site.

This product also uses a lithium coin cell battery. The lithium coin cell battery is a long-life battery, and it is very possible that you will never need to replace it. However, should you need to replace it, consult your service documentation. Do not dispose of the battery along with household waste. Contact your local waste disposal agency for the address of the nearest battery deposit site.

Following are the safety agency certifications that the xStack Storage enclosure has met:

- CSA 60950-1
- UL 60950-1
- IEC 60950-1
- EN 60950-1

Compliance Information

- FCC Class A
- CE Class A
- C-Tick Class A
- VCCI Class A

Notice of Export Controls

Export of technical data contained in this document may require an export license from the United States government. Please contact D-Link Systems, Inc. for any export compliance questions.

Document Revision Level

Revision	Date	Notes
Version 1.0	August 10, 2006	
Version 1.1	March 7, 2007	Version 1.1, replaces Version 1.0 - Revises drive numbering schema to reflect proper drive numbers 0 through 14 instead of 1 through 15.
Version 2.0	September 20, 2007	Version 2.0, replaces Version 1.1 - Revisions include product functionality, diagnostics, out-of-box-experience (OOBE).

Preface

This User's Guide assumes that the user is computer literate and is familiar with Storage Array Products, has a basic understanding of storage products and concepts, and understands the Host Operating Software supported by this product

Typographic Conventions

Notes

Notes provide information that deserves special attention. They are preceded by:



Cautions

Cautions contain information which, if not followed, can cause damage to the xStack Storage unit. They are preceded by:



Warnings

Warnings contain information which, if not followed, can cause damage to the xStack Storage unit and to the person installing it. They are preceded by:



Contact Information

You can find software updates and user documentation on the D-Link website.

D-Link provides free technical support for customers within the United States and within Canada for the duration of the warranty period on this product.

U.S. and Canadian customers can contact D-Link Technical Support through our website, or by phone.

Tech Support for customers within the United States:

D-Link Technical Support over the Telephone

Please see our support site for current number:

- <http://support.dlink.com>
- Monday to Friday 8:00am - 5:00pm PST/PDT

D-Link Technical Support over the Internet:

- <http://support.dlink.com>

Tech Support for customers within Canada:

D-Link Technical Support over the Telephone

Please see our support site for current number:

- <http://support.dlink.ca>
- Monday to Friday 7:30am to 9:00pm EST/EDT

D-Link Technical Support over the Internet:

- <http://support.dlink.ca>

Contents

Chapter 1	Introduction	11
1.1	Models	12
1.2	Benefits and Features	13
1.3	System Overview	14
Chapter 2	Identifying Hardware Components.....	15
2.1	Front Panel Components	15
2.1.1	LEDs	16
2.1.2	Key Lock and Latches.....	16
2.1.3	Drive Bays	17
2.1.4	Front Vents.....	21
2.2	Back Panel Components	21
2.2.1	Switches	22
2.2.2	External Interfaces.....	23
2.2.3	Rear Vents	26
Chapter 3	Installing the xStack Storage Array.....	27
3.1	Site Considerations.....	27
3.2	Safety Considerations.....	28
3.3	Unpacking the xStack Storage Array	28
3.4	Items Supplied by the User	29
3.5	Installing the xStack Storage Array without a Rack	30
3.6	Installing the xStack Storage Array in a Rack.....	30
3.7	Connecting to the xStack Storage DSN-3200 Host Network Connection Ports	31
3.8	Connecting to the xStack Storage DSN-3400 Host Network Connection Port	31
3.9	Connecting to the xStack Storage Management Port.....	32
3.10	Connecting the Battery Pack	33
3.11	Connecting the Power Cords	34
3.12	Booting the xStack Storage Array.....	35
Chapter 4	Starting the xStack Storage Array for the First Time.....	37
4.1	Initial Startup and Welcome	37
4.2	Entering Initial Management Port Settings.....	38
4.3	Entering Administrator Account Password	39
4.4	Entering the System Date and Time.....	40
4.5	Setting Up Email Notifications	41
4.6	Completing the OOBE Setup Wizard.....	42
Chapter 5	Configuring the xStack Storage Array	45
5.1	Launching the xStack Storage Management Console	46
5.2	Understanding the Main Screen	49
5.2.1	Menu / Tool Bar Area.....	50
5.2.2	Resources Pane	51

5.2.3	Main Display Area	53
5.2.4	Footer	54
5.3	Managing User Accounts.....	55
5.3.1	Setting Up User Accounts	55
5.3.2	Deleting User Accounts.....	57
5.4	Managing the xStack Storage Array.....	57
5.4.1	Working with Volumes.....	57
5.4.2	Adding iSCSI Initiators	68
5.4.3	Working with LAGs and VLANs	69
5.4.4	Working with Network Portals	75
5.4.5	Creating iSCSI Target Nodes.....	77
5.4.6	Logging on from the iSCSI Initiator Computer.....	83
5.4.7	Changing the iSCSI Port Number.....	83
5.4.8	Setting the Default Task Priority	84
5.4.9	Adding, Viewing, and Deleting IP Route Tables.....	85
5.4.10	Modifying System TCP/IP Settings.....	87
5.4.11	Setting the Spare Count.....	88
5.4.12	Using the Down Drive Feature	89
5.4.13	Using the xStack Storage Array's iSNS Features	90
5.4.14	Creating Scheduled Tasks.....	92
5.4.15	Setting the System Battery Policy.....	94
5.4.16	Saving the Event Log.....	95
5.5	Changing Initial Configuration Settings.....	96
5.5.1	Changing the Out-of-Band Port Configuration	96
5.5.2	Changing the System Date and Time	97
5.5.3	Changing Email Notification Setup	98
5.6	Managing xStack Storage Array Configurations.....	99
5.6.1	Saving the xStack Storage Array Configuration	99
5.6.2	Restoring the xStack Storage Array Configuration	100
5.6.3	Restoring Factory Defaults	101
5.7	Restarting the xStack Storage Array	101
5.8	Shutting Down the Management Console.....	102
5.9	Shutting Down the xStack Storage Array	102

Chapter 6 Monitoring the xStack Storage.....104

6.1	Viewing Enclosure Information.....	105
6.2	Viewing Log Messages.....	106
6.3	Viewing, Modifying, and Deleting xStack Storage Array Tasks	108
6.4	Viewing Server SMI Information.....	109
6.5	Viewing Firmware Image Information.....	110
6.6	Viewing Storage Pool Information	111
6.7	Viewing Storage Pool Tasks.....	112
6.8	Viewing Volume Information	113
6.9	Viewing Volume Tasks	114
6.10	Viewing Information about Drives in the Blade A Base Pool	115
6.10.1	Viewing Information About Physical Drives.....	115
6.10.2	Viewing SMART Information for a Drive	116
6.11	Viewing Target Node Information	118
6.12	Viewing Volume Access Information	119
6.13	Viewing Initiator Access Information.....	120

6.14	Viewing LAG Port Information.....	121
6.15	Viewing Network Portal Information.....	122
6.16	Viewing Connection Information.....	123
6.17	Viewing iSCSI Initiator Information.....	124
6.18	Viewing LUN Map Information.....	125
6.19	Viewing Ethernet Port Information.....	126
Chapter 7	Performing Diagnostics.....	127
7.1	Pinging from an xStack Storage Array Network Portal.....	127
7.2	Pinging from the xStack Storage Array Management Port.....	128
Appendix A	Factory Default Settings.....	129
Appendix B	Recording Your Configuration Settings.....	131
B.1	Recording Out-of-Box Settings.....	131
B.2	Recording Volumes.....	132
B.3	Recording iSCSI Initiators.....	133
B.4	Recording LAGs.....	134
B.5	Recording Network Portals.....	135
B.6	Recording iSCSI Target Nodes.....	136
B.7	Recording IP Routing Tables.....	137
B.8	Recording Scheduled Tasks.....	138
Appendix C	Performing Advanced Diagnostics.....	139
C.1	Accessing the Serial Port Diagnostic Menu.....	139
C.2	Accessing the Management Port Diagnostic Menu.....	140
Appendix D	Replacing and Upgrading FRUs.....	146
D.1	Installing the Battery Pack.....	146
D.2	Installing Memory.....	149
D.3	Installing or Replacing SATA Drives.....	151
Appendix E	Upgrading Firmware.....	161
Appendix F	Hardware Enclosures.....	163
F.1	Front View.....	163
F.2	Back View.....	163
Appendix G	Acronyms and Abbreviations.....	165

Chapter 1 Introduction

The xStack Storage Array is an intelligent, high-performance iSCSI Gigabit Ethernet storage solution designed for businesses that want to improve the reliability, availability, serviceability, and performance of their storage systems.

Based on an Internet Protocol-Storage Area Network (IP-SAN) architecture, the xStack Storage controller is built around a custom-designed Application Specific Integrated Circuit (ASIC) solution combining 10Gbps iSCSI, TCP/IP offload, embedded processors and a storage virtualization firmware stack controlled by firmware loaded into the on-board flash memory. The controller is housed in a 19-inch 3U rugged hardware enclosure holding up to 15 internal Serial ATA (SATA) drives, up to 512MB of system memory and up to 4GB of cache buffer memory. Host connectors for each model are as follows:

- DSN-3200 provides eight 1GbE RJ-45 host connectors accessed via the back panel
- DSN-3400 provides a single 10GbE XFP-transceiver interface (transceiver sold separately) accessed via the back panel.

The xStack Storage Array's back panel also has a 10/100 Mbps management port and an RS-232-C DB9 diagnostic/console port.

Complete configuration and management are available through the intuitive, GUI-based Web Manager interface. A variety of network configurations are easily established using the xStack Storage Array's volume management, initiator, target, network portal, and Link Aggregation Group (LAG) features. In addition, the xStack Storage Array features Secure Sockets Layer (SSL), default task priority, cache, TCP/IP, spare count, and battery policy settings for advanced users.

1.1 Models

The xStack Storage DSN-3000 series is available in a standard 19-inch 3U rack-mount chassis with 15 hot-swappable drive bays. The models vary according to the number, speed, and type of host network connections.

Table 1-1 xStack Storage Array Models

Model	Description
DSN-3200	Maximum number of host network iSCSI connections: Eight RJ-45 ports Speed: 1 Gigabit Ethernet (1 GbE) Maximum number of internal SATA drives: 15 Maximum amount of system memory: 512MB Maximum amount of cache buffer memory: 4GB
DSN-3400	Maximum number of host network iSCSI connections: One XFP transceiver host network connection Speed: 10 GbE Maximum number of internal SATA drives: 15 Maximum amount of system memory: 512MB Maximum amount of cache buffer memory: 4GB

1.2 Benefits and Features

- High-performance, low-latency iSCSI storage system, with a highly integrated, reliable, multifunction ASIC for fully featured, integrated storage virtualization.
- Modular design with up to 15 SATA disk drives.
- 1 GbE and 10 GbE models provide an easy transition to faster Ethernet connectivity.
- Eight copper 1Gb (802.3ab) Ethernet network ports on the DSN-3200
- One XFP 10Gb Ethernet port on the DSN-3400. (XFP transceiver sold separately)
- One DB9 RS-232-C diagnostic port
- Easy setup and configuration - can be placed anywhere on a 10BaseT, 100BaseT, or Gigabit Ethernet network for improved access to critical information.
- Out-of-band management via a direct connection or the Web. Communication via the management port is encrypted using SSL, without requiring configuration by the user.
- Delivers Ethernet economics to storage for lower total cost of ownership and rapid deployment using known and trusted technologies.
- Proven transport infrastructure for increased reliability, investment protection, and reduced training costs.
- Scalability over long distances - ideal for remote data replication and disaster recovery.
- One 760W 3U n+1 auto-switching universal power supply for high availability
- Three hot-swappable cooling fans
- Supports Self-Monitoring Analysis and Reporting Technology (S.M.A.R.T.), a technology designed to monitor the reliability of hard drives.
- Battery pack preserves the contents of the buffer cache in the event of a power failure (contents will be backed up for approximately 72 hours)

1.3 System Overview

Figure 1-1 shows a typical Storage Area Network (SAN) configuration in which xStack Storage Array can be used. The Storage Area Network portion of this diagram is a private high-speed Ethernet network that is dedicated to the exchange of data between the network servers and the xStack Storage Array. The high bandwidth used by the servers exchanging data with the xStack Storage Array can easily consume high bandwidth on the LAN (Local Area Network) where users PCs are attached. Creating a separate network to isolate this traffic avoids bogging down the customer's existing LAN and helps improve security.

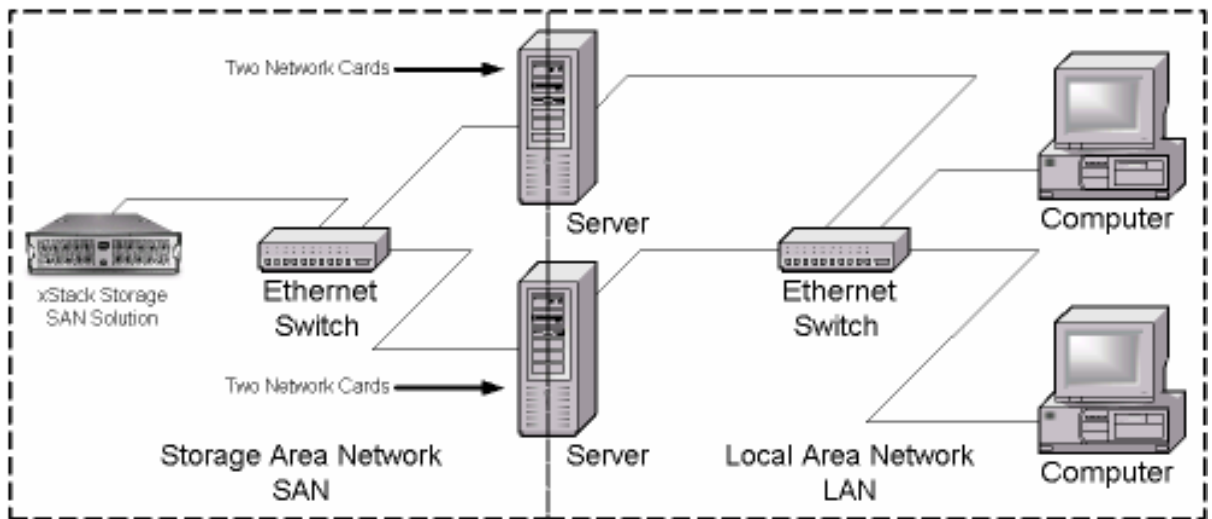

Figure 1-1 xStack Storage Array System Diagram

Chapter 2 Identifying Hardware Components

This chapter describes the xStack Storage Array’s hardware components.

2.1 Front Panel Components

The following sections describe the hardware components on the front of the xStack Storage Array enclosure. Figure 2-1 shows the removable front bezel along with the drive bays and major components.

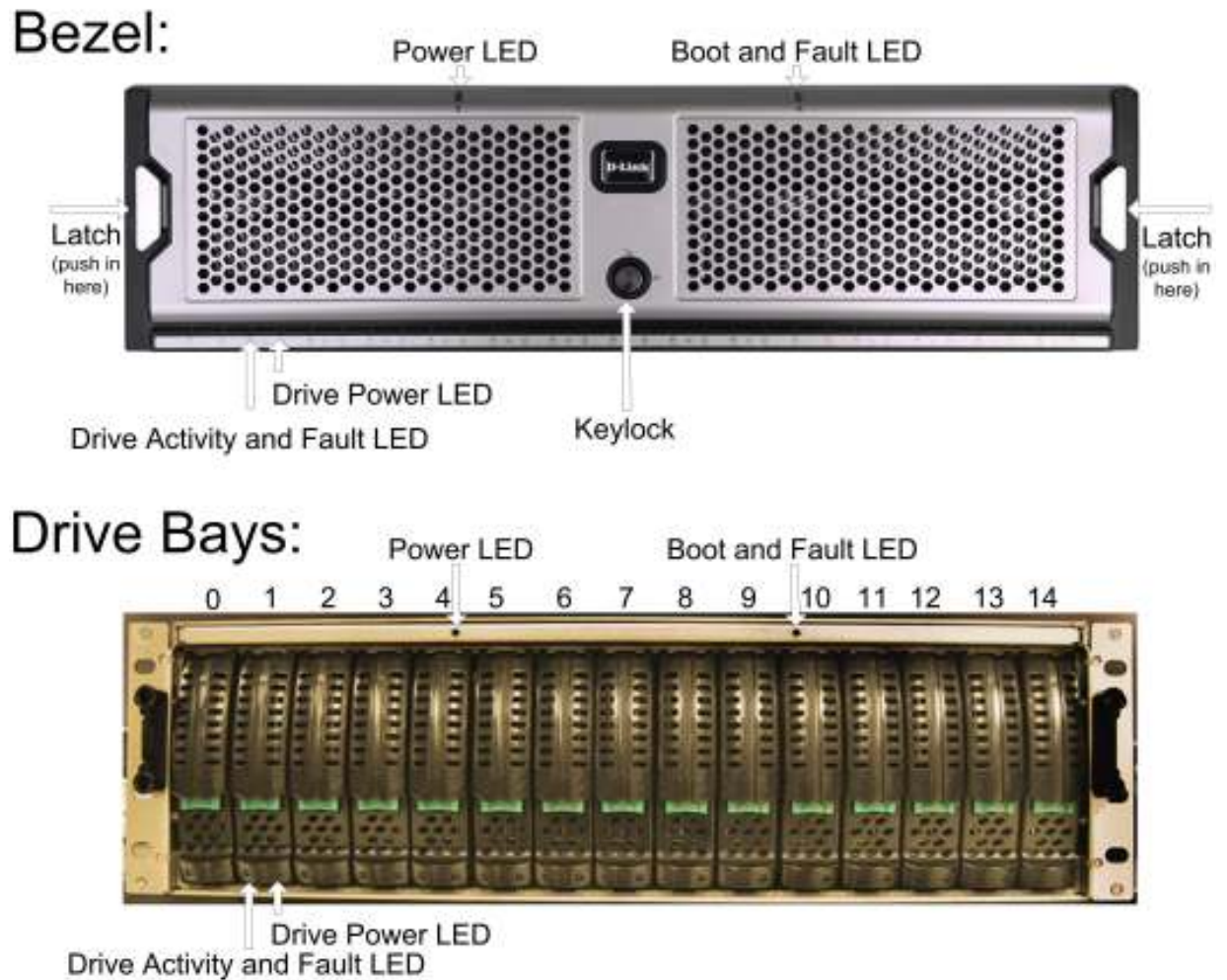

Figure 2-1 Front View of the xStack DSN-3000 Series Enclosure



When installed, the front bezel uses pipes to pass light from the LEDs behind it to the front for viewing. The bezel itself is passive and has no active LEDs.

2.1.1 LEDs

Figure 2-1 reveals several LEDs that provide useful information about the state of the xStack Storage Array. The Power LED illuminates when the system is powered. The bicolor Boot and Fault LED will remain clear during bootup and then green if booting is successful. If the boot process is unsuccessful, or a system fault occurs, then it will turn red.

Each of the fifteen drive bays has two LEDs associated with it, a bicolor drive activity and fault LED and a drive power LED. Table 2-1 describes the front panel LEDs and their functions.

Table 2-1 Front Panel LED indicators on the DSN-3000 series enclosure

LED	Color	Meaning
Power	Green ON	Power is applied to the system
Boot and Fault	Green ON	Successful boot. No errors encountered.
	Red ON	Remains clear during boot process. If red after boot process completed, then an error has been encountered. Please see management GUI for more information.
Drive Power	Blue ON	Drive is powered and operational.
Drive Activity and Fault	Green Blinking	Data being transmitted or received from corresponding SATA drive.
	Red ON	Drive has experienced a fault and is offline

2.1.2 Key Lock and Latches

Figure 2-1 shows the xStack Storage Array's front bezel with key lock and two latches. This bezel can be locked in place to protect the system from unauthorized drive access and removal.

Bezel Removal: Simply press inwards (as the arrows reveal) on the two latches shown in Figure 2-1. The bezel will come off easily providing access to the drive bays behind it. If the key lock is in the locked position, then the latches cannot be pressed inwards.

Bezel Installation: Align the bezel in front of the chassis and push forward. The latches are spring-loaded and will lock into place. If you wish, you can use the key lock to prevent drive access by turning it to the locked position.

2.1.3 Drive Bays

Figure 2-1 illustrates the fifteen hot-swappable drive bays and their numbering scheme from left to right (0 through 14).

2.1.3.1 Drive and Tray Removal

A drive/tray assembly can be removed by pressing upwards on the green latch found on the tray and removing it with the handle as shown in Figure 2-2 and Figure 2-3.



Figure 2-2 Drive and Tray Removal



Figure 2-3 Remove Drive/Tray



Removal of a populated drive/tray assembly can have unforeseen effects including the loss of all data in a volume. A drive can be part of a volume that may or may not be redundant. Before removing a drive from an operating xStack Storage Array, make sure it is the correct one.

2.1.3.2 Drive and Tray Installation

A drive/tray assembly can be installed by inserting the drive/tray assembly into the open drive bay as shown in Figure 2-4. Push the tray at the point indicated in Step 2 of Figure 2-5 and push until it is seated firmly within the bay. As you press, you will see the tray handle begin to move inwards as the locking mechanism enters the locking slot. When you see this, then you must push the tray handle inwards as shown in Figure 2-6 until you hear the green locking mechanism click.



Figure 2-4 Drive/Tray Installation



Figure 2-5 Press Here Until You See the Lever Move Inwards



Figure 2-6 Press Lever Inwards Until it Locks

2.1.4 Front Vents

The enclosure that houses the xStack Storage Array contains a set of three hot-swappable fans located in the mid-section of the chassis drawing air into vents in the front of the unit, cooling the hard drive array and other components. This air exits the chassis through a grill located at the rear of the chassis. It is advised that the unit only be operated with the top cover in place. When installing the xStack Storage Array, please be sure these vents are not blocked.



A fully loaded array with all drive bays filled can generate a significant amount of heat. Please be sure the cover is in place to provide the forced air flow required for proper cooling.

2.2 Back Panel Components

The following sections describe the hardware components on the rear of the xStack Storage Array's enclosure. Figure 2-7 shows the major components.

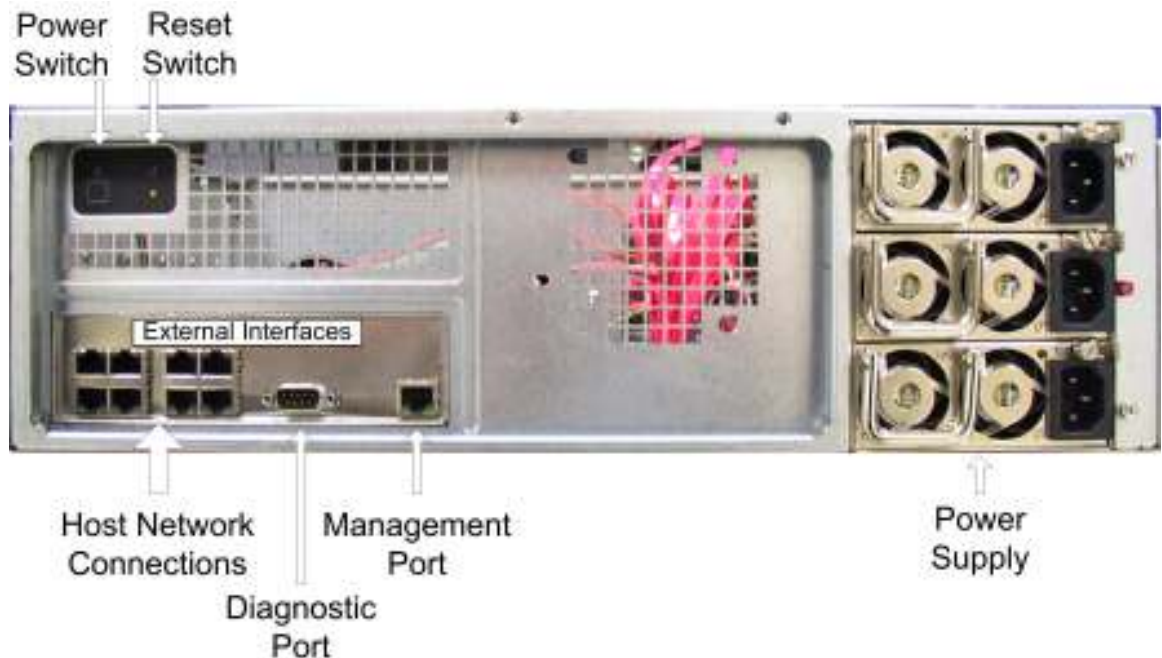

Figure 2-7 Rear View of the xStack Storage DSN-3200 Enclosure

2.2.1 Switches

The rear panel of the xStack Storage unit enclosure has two switches as shown in Figure 2-8. Table 2-2 identifies the switches and their function.

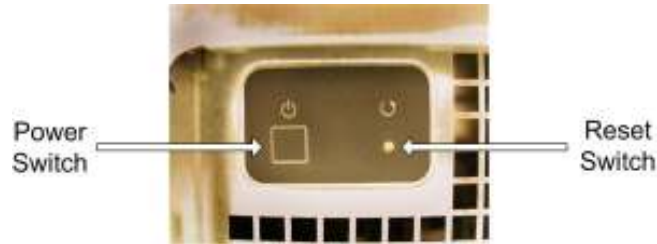

Figure 2-8 Power and Reset Switches

Table 2-2 Power and Reset Switches Function

Switch	Description
Power	Applies power to the xStack Storage Array. Pressing this switch for longer than 3 seconds removes power from the xStack Storage Array and turns off the unit.
Reset	Resets the xStack Storage Array.

2.2.2 External Interfaces

Figure 2-7 shows an area labeled “External Interfaces” where the external ports of the DSN-3000 Series are found.

2.2.2.1 DSN-3200 External Interfaces

The back of the xStack Storage DSN-3200 enclosure provide the following external interfaces:

- Eight (8) 1GbE (1 Gigabit Ethernet) RJ-45 host network connections
- One DB9 RS-232-C diagnostic port
- One RJ-45 Fast Ethernet management port

Figure 2-9 shows the hardware components on the back of the xStack Storage DSN-3200 enclosure

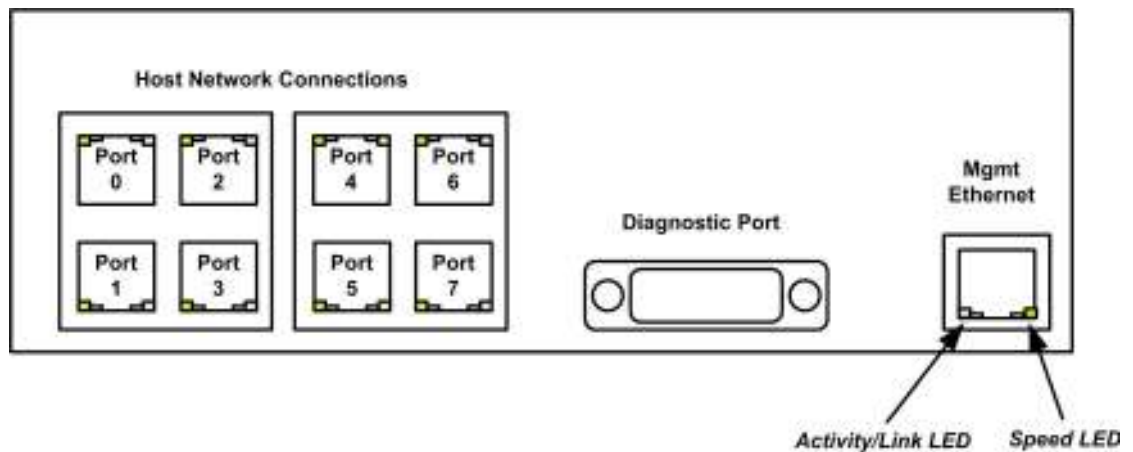

Figure 2-9 External Interfaces on the xStack Storage DSN-3200 Enclosure

2.2.2.2 DSN-3200 LEDs

Each RJ-45 host network connection on the back of the xStack Storage DSN-3200 enclosure has two bicolor light-emitting diode (LED) indicators that show the activity and speed for that port. Table 2-3 describes the host network connection LED indicators on the back of the xStack Storage DSN-3200 enclosure.

Table 2-3 Host Network Connection LED Indicators on the xStack DSN-3200 Enclosure

LED	Color	Description
RJ-45 Port Activity	Green	Data is being transmitted on the RJ-45 port.
	Yellow	Data is being received on the RJ-45 port.
RJ-45 Port Speed	OFF	Data is being sent or received at 10 Mbps.
	Green	Data is being sent or received at 100 Mbps.
	Yellow	Data is being sent or received at 1 Gbps.

In addition, the management port has two bicolor LED indicators that show the activity/link and speed for this port. Table 2-4 describes the management port LEDs and Figure 2-9 shows their location.

Table 2-4 Management Port LED Indicators on the xStack Storage DSN-3200 Enclosure

LED	Color	Meaning
Activity/Link	Green ON	Link is operational.
	Green Blinking	Data is being transmitted or received on the RJ-45 port.
	Yellow OFF	Connection has been established at 10 Mbps.
	Yellow ON	Connection has been established at 100 Mbps.
Port Speed	OFF	Data is being sent or received at 10 Mbps.
	Yellow	Data is being sent or received at 100 Mbps.

2.2.2.3 DSN-3400 External Interfaces

The back of the xStack DSN-3400 enclosure provides the following external interfaces:

- A single 10 GbE XFP transceiver host network connection
 - (optical or copper depending on what interface you install)
- One DB9 RS-232-C diagnostic port
- One RJ-45 Fast Ethernet management port

Figure 2-10 shows the hardware components on the back of the xStack DSN-3400.

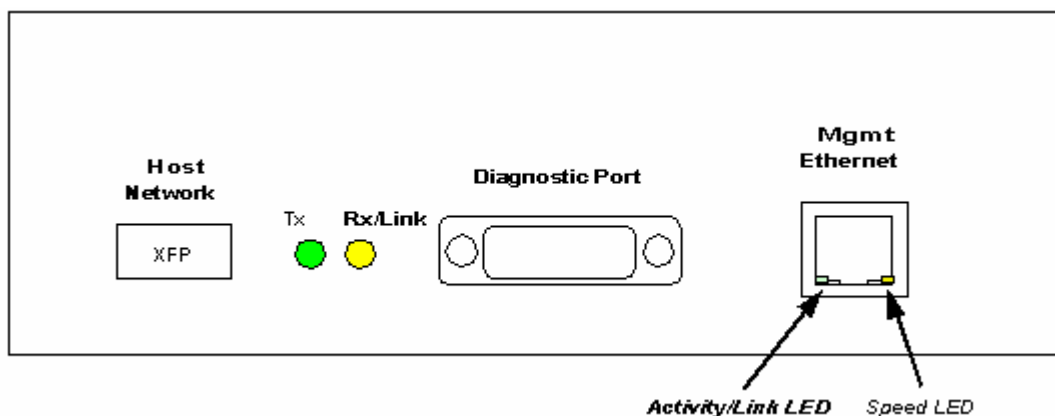

Figure 2-10 External Interfaces on the xStack DSN-3400 Enclosure

2.2.2.4 DSN-3400 LEDs

Two LEDs next to the XFP connector show transmit (Tx) and receive (Rx) activity on the host network interface. Table 2-5 describes the Tx and Rx LED indicators on the back of the xStack DSN-3400 enclosure.

Table 2-5 Host Network Connection LED Indicators on the xStack DSN-3400 Enclosure

LED	Color	Description
Tx Link	OFF	There is no transmit activity.
	Blinks Green	There is transmit activity from the xStack DSN-3400.
Rx Link	OFF	There is no receive activity.
	Solid Yellow	A 10GbE connection has been established.
	Blinks Yellow	There is receive activity with the xStack DSN-3400.

In addition, the management port has two bicolor LED indicators that show the activity/link and speed for this port. Table 2-6 describes the management port LEDs and Figure 2-10 shows their location.

Table 2-6 Management Port LED Indicators on the xStack DSN-3400 Enclosure

LED	Color	Meaning
Activity/Link	Green ON	Link is operational.
	Green Blinking	Data is being transmitted or received on the RJ-45 port.
	Yellow OFF	Connection has been established at 10 Mbps.
	Yellow ON	Connection has been established at 100 Mbps.
Port Speed	OFF	Data is being sent or received at 10 Mbps.
	Yellow	Data is being sent or received at 100 Mbps.

2.2.3 Rear Vents

Figure 2-7 shows air vents that allow the exit of air through the rear of the chassis. Please be sure these vents are not blocked.

Chapter 3 Installing the xStack Storage Array

This chapter describes how to install the xStack Storage Array.

3.1 Site Considerations

The site where you install the xStack Storage Array can affect its performance, Please observe the following guidelines when setting up the xStack Storage Array.

- Install the xStack Storage Array on a sturdy, level surface that can support the unit. A fully populated xStack Storage unit weighs approximately 75 lbs. (33 kg.).
- The power outlet should be within six feet (1.82 meters) of the xStack Storage Array.
- For the xStack Storage Array to perform at optimal levels there must be adequate heat dissipation and ventilation around the unit to avoid overheating.
 - Leave at least six inches (152.3 mm) of space at the front and back of the xStack Storage Array for ventilation.
 - Do not locate the xStack Storage Array next to, on top off, or below any device that generates a significant amount of heat or will block the fee flow of air through the ventilation slots on the xStack Storage Array.
- Install the xStack Storage Array in a fairly cool and dry location for the acceptable temperature and humidity ranges.
- Install the xStack Storage Array in a site free from strong electromagnetic field generators (such as motors), vibration, dust, and direct exposure to sunlight.

For rack installation, the following additional considerations must be observed:

- The xStack Storage Array can be mounted in a standard 19-inch rack. The rack-mounting hardware must be carefully selected to properly support the equipment. Follow the instructions in the documentation for the rack.
- The operating ambient temperature of rack-mounted equipment must not exceed the maximum rated ambient temperature of 104 degrees F (70 degrees C).
- The air flow clearances specified in this guide must be maintained within the rack.
- The AC supply circuit for rack-mounted equipment must be capable of supplying the total current specified on all the labels of the rack-mounted equipment.
- All AC power supply connections must be properly earthed. To ensure the integrity of the earth connection, special attention must be given to connections that are not directly connected to the branch circuit (for example, power strips).

3.2 Safety Considerations

Observe the following guidelines to ensure safety:

- Do not wear loose clothing that could get caught in the chassis mounting hardware.
- Wear safety glasses when working under conditions that are hazardous to your eyes.
- Do not perform any action that creates a potential hazard to people or makes the rack or equipment unsafe.
- Do not work on the equipment or disconnect cables during a thunderstorm, when wearing a wool sweater or other heavy wool clothing, or when power is applied.
- Disconnect all power before installation and before connecting or disconnecting cables.
- Avoid hazards such as moist floor and ungrounded power-extension cables.
- To avoid damage to the xStack Storage Array due to Electrostatic discharge (ESD), wear an ESD-preventive wrist strap. If no wrist strap is available, ground yourself by touching the metal part of the chassis. Connect the clip to an unpainted surface of the chassis frame to safely channel unwanted ESD voltages to ground.

3.3 Unpacking the xStack Storage Array

After receiving the xStack Storage Array, perform the following steps to ensure that it and other contents arrived safely.

To unpack the xStack Storage Array:

1. Inspect the outer shipping container for any damage that may have occurred in shipping. Report any sign of damage to the appropriate shipping agency.
2. Remove the xStack Storage Array and cables from the shipping container.
3. Save the shipping container, foam, and antistatic bags in case you have to return the xStack Storage Array. Returning the xStack Storage unit in any other container is not advised.
4. Be sure the following parts are included:
 - xStack Storage Array
 - Three power cords
 - Console cable (straight-through female DB9 to female DB9)
 - Rackmount rail kit
 - CD including this User Guide
5. Inspect the xStack Storage Array thoroughly. If you see any signs of damage, notify a sales representative and/or the shipping agency.

3.4 Items Supplied by the User

Table 3-1 lists the additional items that you must supply to perform the xStack Storage Array installation. All users must provide the items in the first row of Table 3-1. Thereafter, the additional items required for installation depend on the user category into which you fit.

Table 3-1 User-Supplied Items to Perform the xStack Storage Installation

User Category	User-Supplied Items
All xStack Storage Users	<ul style="list-style-type: none"> ▪ One or more computers with Network Interface Cards (NICs) that will act as the iSCSI initiator(s). This is typically the user's server(s). Each iSCSI initiator must be given an iSCSI initiator node name. (See Note 1) ▪ A PC with a NIC, a fixed IP address, and Internet access that will act as the management console. (See Note 1) ▪ One or more available AC outlets not controlled by a wall switch. ▪ <i>Optional:</i> An Ethernet switch and Ethernet cable. If you want to use the xStack Storage Array's Link Aggregation feature, the switch must support LAGs.
xStack DSN-3200 Users	<ul style="list-style-type: none"> ▪ A static IP address for each xStack Storage host connection RJ-45 data port that will connect to your SAN. ▪ An Ethernet cable for each xStack Storage host connection RJ-45 data port that will connect to your SAN (the xStack Storage auto-senses the cable type used).
xStack DSN-3400 Users	<ul style="list-style-type: none"> ▪ A static IP address for the host network connection. ▪ Either a single mode or multimode XFP optical cable or a copper Ethernet cable, and the appropriate XFP module to connect the host network connection to your SAN.
Rack-Mount Users	<ul style="list-style-type: none"> ▪ A standard NEMA-compliant 19-inch rack. ▪ Mounting hardware.
<p>Note 1: For convenience, one PC with three installed NICs can be used instead of separate PCs. In this configuration, one NIC connects to the xStack Storage management port, a second NIC connects to the Internet, and a third NIC is used with the iSCSI initiator.</p>	

3.5 Installing the xStack Storage Array without a Rack

When installing the xStack Storage Array on a desktop or shelf, allow enough ventilation space between the xStack Storage unit and any other objects in the vicinity. In particular, be sure not to block the air vents on the front and back of the xStack Storage Array enclosure. Install the cables and power cord according to the procedures in the following sections.

3.6 Installing the xStack Storage Array in a Rack

The xStack Storage Array can be mounted in a standard 19-inch rack. Use the following procedure, along with the documentation for the rack, to install the xStack Storage unit in a rack.



The rack cabinet must provide sufficient airflow to the front and back of the xStack Storage unit to maintain correct cooling. It must include ventilation sufficient to exhaust the heat generated by equipment installed in the rack.

1. Be sure the xStack Storage Array is turned off and its three power cords are not attached to the unit.
2. Attach the mounting hardware to the left and right sides of the xStack Storage Array. Refer to the documentation for your mounting hardware and rack.
3. With the assistance of another person, hold the xStack Storage unit in place in the rack and secure with the mounting hardware. Refer to the documentation for your mounting hardware and rack.
4. Install the cables and power cords according to the procedures in the following sections.

3.7 Connecting to the xStack Storage DSN-3200 Host Network Connection Ports

The DSN-3200 host network connections consist of eight RJ-45 data ports. These ports connect to your SAN using either a straight-through or cross-over RJ-45 Ethernet cable (the xStack Storage Array auto-senses the type of cable used). You will need one cable for each RJ-45 data port you want to connect to your SAN.

To connect the DSN-3200 RJ-45 host network connections to your SAN, use the following procedure:

1. Attach either end of an Ethernet cable to host network connection port 0 on the xStack Storage unit's back panel
2. To connect additional DSN-3200 RJ-45 host network connections to your SAN, repeat step 1 using another Ethernet cable and the next available xStack Storage port in sequence (port 1, then port 2, and so on). Do not skip ports when making these connections.

3.8 Connecting to the xStack Storage DSN-3400 Host Network Connection Port

The DSN-3400 host network connection consists of a single 10 GbE host network XFP transceiver interface. The XFP module can consist of either optical or copper connectivity depending on the XFP module you install. An optical solution connects to your SAN using a single mode or multimode XFP optical cable. A copper solution attaches to your SAN with a special CX4 cable. (XFP transceiver sold separately)

To connect the DSN-3400 host network connection port to your SAN, use the following procedure.

1. If an optical XFP module has been installed, then connect one end of a single mode or multimode optical cable to the xStack Storage optical host network connection port. If a copper CX4 XFP module has been installed, then connect one end of a copper CX4 cable to your xStack Storage host network connection port.
2. Connect the other end of the cable to your SAN.

3.9 Connecting to the xStack Storage Management Port

Connecting a PC to the xStack Storage management port lets you configure and manage the xStack Storage Array. This procedure requires a PC with an installed NIC and an appropriately configured Ethernet cable.

- To connect the PC directly to the xStack Storage management port, use a cross-over cable.
- To connect the PC to the xStack Storage Array using a hub or switch, use a straight-through cable.

To connect to the xStack Storage management port, use the following procedure.

1. Connect either end of an Ethernet cable to a NIC installed in the PC that will be used to manage and monitor the xStack Storage unit.
2. Connect the other end of the cable into the xStack Storage **Mgmt Ethernet** port. Facing the back of the xStack Storage unit, the management port is the rightmost RJ-45 connector:
 - To view this port on the xStack DSN-3200, see Figure 2-9 on page 23.
 - To view this port on the xStack DSN-3400, see **Error! Reference source not found.** on page 25.



If you want to configure the xStack Storage Array for email alert notifications, be sure the management port can communicate via Ethernet with your mail server.



xStack Storage management and data activities must be separate. This means you cannot connect the same NIC to the management and host network connection ports. Rather, one NIC must connect to the management port and a different NIC, either in the same PC or a different PC, must connect to the host network connection port(s).

3.10 Connecting the Battery Pack

The xStack Storage Array comes equipped with a battery pack to provide back up of the buffer cache contents (See Figure 3-1). Since write-back caching is always enabled on the xStack Storage Array, we recommend you have a battery installed at all times. The battery is attached to the controller board through a 3-pin connector at J-35.

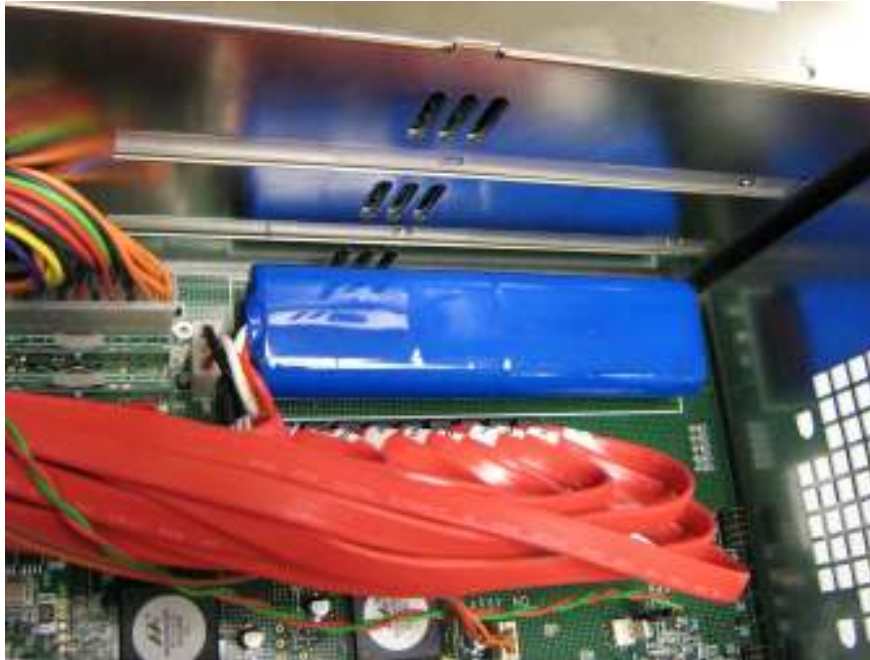

Figure 3-1 Battery Pack Installed on xStack Controller

3.11 Connecting the Power Cords

The receptacles for connecting the xStack Storage Array's three power cords appears on the back of the unit as seen in Figure 3-2. To connect a power cord for each of the power supplies three redundant power modules, use the following procedure.

1. Plug the female end of the power cord into one of the three 3-pronged power connectors on the back of the xStack Storage unit.
2. Plug the other end of the power cord into a working AC outlet that is not controlled by a wall outlet.
3. Repeat steps 1 and 2 for the remaining two power cords.



Figure 3-2 Power Supply

3.12 Booting the xStack Storage Array

To power on the xStack Storage Array, press the power switch on the rear panel as seen in Figure 3-3. When the xStack Storage unit powers on, the following actions occur:

- The front panel Power LED goes ON.
- The xStack Storage unit runs its startup process, which takes from 4 to 5 minutes to complete.
- The front panel Link Status LEDs for the SATA drive LEDs may flash.
- When the Boot and Fault Ready LED turns green the xStack Storage unit is ready for use.

When power is applied to the xStack Storage Array for the first time with a Web browser attached to the unit's management port, the "Out-of-Box Experience" (OOBE) setup wizard is launched, allowing you to specify initial settings. Thereafter, each subsequent time you start the xStack Storage Array, the unit uses the initial settings along with its factory-default configuration settings. If necessary, you can use the xStack Storage Web Manager Interface to change the initial and factory-default settings to suit your requirements.

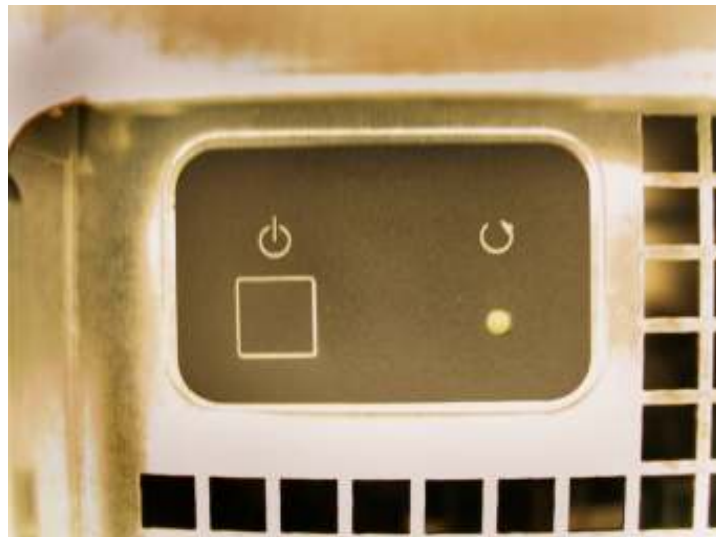

Figure 3-3 Power-On Switch and Reset Switch Located on Rear of Enclosure

Chapter 4 Starting the xStack Storage Array for the First Time

The xStack Storage Array is designed with simplicity and ease-of-use in mind for new users. Towards that end, the xStack Storage Array comes with an "Out-Of-Box Experience" (OOBE) setup wizard that lets you expedite the unit's configuration. After the OOBE setup wizard is completed, the xStack Storage Array boots up using the settings you configured in the OOBE setup wizard. Thereafter, you can use the procedures in Chapter 5 to change these settings if necessary.

Before you start the OOBE:

1. Connect a PC with an installed Web browser.



The IP address for the NIC in the management PC must be on the same IP subnet (192.168.1.x) as the management port.

2. Start a Web browser on the PC connected to the xStack Storage Array's management port.
3. In the browser's address bar, type the following default IP address for the management console and press the Enter key:
`192.168.1.1`
4. Start the xStack Storage Array and proceed to Section 4.1.

4.1 Initial Startup and Welcome

When you start the xStack Storage Array for the first time, the system goes through its Power On Self Test, and then displays the Welcome screen shown in Figure 4-1. Click the **Start** button in the Welcome screen to continue and proceed to Section 4.2.



Figure 4-1 Welcome Screen

4.2 Entering Initial Management Port Settings

After you click the **Next** button in the Welcome screen, the Management Port screen in Figure 4-2 appears. This screen lets you specify the settings that client computers will use to access the xStack Storage Array management console. The values you enter must be compatible with your local network and accessible to the client computers that will be accessing the xStack Storage Array management console. Complete the fields on this screen (see Table 4-1), then click the **Next** button when finished.



If you need to change these initial settings at a later time, use the procedures described in Chapter 5.

Figure 4-2 Management Port Screen

Table 4-1. Initial Management Port Settings

Setting	Description
IP Address	Enter the IP address that client computers must use to access the xStack Storage Array's management console. Make note of the new IP address for reference purposes.
Subnet	Enter the subnet mask that client computers must use to access the xStack Storage Array's management console. The NIC in the management PC will be modified to use the same subnet when you finish the OOB setup wizard.
Default Gateway	Enter the default gateway that client computers must use to access the xStack Storage Array's management console.
Host name	The xStack Storage Array is assigned a default host name. If desired, you can change this name to one that is meaningful to you.

4.3 Entering Administrator Account Password

After you click the **Next** button from the Management Port screen, the Administrator Account screen in Figure 4-3 appears. This screen lets you specify the administrator password that will be required to log in to the management console. Complete the fields on this screen (see Table 4-2), then click the **Next** button when finished.



If you need to change these initial settings at a later time, use the procedures described in Chapter 5.

D-Link[®]

Administrative access to the xStack is authenticated by user name and password.

You can use the management console to add additional administrative users after this initial setup is complete.

Enter and confirm a password for the "admin" account, or leave these entries blank to keep the current password

User Name: admin

Password:

Re-type Password:

Previous Next

Figure 4-3 Administrator Account Screen

Table 4-2 Administrator Account Settings

Setting	Description
Password	Enter the password for the administrator account. This case-sensitive password must be specified when logging in to the management console. For security, each typed character appears as an asterisk (*).
Re-type Password	Retype the same case-sensitive password typed in the Password field. For security, each typed character appears as an asterisk (*).



Firmware 1.4.0.27 and later will not allow the primary admin account “admin” to be deleted. For security, please be sure to change the default admin account’s password.

4.4 Entering the System Date and Time

After you click the **Next** button from the Administrator Account screen, the Date/Time screen in Figure 4-4 appears. This screen lets you specify the system date and time and time zone. Complete the fields on this screen (see Table 4-3), then click the **Next** button when finished.



If you need to change these initial settings at a later time, use the procedures described in Chapter 5.



Figure 4-4 Date/Time Screen

Table 4-3 Date/Time Settings

Setting	Description
Date and Time	Use the controls to the right of this field to select the appropriate system date and time, or click the calendar icon and select a date from the popup calendar.
Time Zone	Select the appropriate timezone from the drop-down list.

4.5 Setting Up Email Notifications

After you click the **Next** button from the Date/Time screen, the Email Notification screen in Figure 4-5 appears. This screen lets you enable and configure the xStack Storage Array to send notifications by email when a serious event occurs, such as if a S.M.A.R.T. threshold has been exceeded. To use this feature, the xStack Storage Array management port must be able to communicate with your LAN's Simple Mail Transfer Protocol (SMTP) server. Complete the fields on this screen (see Table 4-4), then click the **Next** button when finished.



To receive email notifications, be sure that your SMTP server is set up correctly and that you are able to use it for your normal emails.



If you need to change these initial settings at a later time, use the procedure described in Chapter 5.

D-Link
xStack Storage

The xStack can send email messages to notify an administrator of conditions that may require his attention.

This page allows you to enable this feature, and to specify the address to which the message will be sent and the email server to be used. Please verify the configuration of your email server prior to enabling this feature. You can configure this feature later with the management console if desired.

Enable Email Support:

SMTP Server IP Address:

Port Number:

From:

To:

Figure 4-5 Email Notification Screen

Table 4-4 Email Notification Settings

Setting	Description
Enable Email Support	Click this option to enable email notifications from the xStack Storage Array.
SMTP Server IP Address	Enter an IP address that identifies the xStack Storage Array as the source of the email.
Port Number	Enter the SMTP port on which the mail server will be listening for email alerts from the xStack Storage Array (default is 25).
From	Enter the email address of a user. Each email sent by the xStack Storage Array will be identified as being sent from this user.
To	Enter the email address where notifications are to be sent. This can be an individual email address or a distribution list.

4.6 Completing the OOBE Setup Wizard

After you click the **Next** button from the Email Notification screen, a screen similar to the one in Figure 4-6 appears, with a summary of the initial settings you specified in the OOBE setup wizard. Review the settings to ensure they are correct. If you need to change a setting, click the **Previous** button until you return to the appropriate screen, change the setting, and then click the **Next** button until you return to the screen below.



Figure 4-6 Screen Summarizing Initial Settings

When you are certain that the initial settings are correct, click the **Finish** button. A screen similar to the one in Figure 4-7 appears and the xStack Storage Array restarts using the initial settings you specified. If you changed the IP address for the management port, the screen alerts you to change the settings on your management PC, so you can access the xStack Storage Array console.



Figure 4-7 Restart Message

Chapter 5 Configuring the xStack Storage Array

This chapter describes how to use the Web manager interface to change the xStack Storage Array's initial settings, which you specified in the OOBE setup wizard, and factory-default settings. Web Manager is a Java-based graphical point-and-click Web interface that can be accessed from any PC with Internet access. You can also access the Web Manager using a PC connected directly to the xStack Storage Array management port (see Section 3.9).

The topics in this chapter include:

- Section 5.1, Launching the xStack Storage Management Console on page 46
- Section 5.2, Understanding the Main Screen on page 49
- Section 5.3, Managing User Accounts on page 55
- Section 5.4, Managing the xStack Storage Array on page 57
- Section 5.5, Changing Initial Configuration Settings on page 96
- Section 5.6, Managing xStack Storage Array Configurations on page 99
- Section 5.7, Restarting the xStack Storage Array on page 101
- Section 5.8, Shutting Down the Management Console on page 102
- Section 5.9, Shutting Down the xStack Storage Array on page 102

5.1 Launching the xStack Storage Management Console

The following procedure describes how to launch the xStack Storage Array's management console. This procedure assumes that:

- The xStack Storage Array is powered-up.
- A PC with an installed Web browser and Java v1.4.2 is connected to the management port. If the PC needs Java v1.4.2, you can download it from the xStack Storage Array Login screen. For this reason, the management PC should have Internet access.
- The OOBE has already been performed (refer to 4.1).
- The IP address on the PC's NIC is on the same IP subnetwork (e.g., 192.168.1.x) as the management port. (If you changed the IP address since the last startup, please adjust your PC's configuration accordingly.)

To launch the management console:

1. Start a Web browser on the PC connected to the xStack Storage Array's management port.
2. In the browser's address bar, type the IP address you specified during the OOBE (see Chapter 4) and press the Enter key. The default IP address is:

192.168.1.1

If the xStack Storage Array is still in its boot-up process and not fully operational, then a screen similar to Figure 5-1 appears that monitors the process of the startup.

When the array has booted, then the browser connects to the xStack Storage Array and a Login screen appears. (See Figure 5-2)



If you receive an IP address not found message, be sure you entered the appropriate IP address. Then try to log in to the xStack Storage Array again.

If your browser displays an xStack Storage page instead of the Login screen, read the directions. If the page indicates that your computer does not have Java installed, click where requested to download and install Java and Java Web Start. When this process completes, the Login screen appears.

3. In the appropriate text boxes, enter the username and password as configured in the OOBE setup wizard. The default username is **admin** and the default password is **admin**.



If desired, you can click the **More** button to view the IP address you will be connecting to and change it if necessary.

4. Click the **OK** button. A screen appears with a progress bar as the connection is made to the xStack Storage Array. When the connection is made, the main screen appears (see Figure 5-3).



We Power Network Storage!™

powered
WEBSERVER

Please wait while the xStack Storage starts up

- 0 - Processing: Make RAM-disk directory
- 1 - Processing: Initialize signals
- 2 - Processing: Setup shared memory segment
- 3 - Processing: Get hardware info
- 4 - Processing: Run web server
- 5 - Processing: Run SSL web server
- 6 - Processing: Initialize Email Notification Thread
- 7 - Processing: firmware upgrade check for persistence data
- 8 - Processing: Runst i3000
- 9 - Processing: Open i3000 device
- 10 - Processing: Initialize the System Memory and Enable the Buffer Memory
- 11 - Processing: Run application - ncytest2
- 12 - Processing: Run application - rana
- 13 - Processing: Initialize MMSG socket
- 14 - Processing: Check the emp log file
- 15 - Processing: Run application - emp
- 16 - Processing: Run application - i3000
- 17 - Processing: Run i3000
- 18 - Processing: Run i3000
- 19 - Processing: Run application - empMain
- 20 - Processing: Initialize battery manager
- 21 - Processing: Run application - emdserver
- 22 - Processing: Setup the i3000
- 23 - Processing: Load i3000 firmware

Figure 5-1 xStack Storage Array Startup Screen



Figure 5-2 xStack Storage Log in Screen

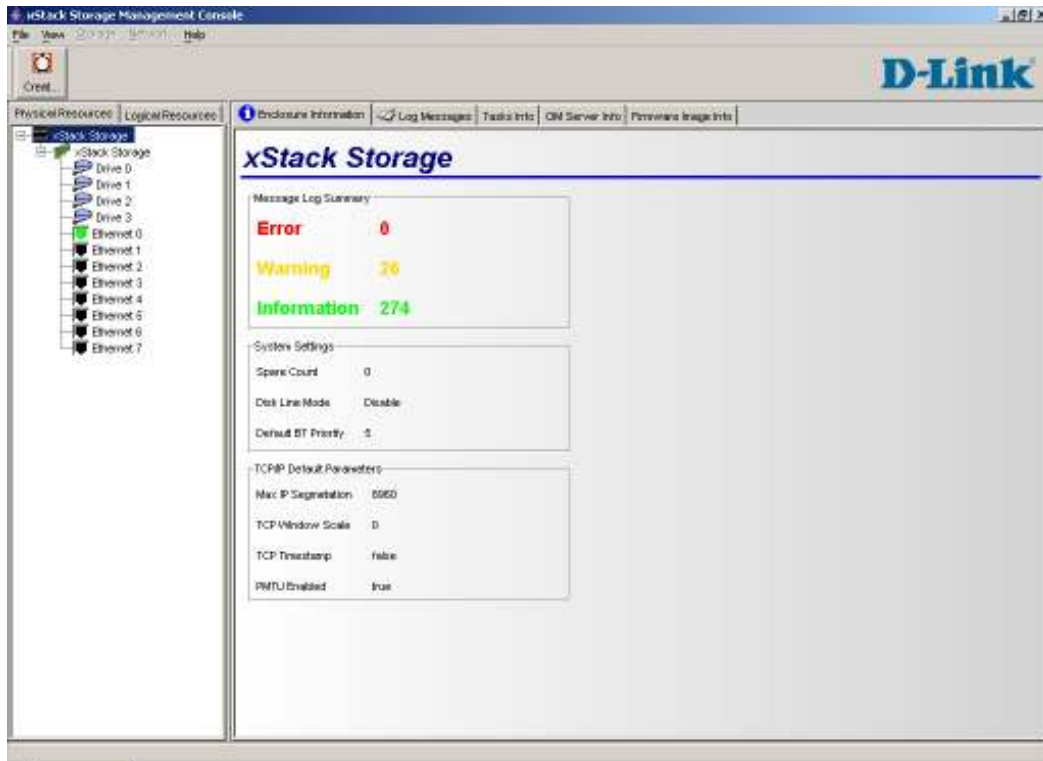

Figure 5-3 xStack Storage Management Console Main Screen

5.2 Understanding the Main Screen

Figure 5-4 shows the areas of the xStack Storage Array's management console main screen.

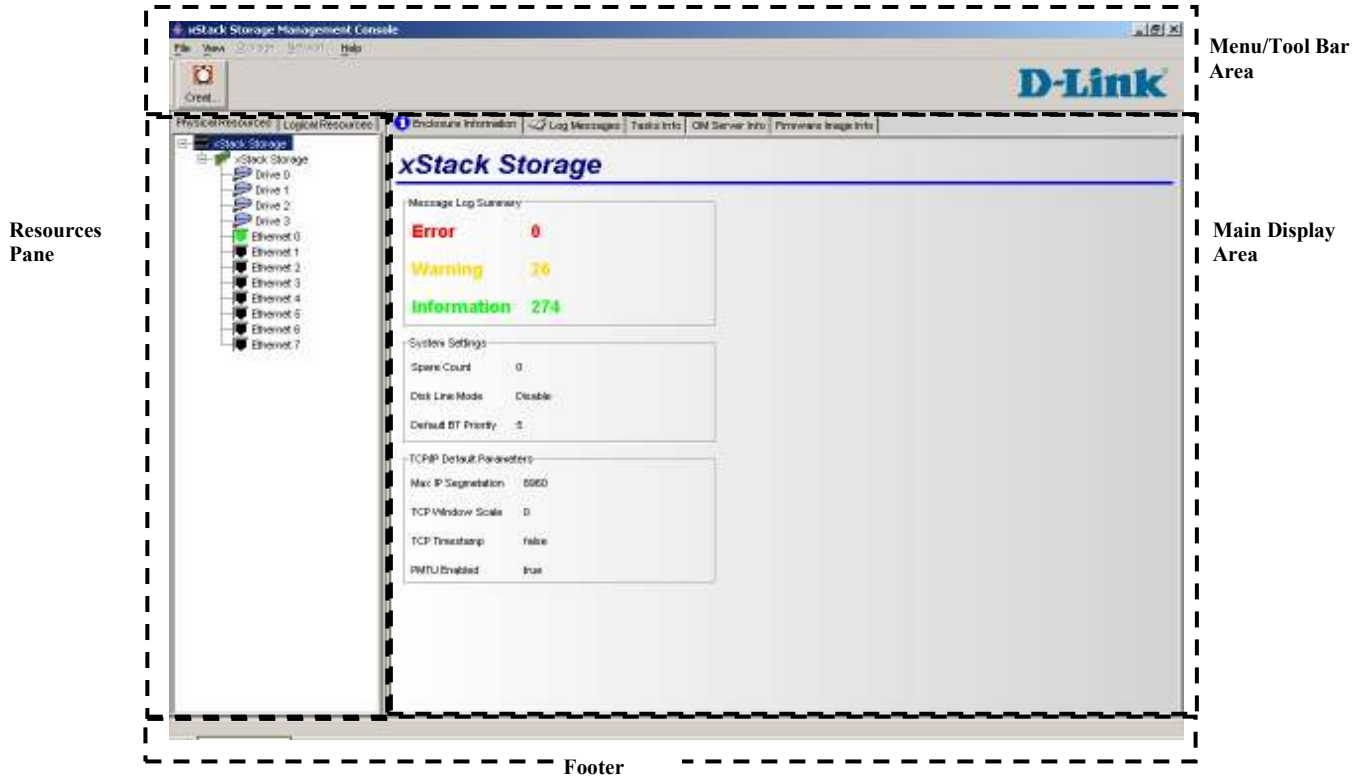

Figure 5-4 Parts of the xStack Storage Management Console Main Screen

5.2.1 Menu / Tool Bar Area

The Menu/Tool Bar Area appears at the top of the xStack Storage management console window. This area contains the following components (Figure 5-5):

- **Title bar.** The title bar shows the name of the application. On the right side of the title bar are the standard Windows buttons for minimizing, maximizing, and closing the xStack Storage management console application.
- **Menu bar.** The menu bar is located below the title bar. The menu bar contains the menus you can select to perform a range of storage tasks. The xStack Storage management console provides the following menus:

- **File**
- **View**
- **Storage**
- **Network**
- **Help**

Depending on the activity you are performing, some menus may be gray and unavailable.

- **Tool bar.** The tool bar is located below the menu bar. The tool bar provides convenient shortcuts for menu options and other operations. The tools that appear on the tool bar vary, depending on the task you are performing.

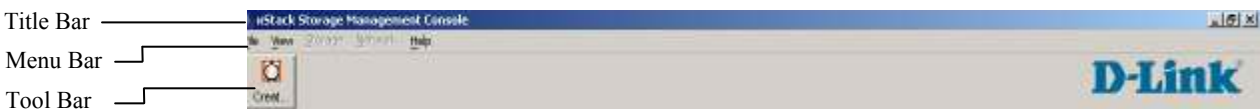
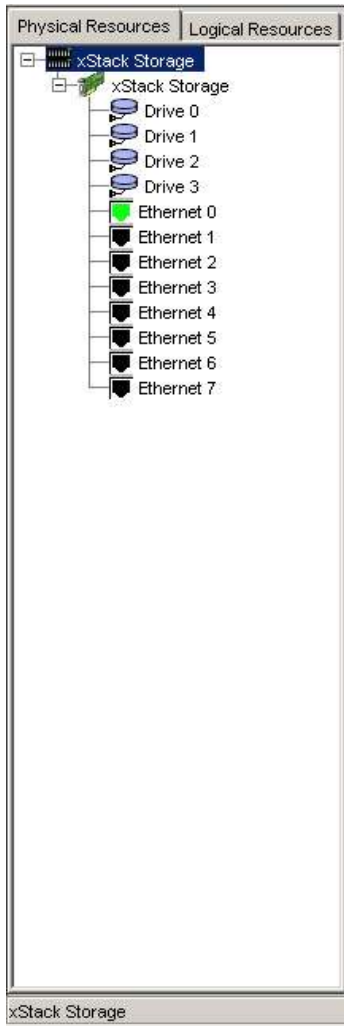

Figure 5-5 Menu/Tool Bar Area

5.2.2 Resources Pane

The resources pane shows the **Physical Resources** tab or **Logical Resources** tab. Only one tab can be active at a time. To switch between them, click the tab name. These tabs work the same way as in Windows Explorer. A plus sign (+) means an item contains subitems. To see the subitems, double-click the item or click the plus sign next to it. When an item is expanded, a minus sign (-) replaces the plus sign. Clicking the minus sign collapses the item.

In this Guide, you will see references to the “active tab.” The active tab is the tab that is on top (in front) of the other tab. Only one tab can be active at a time. To switch between the **Physical Resources** tab and the **Logical Resources** tab, click the tab name. (See Figure 5-6)



Example of Physical Resources Tab

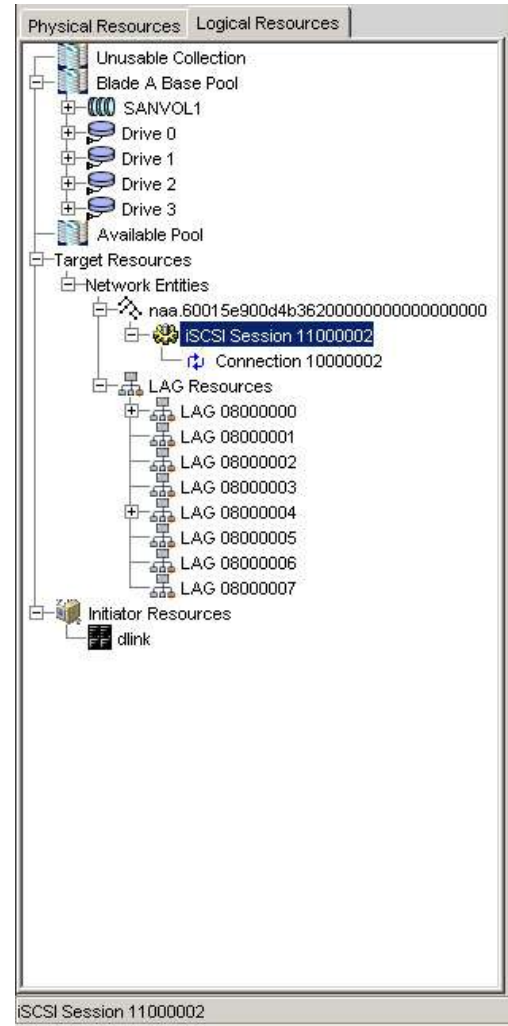



Example of Logical Resources Tab

Figure 5-6 Resources Pane

5.2.2.1 Physical Resources Tab

The **Physical Resources** tab contains the following physical resources:









- The xStack Storage unit (.
- The physical drives attached to the xStack Storage Array (.
- The Ethernet ports on the xStack Storage Array (). To enhance viewing, the port icons are color coded (black = link is down, green = link is up).

5.2.2.2 Logical Resources Tab

The **Logical Resources** tab shows the following logical resources:

- **Unusable Collection** (). Shows drives that have been pulled out of the xStack Storage Array. Two types of drives appear in the **Unusable Collection**:
 - Drives not available for use because they have failed and have not been removed from the enclosure.
 - Drives that were found to be used previously by an xStack Storage Array.

Initializing a drive in the **Unusable Collection** moves it to the **Available Pool**, where volumes can be rebuilt if necessary.

- **Blade A Base Pool** (). Shows drives () currently being used to hold volumes () or ready to be used to hold volume data.
- **Available Pool** (). Shows the available drives () that can be added to the storage pool. Initially, all drives appear here until they are needed for use in a volume or dragged and dropped by the administrator into the **Blade A Base Pool**. A spare drive is normally kept here to keep it available for use should any other drive fail.
- **Target Resources**. Shows the network entities () and LAGs (.
- **Initiator Resources**. Shows the iSCSI initiators (.



If a volume is reduced (for example, if a physical drive fails), the firmware will automatically move a drive from the **Available Pool** to the **Blade A Base Pool** if there is insufficient space to otherwise start a rebuild operation for that volume.

5.2.3 Main Display Area

Some items in the **Physical Resources** and **Logical Resources** tabs have storage or system information associated with them. When you click such an item, the storage or system information is displayed in one or more “tabbed” screens in the main display area. The tabbed screens resemble index cards. If you click the top xStack Storage item in the left pane of either the **Physical Resources** tab, for example, four tabs appear in the main display area (see Figure 5-7). You can then click the tab to view the information on it.

For more information about the screens that can appear in the main display area, refer to Chapter 6.

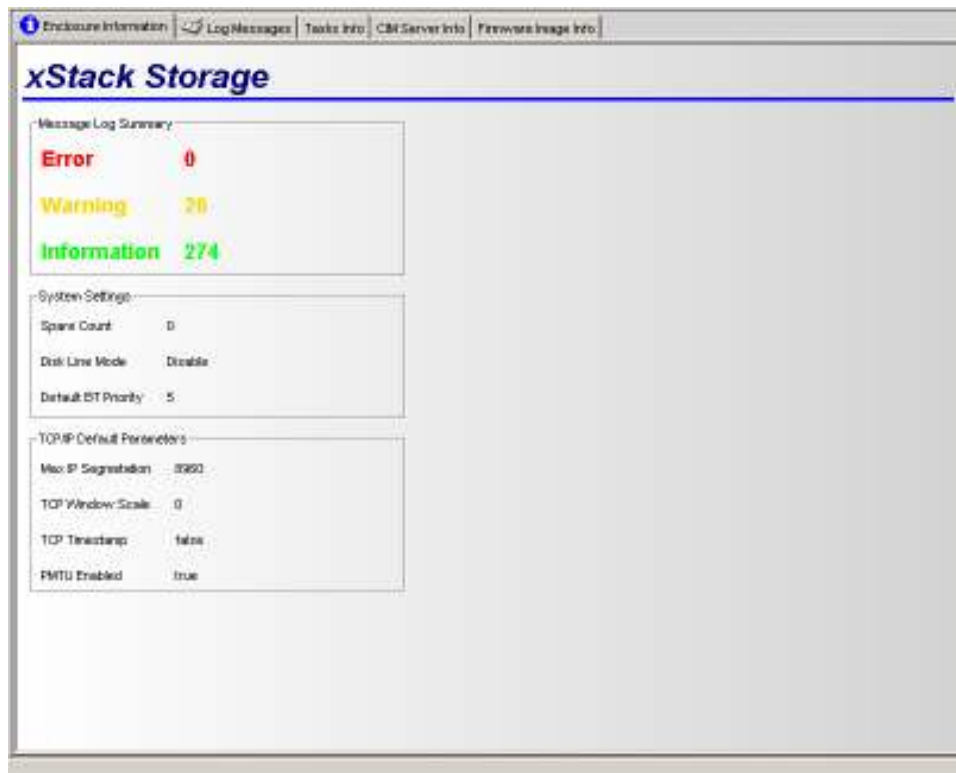

Figure 5-7 Main Display Area

5.2.4 Footer

The footer appears at the bottom of the xStack Storage management console window. The footer shows status information when appropriate. If you select **Blade A Base Pool** in the **Logical Resources** tab, for example, the words **Blade A Base Pool** appear in the footer (see Figure 5-8).

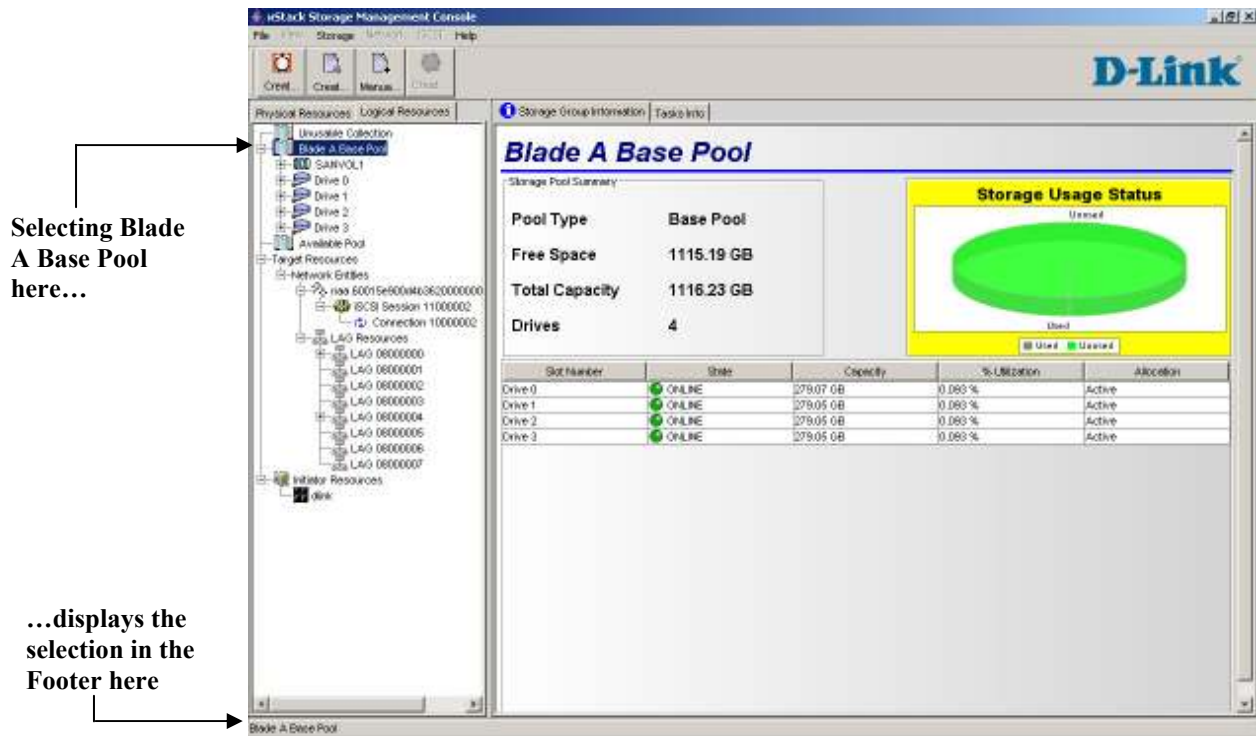

Figure 5-8 Example of Message in the Footer

5.3 Managing User Accounts

The xStack Storage Array comes with a single user account called admin. A user account must be set up for each additional user who will be authorized to access the management console. The user account consists of a unique username and password, and permissions for managing storage and/or adding or editing user accounts.

By default, the admin user can manage storage and add and edit user accounts. When the admin user sets up a user account, he specifies storage and user account permissions for each user. The permissions work independently, so the admin could:

- Let a user manage storage, without being able to add or edit user accounts.
- Let a user add or edit other user accounts, without being able to manage storage.
- Limit a user to read-only permissions that let the user view management console screens, without being able to manage storage or add/edit user accounts.



The admin account cannot be deleted in firmware version 1.4.0.27 and above. For security, please be sure to change the password for this account. However, if you lose the password for the admin account, you may use the diagnostic port to reset the password (see Appendix E).

5.3.1 Setting Up User Accounts

To set up user accounts, use the following procedure.

1. Be sure the **Physical Resources** tab is the active tab.
2. On the **View** menu, click **User Accounts**. The User Accounts screen appears, with a list of the user accounts that have been defined (see Figure 5-9).

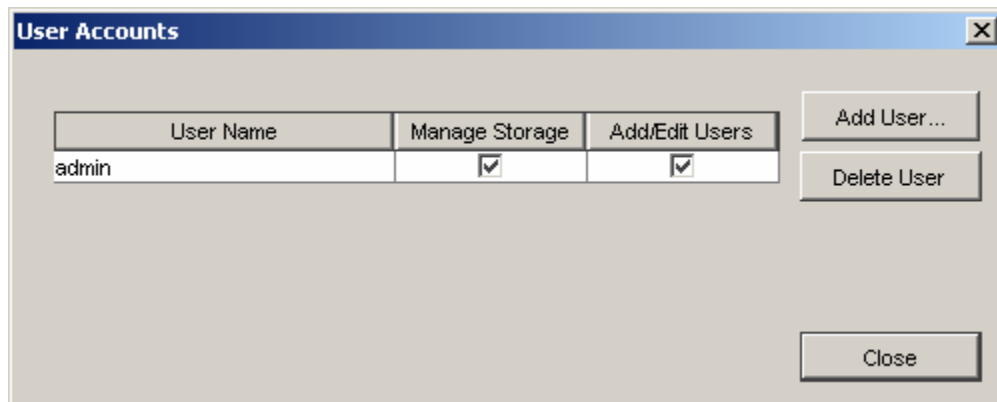

Figure 5-9 User Accounts Screen

3. Click the **Add User** button. The Add New User dialog box appears (see Figure 5-10).

Figure 5-10 Add New User Dialog Box

4. Complete the fields in the dialog box (see Table 5-1).
5. Click **OK**. The user you defined appears in the User Accounts screen.
6. Click the **Close** button to exit the User Accounts screen.

Table 5-1 Add New User Dialog Box Settings

Setting	Description
Username	Enter the name of the user whose account you are creating.
Password	Enter the password for this user account. The user must specify this case-sensitive password when logging in to the management console. For security, each typed character appears as an asterisk (*).
Confirm password	Retype the same case-sensitive password typed in the Password field. For security, each typed character appears as an asterisk (*).
Allow to manage storage	Check this option to let this user manage storage on the xStack Storage Array.
Allow to manage user accounts	Check this option to let this user define and modify user accounts.



If you leave **Allow to manage storage** and **Allow to manage user accounts** unchecked, the user will be able to view management console screens, but will not be able to change storage settings and user accounts.

5.3.2 Deleting User Accounts

If you no longer need a user account, use the following procedure to delete it.

1. On the **View** menu, click **User Accounts**. The User Accounts screen appears, with a list of the user accounts that have been defined.
2. Click the user whose account you want to delete, then click the **Delete User** button.

5.4 Managing the xStack Storage Array

This section shows you how to configure and manage storage on the xStack Storage Array.

5.4.1 Working with Volumes

A volume is a set of storage blocks organized and presented for use by a customer's server (an iSCSI initiator node). Each volume must be associated with a storage pool, which limits the drives that can be used to hold data for that Volume (only drives in that pool can be used for this volume). Only the Blade A Base Pool can be used for volumes.

The iSCSI initiator node sees the volume as a contiguous series of numbered blocks, called Virtual Logical Block Numbers (VLBNs), in the same way that it would see the storage space on a single disk drive. The xStack Storage Array builds a volume from extents. A volume typically consists of extents from several drives.

Volume can be organized in several ways (see Table 5-2).

Table 5-2 Ways to Organize Volumes

Organization	Definition	Redundant	Striped	Equivalent to RAID Level
JBOD	One copy of the data is written to the selected Extents.	No	No	-
Mirror	Two copies of all data are written to independent Extents.	Yes	No	RAID 1
Stripe	Distributes one copy of the data among several drives to improve the speed of access.	No	Yes	RAID 0
Mirrored Stripe	Distributes the data among several drives and then keeps a mirror copy of the blocks on each drive	Yes	Yes	RAID 1+0
Parity	Distributes one copy of the data among several drives and adds parity blocks spread throughout the volume to protect against the loss of any single drive.	Yes	Yes	RAID 5

5.4.1.1 Creating Volumes

Adding volumes defines what volumes are accessible through the target. Using the management console, you can create volumes automatically or manually.

- The automatic method is the fastest way to create volumes. See Section 5.4.1.1.1.
- The manual method lets you customize and fine-tune volumes. See Section 5.4.1.1.2.

5.4.1.1.1 Creating Volumes Automatically

The following procedure describes how to create volumes automatically with the Create Volume Wizard. With this method, the administrator answers questions about the required redundancy, size, and usage characteristics of the volume. The xStack Storage Array then determines the remaining parameters needed to allocate the storage space and create the volume. As you create volumes, record the information in Appendix B.

1. In the **Logical Resources** tab, click **Blade A Base Pool**.
2. Perform one of the following steps in the **Logical Resources** tab:
 - Click the **Create Volume** button on the toolbar.
 - On the **Storage** menu, click **Create Volume**.
 - Right-click **Blade A Base Pool** and click **Create Volume**.

Any of these steps starts the Create Volume Wizard and displays the Select Volume Type to Create screen (see Figure 5-11).

The screenshot shows a 'Volume Wizard' dialog box. The title bar says 'Volume Wizard'. The main content area has a 'D-Link' logo on the left and the text 'Select Volume Type to Create' on the right. Below this, it says 'Please enter the volume name, volume size'. There are three input fields: 'Name' (a text box), 'Size' (a text box with a 'GB' dropdown menu), and 'Data Redundancy' (radio buttons for 'None', 'Parity', and 'Mirror'). At the bottom, there are 'Next >', 'Cancel', and 'Help' buttons. A copyright notice at the bottom left reads 'Copyright © 2002-2005, by iStor Networks Inc.'

Figure 5-11 Create Volume Wizard Screen – Select Volume Type to Create Screen

- Complete the fields in the screen (see Table 5-3), then click the **Next** button. The Access and Efficiency Settings screen appears (see Figure 5-12).



If you selected **None** or **Mirror** for **Data Redundancy**, only **Access Bandwidth Weight** appears in the Access and Efficiency Settings screen.

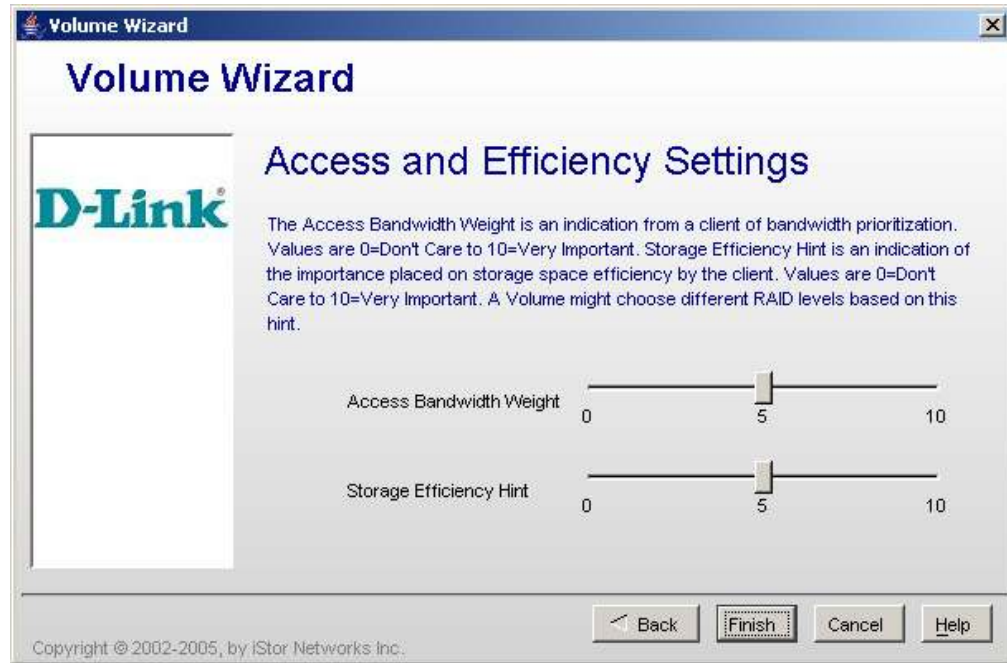

Figure 5-12 Create Volume Wizard Screen – Access and Efficiency Settings Screen

- The default settings for **Access Bandwidth Weight** and **Storage Efficiency Hint** produce good volume organizations for each redundancy setting that use some, but not all, drive resources. If you change these settings (see Table 5-4), the number of members chosen for the volume depends on the number of drives available when the volume is created. Small settings use a small number of members. As setting values increase, the number of members increases slowly. When maximum values are reached, the xStack Storage Array uses all possible drives in the volume’s pool and the **Available Pool** for a volume. (Spare count is the only limit to the number of drives obtained from the **Available Pool**.)
- Click the **Finish** button. The main screen reappears, the volume you created appears under **Blade A Base Pool** in the **Logical Resources** tab, and a plus sign appears next to **Blade A Base Pool**. Clicking the plus sign displays the volume you created.

Table 5-3 Create Volume Wizard - Select Volume Type to Create Settings Screen Settings

Setting	Description
Name	Enter the name of the volume you are creating.
Size	Enter the size of the volume you are creating. Do not type a decimal point. Use the drop-down box to select the volume capacity (MB, GB, TB, etc.). All volumes must be at least 1 MB in size.
Data Redundancy	Select whether the volume will have no data redundancy or parity or mirror redundancy. For an explanation of these selections, see Table 5-2.

Table 5-4 Create Volume Wizard - Access and Efficiency Settings Screen Settings

Setting	Description
Access Bandwidth Weight	Specifies how much bandwidth the volume will use (i.e., how much initiator I/O activity can be expected for the volume). The larger the number, the greater the I/O. Select a large volume to have the initiators achieve fast access to the volume compared to the other volumes on xStack Storage Array. A large value selects a larger number of stripe members. The method the xStack Storage Array uses to select the organization and number of members is described in Table 5-5.
Storage Efficiency Hint	Specifies the xStack Storage Array's member count selection. A large value increases disk space more efficiently (i.e., uses less space for redundancy data) and requests a larger number of members (which costs less space for parity overhead).

Table 5-5 Volume Organization and Members Based on Redundancy and Access Bandwidth Weight

Redundancy	Access Bandwidth Weight Value		
	0	1	Large Values
None	JBOD organization (1 member)	Stripe organization with 2 members	Stripe organization with more members
Mirror	Mirror organization (2 members)	Mirrored stripe organization with 2 stripe members	Mirrored stripe organization with more stripe members
Parity	Parity organization with 3 members	In combination with the Storage Efficiency Hint, this selects Parity organization with more members	



In a mirrored stripe organization, there are always two members for each stripe member to allow for the duplicate copy of the data.



After a volume is created, you can use the **Advanced** tab to write-protect the volume and suppress Synch Cache commands from the host (see 5.4.1.4).

5.4.1.1.2 Creating Volumes Manually

The following procedure describes how to create volumes manually. With this method, you select the organization and other parameters, and specify drives that can be used for the volume. The xStack Storage Array then finds the storage space on the given drives to allocate and create the Volume. As you create volumes, record the information in Appendix B.

1. In the **Logical Resources** tab, click the plus sign next to **Blade A Base Pool**. All drives available for volume creation appear under **Blade A Base Pool**.
2. In the **Logical Resources** tab, click the plus sign next to **Available Pool**.
3. If drives to be used for this volume are not already in the Blade A Base Pool, those drives need to be moved to that Pool. To do this, drag one of the desired drives from **Available Pool** to **Blade A Base Pool**. Repeat this step for each additional drive that you want included in the volume.
4. In the **Logical Resources** tab, click **Blade A Base Pool**.

5. Perform one of the following steps in the **Logical Resources** tab:
 - Click the **Manual Create Volume** button on the toolbar.
 - On the **Storage** menu, click **Manual Create Volume**.

The Manual Create Volume Wizard launches and the Select Volume Type to Create screen appears (see Figure 5-13).



Figure 5-13 Manual Create Volume Wizard - Select Volume Type to Create Screen

6. Complete the fields in the screen (see Table 5-6).
7. Click the **Next** button. The Select the Drives screen appears (see Figure 5-14).

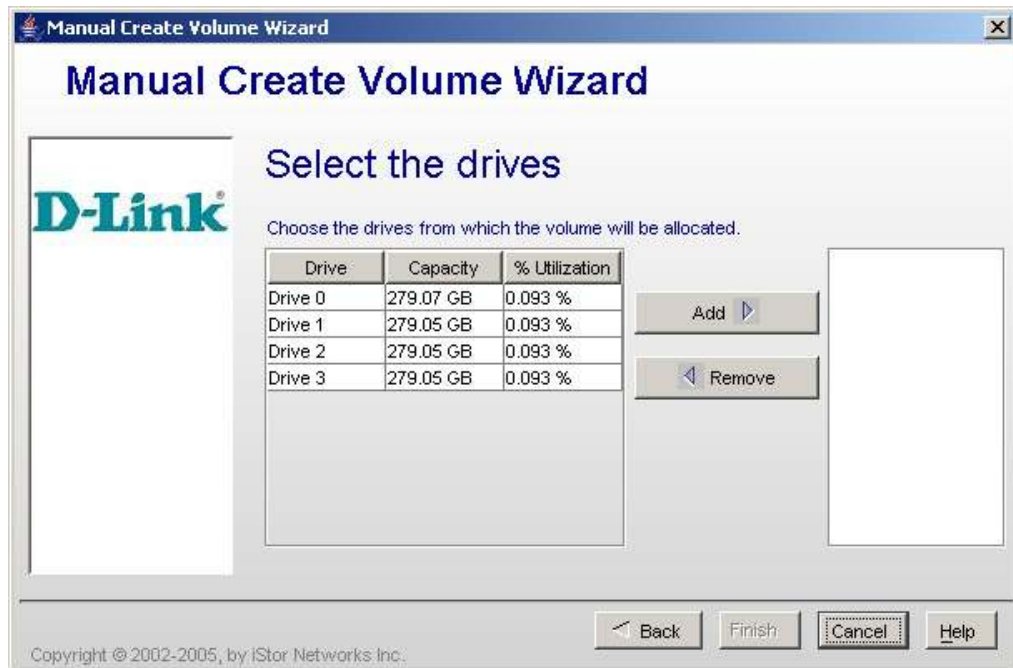

Figure 5-14 Manual Create Volume Wizard - Select the Drives Screen

8. In the left box, select the drives from which the volume will be allocated, then click the **Add** button. Observe the following guidelines when selecting drives:
 - JBOD volumes support a minimum of 1 drive and can span across additional drives if the capacity required exceeds that which a single drive can provide.
 - Mirrored Stripe volumes support an even number of drives, from 4 to 14.
 - Parity volumes support 3 to 15 drives.
 - Mirror and striped volumes support 2 to 15 drives.



You can select more than one drive in the left box:

- To select contiguous drives, click the first drive; then hold down the Shift key and click the last drive. All drives between the first and last drives are selected.
- To select noncontiguous drives, click the first drive; then hold down the Ctrl key and click each additional drive you want to select.
- To deselect a drive, hold down the Ctrl key and click the drive.

To remove a drive from the right box, click the drive in the right box and click **Remove** to return the drive to the left box.

9. Click the **Finish** button. The main screen reappears and the volume you created appears under **Blade A Base Pool** in the **Logical Resources** tab. The drives that make up your volume appear in the main display.



If you select an unacceptable configuration, the **Finish** button remains gray and unavailable until you correct the configuration. Examples are an odd number of drives for a mirrored stripe configuration, 1 or 2 drives for a parity volume, and 1 drive for a Mirror configuration.

If you specify a volume larger than the selected drives can support, an error message appears after you click the **Finish** button. Click **OK** to remove the message, then repeat this procedure and specify a smaller volume.

Table 5-6 Manual Create Volume Wizard - Select Volume Type to Create Screen Settings

Setting	Description
Name	Enter the name of the volume you are creating.
Size	Enter the size of the volume you are creating ((MB, GB, TB, etc.). Do not type a decimal point. Use the drop-down box to select the volume capacity:
Configuration	Select the desired organization (JBOD, Stripe, etc.). Table 5-2 lists the volume organizations.
Chunk Size	Select the size (32K, 64K, etc.) of each chunk from one of the commonly used chunk sizes. If you selected JBOD or Mirror as your configuration setting, the Chunk Size setting is gray and unavailable.



After a volume is created, you can use the **Advanced** tab to write-protect the volume and suppress Synch Cache commands from the host (see 5.4.1.4).

5.4.1.2 Expanding a Volume

If you want to add capacity to a volume, expand the volume to increase its physical capacity.

1. In the **Logical Resources** tab, click the volume whose capacity you want to expand.
2. On the **Storage** menu, click **Expand Volume**. The Expand Volume dialog box appears (see Figure 5-15).

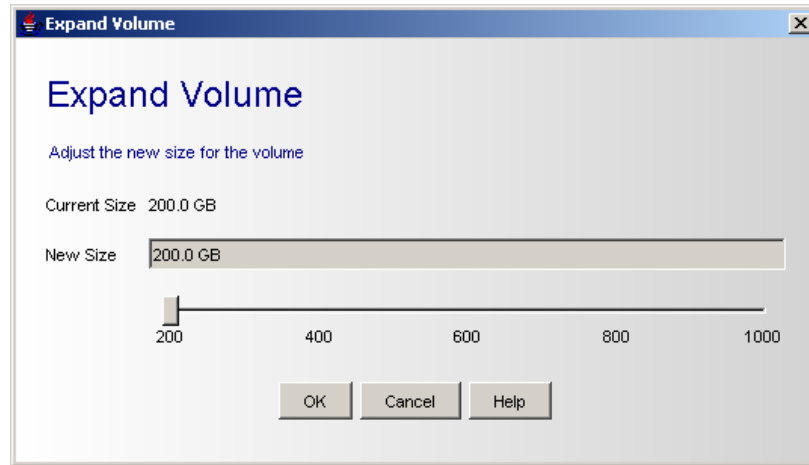

Figure 5-15 Expand Volume Dialog Box

3. Use the **New Size** slide bar to increase the size of the volume.
4. Click **OK**.
5. When the Expand Volume started message appears (see Figure 5-16), click **OK**.



If the selected volume cannot support the specified size, an error message appears. If this occurs, specify a smaller size.

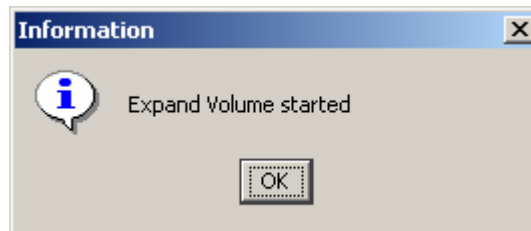

Figure 5-16 Expand Volume Message

5.4.1.3 Reconfiguring Volumes

After you create a volume, you can reconfigure it if you need to change its size or its organization.

1. In the **Logical Resources** tab, click the volume you want to reconfigure.
2. Perform one of the following steps:
 - On the **Storage** menu, click **Reconfigure**.
 - Press the right mouse button and click **Reconfigure**.

Either step starts the Auto Create Volume Wizard and displays the Select Volume Type to Create screen. For each screen in the Wizard, the xStack Storage Array shows the values for the Volume's current organization. Except for the Volume's Name, which is shown in gray, all fields can be changed. For example, you can change the **Data Redundancy** check box from **None** to **Parity**, which would change the Volume's organization to **Parity**.

3. Review the settings in the displayed screen and change them as necessary.
4. Click the **Finish** button.

5.4.1.4 Advanced Volume Operations

When you click a volume under **Blade A Base Pool**, you can use the Advanced screen (see Figure 5-17 and for a closeup, Figure 5-18) to write-protect the volume and disable Sync Cache commands from a host.

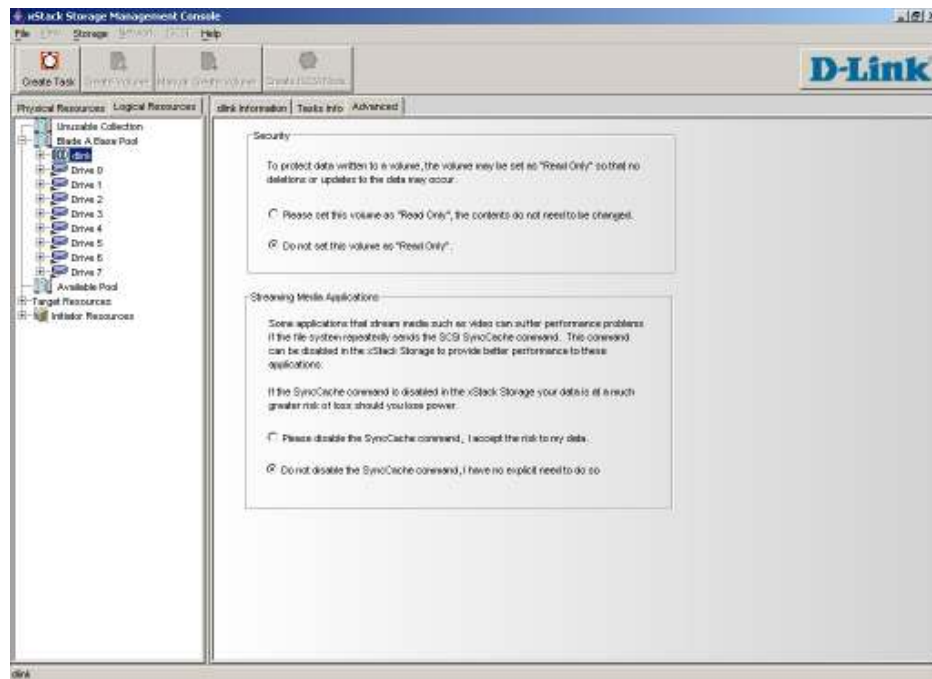

Figure 5-17 Advanced Screen

Security

To protect data written to a volume, the volume may be set as "Read Only" so that no deletions or updates to the data may occur.

Please set this volume as "Read Only", the contents do not need to be changed.

Do not set this volume as "Read Only".

Streaming Media Applications

Some applications that stream media such as video can suffer performance problems if the file system repeatedly sends the SCSI SyncCache command. This command can be disabled in the xStack Storage to provide better performance to these applications.

If the SyncCache command is disabled in the xStack Storage your data is at a much greater risk of loss should you lose power.

Please disable the SyncCache command, I accept the risk to my data.

Do not disable the SyncCache command, I have no explicit need to do so

Figure 5-18 Advanced Screen - Closeup

5.4.1.4.1 Write-protecting Volumes

Write-protecting a volume protects the data on the volume from being copied over or deleted either intentionally or by accident. On the "security" area of this screen, selecting **Please set this volume to "Read-Only"** adds write-protection to the volume, while selecting **Do not set this volume as "Read-Only"** removes write-protection. If an attempt is made to write data on a write-protected volume, the xStack Storage Array reports this attempt to the initiator requesting access to the volume and returns an error should any initiator try to write data. If the **Read-Only** selection is changed on this screen, the change takes effect immediately.

5.4.1.4.2 Disabling Sync Cache Commands

Some applications that stream media such as video can suffer performance problems if the host file system sends the SCSI Sync Cache command repeatedly. This command tells the xStack Storage Array to write to disk all data residing in cache. If you run applications that are sensitive to the Sync Cache command, you can configure the xStack Storage Array to ignore Sync Cache commands from the host. Doing so, however, places your data at greater risk than if the Sync Cache command was not ignored. . If the Sync Cache command selection is changed, the change takes effect immediately.

5.4.1.5 Deleting Volumes

If you no longer need a volume, use the following procedure to delete it.



You cannot delete a volume that is actively performing I/O for an iSCSI initiator. If you try to do so, the error “Volume Busy” is issued. If you really want to delete such a volume, log out of the target node and try to delete the volume again.

1. In the **Logical Resources** tab, click the volume you want to delete.
2. Perform one of the following steps:
 - On the **Storage** menu, click **Delete Volume**.
 - Press the right mouse button and click **Delete Volume**.A message asks whether you want to delete this volume.
3. Click **Yes** to delete the volume. (Or click **No** to keep the volume.) If you clicked **Yes**, a message tells you that the volume has been deleted.

Click **OK** to remove the message.

5.4.1.6 Performing a Parity Scan on a Volume

Using the management console, you can scan a parity volume for errors. This task reads every block in the volume to ensure that parity is correct. If parity errors are found, this task corrects the errors.

1. Click the volume on which you want to perform the parity scan.
2. Perform one of the following steps:
 - On the **Storage** menu, click **Parity Scan**.
 - Right-click and click **Parity Scan**.

Either step starts the scan operation and displays a message that the scan started successfully.

3. Click **OK** to remove the message.

After you start a parity scan task, you can use the Tasks Info screen to view the progress of the scan operation (see Section 6.9).

5.4.1.7 Performing a Media Scan on a Volume

Using the management console, you can scan a JBOD, stripe, mirrored stripe, or mirrored stripe media volume for errors. This task reads every block in the volume looking for errors as described for Media Scan to ensure that the media is correct. If media errors are found, this task corrects the errors.

1. Click the volume on which you want to perform the media scan.

2. Perform one of the following steps:
 - On the **Storage** menu, click **Media Scan**.
 - Right-click and click **Media Scan**.

Either step starts the scan operation and displays a message informing you that the scan started successfully.

3. Click **OK** to remove the message.

After you start a media scan task, you can use the Tasks Info screen to view the progress of the scan operation (see Section 6.9).

5.4.2 Adding iSCSI Initiators

Use the following procedure to tell the xStack Storage Array about the iSCSI initiators with which it will communicate.

1. Perform one of the following steps in the **Logical Resources** tab:
 - Click **Initiator Resources**. Then, on the **iSCSI** menu, click **Add Initiator**.
 - Right-click **Initiator Resources** and click **Add Initiator**.

Either step displays the Create Initiator screen (see Figure 5-19).

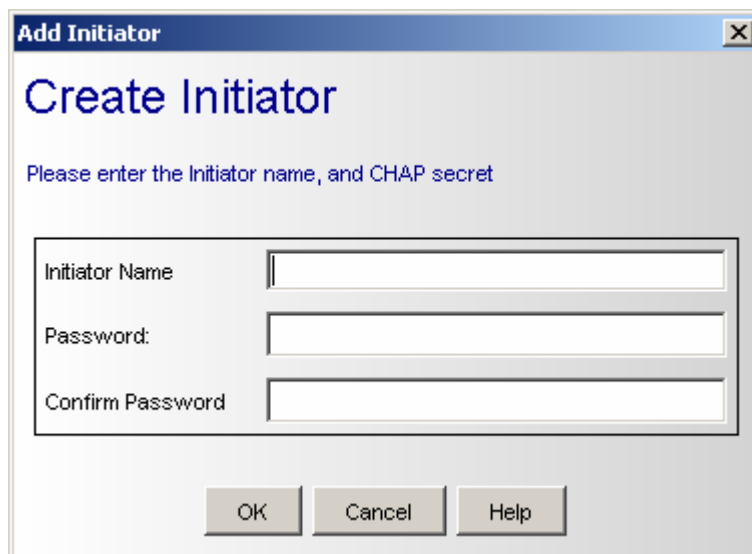

The screenshot shows a dialog box titled "Add Initiator" with a close button (X) in the top right corner. The main heading inside the dialog is "Create Initiator". Below the heading is a blue instruction: "Please enter the Initiator name, and CHAP secret". There are three text input fields stacked vertically. The first is labeled "Initiator Name", the second is labeled "Password:", and the third is labeled "Confirm Password". At the bottom of the dialog, there are three buttons: "OK", "Cancel", and "Help".

Figure 5-19 Add Initiator Wizard – Create Initiator Screen

2. Complete the fields in the screen (see Table 5-7).
3. Click the **OK** button. The main screen reappears and the iSCSI initiator you created appears under **Initiator Resources** in the **Logical Resources** tab.

After you add one or more iSCSI initiators, you can monitor their status from the Initiator Access Info screen (Section 6.13), Initiator Information screen (Section 6.17), and LUN Map Information screen (Section 6.18).

Table 5-7 Create Initiator Screen Settings

Setting	Description
Initiator Name	Enter the name of the iSCSI initiator you are creating. This name must exactly match the name defined for the iSCSI initiator to which the xStack Storage Array will connect; otherwise, the connection will fail.
Password	To use Challenge Handshake Authentication Protocol (CHAP) authentication when connecting to an iSCSI target, type the password that will be used during mutual CHAP authentication when an initiator authenticates a target. For security, each typed character appears as an asterisk (*). This setting is optional.
Confirm password	If you typed a password, retype the same the same case-sensitive password in this field. For security, each typed character appears as an asterisk (*).

5.4.3 Working with LAGs and VLANs

The xStack Storage Array manages the data ports on the enclosure's back panel using the concept of LAG ports. In a simple configuration, a LAG port associates a single Ethernet port (i.e., a physical data port) with a network portal that defines an IP address.

5.4.3.1 Creating LAGs and VLANs

By default, each physical data port on the xStack Storage Array corresponds to a LAG:

- **DSN-3200:** The default number of LAGs is eight.
- **DSN-3400:** The default number of LAGs is one. Since this model has only one data port, it does not support LAG capabilities.

In the default configuration, each data port corresponds to the LAG port of the same number. For example, the first LAG port (`LAG 08000000`) corresponds to Ethernet port 0 and to data port 0 on the enclosure's back panel. Similarly, `LAG 08000003` corresponds to Ethernet port 3 and to physical data port 3. No changes are necessary to use the xStack Storage Array in this configuration.

Link Aggregation is a way to combine (or “aggregate”) multiple data ports in parallel to act as a single logical connection with increased bandwidth, and the xStack Storage Array can do this, too.

Combining two or more data ports increases the overall bandwidth capability between the xStack Storage Array and your SAN, and creates resilient and redundant links. These capabilities are suited for demanding applications that run in high-performance environments, such as servers in enterprises, Web servers, and intranet servers, which can benefit from the high-bandwidth capabilities of link aggregation.

Figure 5-20 shows an example of a LAG created between the xStack Storage Array and a Gigabit Ethernet switch. In this example, multiple initiators (servers) that are used in a load balancing configuration can form one high-speed aggregated link. In this figure, the xStack Storage Array is connected to a Gigabit Ethernet switch using four 1 Gbps links. If one link fails between the xStack Storage Array and the switch, the other links in the LAG take over the traffic and the connection is maintained. A different example can be shown using the same figure but in a non-load balancing configuration and with a larger number of initiators aggregated into the LAG. In this example, there could be six initiators connected to the switch that can participate in the LAG. At any point in time, if one initiator is generating less traffic, the others can generate more traffic, up to a maximum of 4 Gbps and the switch will balance the load. Since a single initiator does not typically generate continuous data, this configuration can allow better overall bandwidth utilization.

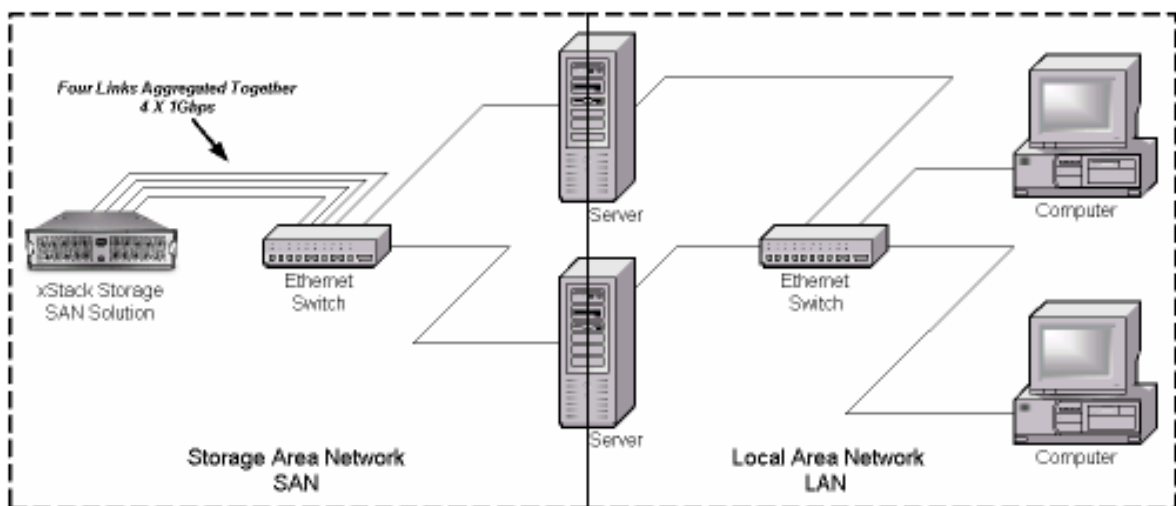

Figure 5-20. Example of Link Aggregation between the xStack Storage Array and a Gigabit Ethernet Switch

Using the following procedure, you can change this mapping so that a LAG consists of more than one physical port, depending on the requirements of the network (i.e., the more ports in the LAG, the more bandwidth and more redundancy that is available). When you create LAGs, you can indicate whether the LAG is to support a virtual LAN (VLAN). All xStack Storage Array models support eight VLANs, one for each IP address. As you create LAGs, record the information in Appendix B.

1. In the **Logical Resources** tab, click the plus sign next to **Target Resources**.
2. Click the plus sign next to **Network Entities**.
3. Click **LAG Resources**.
4. Perform one of the following steps:
 - On the **Network** menu, click **Create LAG**.
 - Right-click and click **Create LAG**.

Either step starts the Create Link Aggregation Group Wizard and displays the LAG Parameters screen (see Figure 5-21).



Figure 5-21 Create Link Aggregation Group Wizard - LAG Parameters Screen

5. Complete the fields in the screen (see Table 5-8).

Table 5-8 Create Link Aggregation Group Wizard - LAG Parameters Screen Settings

Setting	Description
MTU Size	This is a read-only field.
Ethernet Encapsulation	Select the Ethernet frame type to be used for fetching packets from upper-layer protocols, and placing header and footer information around the data before it traverses the network. <ul style="list-style-type: none"> ▪ Ethernet_II ▪ Ethernet_802.3
VLAN Supported	Check this box to have the LAG support a Virtual Network (VLAN).
Auto Negotiation	This option is unavailable.

6. Click the **Next** button. The Add/Delete Ethernet Ports screen appears (see Figure 5-22).



Figure 5-22 Create Link Aggregation Group Wizard - Add/Delete Ethernet Ports Screen

7. To add Ethernet ports, select one or more ports in the left box and click **Add** to move them to the right box.
8. To remove one or more Ethernet ports, select them in the right box and click **Remove** to move it to the left box.
9. When you finish adding Ethernet ports, click the **Finish** button.

After you create LAGs, you can monitor their status from the LAG Port Info screen (see Section 6.14).

5.4.3.2 Modifying LAG Parameters

There may be times when you need to modify LAG parameters. Using the management console, you can view the Maximum Transmission Unit (MTU) size and requested speed. As you modify LAG parameters, record the information in Appendix B.

1. In the **Logical Resources** tab, click the LAG whose parameters you want to change.
2. Perform one of the following steps:
 - On the **Network** menu, click **Modify LAG Parameters**.
 - Right-click and click **Modify LAG Parameters**.

Either step displays the Modify LAG Parameters screen (see Figure 5-23).

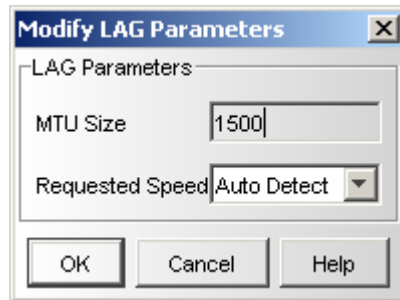

Figure 5-23 Modify Lag Parameters Dialog Box

3. Complete the fields in the screen (see Table 5-9).
4. Click **OK**.

Table 5-9 Modify LAG Parameters Screen Settings

Setting	Description
MTU Size	This value specifies the maximum size of a packet that can be transferred in one frame over a network.
Requested Speed	This value indicates the requested speed for transmitting and sending packets. For the DSN-3200, the choices are Auto Detect, 100 Mbps, and 10 Mbps. For the DSN-3400, the only choice is 10GB.

5.4.3.3 Adding or Deleting Physical Ports in a LAG

There may be times when you want to add physical ports to or delete physical ports from a LAG. The following steps describe this procedure. As you add or remove physical ports, record the information in Appendix B.

1. In the **Logical Resources** tab, click a LAG whose physical port you want to configure.
2. On the **Network** menu, click **Configure Physical Port**. The Add/Remove Ethernet Ports for LAG Wizard starts and the Add/Delete Ethernet Ports screen appears (see Figure 5-24).

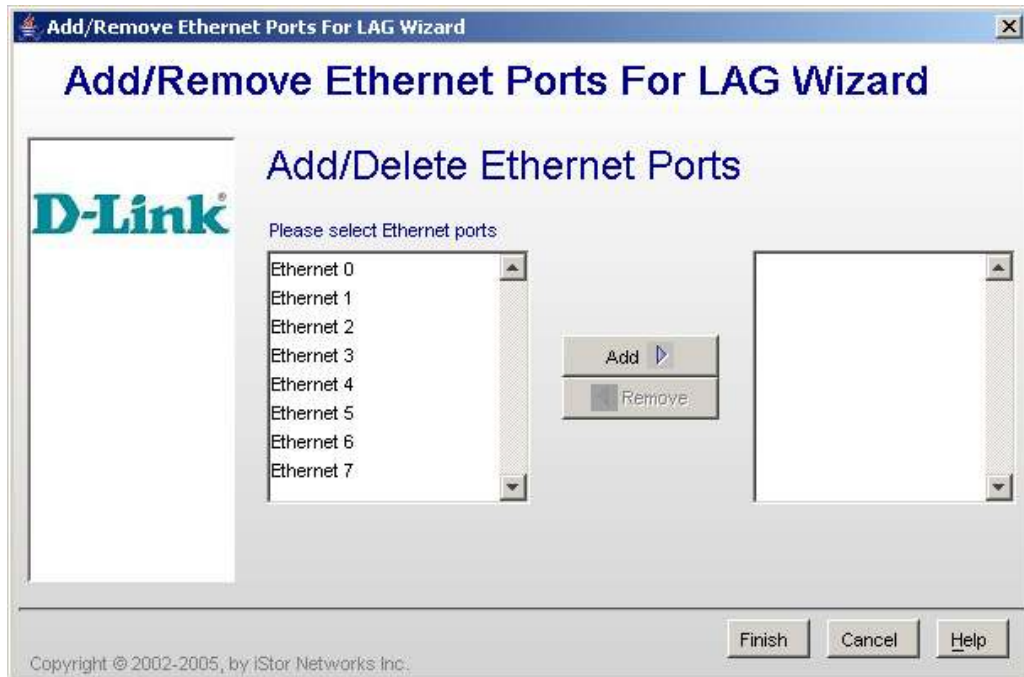

Figure 5-24 Add/Remove Ethernet Ports for LAG Wizard - Add/Delete Ethernet Ports screen

3. To add Ethernet ports, select one or more ports in the left box and click **Add** to move them to the right box.
4. To remove one or more Ethernet ports, select them in the right box and click **Remove** to move them to the left box.

When you finish adding Ethernet ports, click the **Finish** button.

5.4.3.4 Deleting LAGs

If you no longer need a LAG, use the following procedure to delete it.



A warning message does not appear before you delete a LAG. Therefore, be sure you do not need the LAG before you delete it.

1. In the **Logical Resources** tab, click the LAG you want to delete.
2. Perform one of the following steps to delete the selected LAG:
 - On the **Storage** menu, click **Delete LAG**.
 - Right-click and click **Delete LAG**.

5.4.4 Working with Network Portals

The network portal is the physical Ethernet port attached to the host. Before you create a network portal, you must assign an IP address for the network portal and an IP address for the iSCSI initiator (if more than one iSCSI initiator will access this network portal, each initiator needs its own IP address). The initiator(s) and the network portal must have different IP addresses, yet reside on the same subnet.

5.4.4.1 Creating Network Portals

The following procedure describes how to create network portals. When you create a network portal, you specify the IP address for each xStack Storage Array data port that will be communicating with your iSCSI initiator. As you create network portals, record the information in Appendix B.



Your iSCSI initiator(s) must be aware of the IP address(es) you specify in this procedure so it can communicate with the target xStack Storage Array.

1. In the **Logical Resources** tab, click the plus sign next to **Target Resources**.
2. Click the plus sign next to **Network Entities**.
3. Click the plus sign next to **LAG Resources**.
4. Under **LAG Resources**, click a LAG.
5. Perform one of the following steps:
 - On the **Network** menu, click **Create Network Portal**.
 - In the **Logical Resources** tab, right-click a LAG and click **Create Network Port**.

Either step starts the Create Network Portal Wizard and displays the Set the IP Address screen (see Figure 5-25).

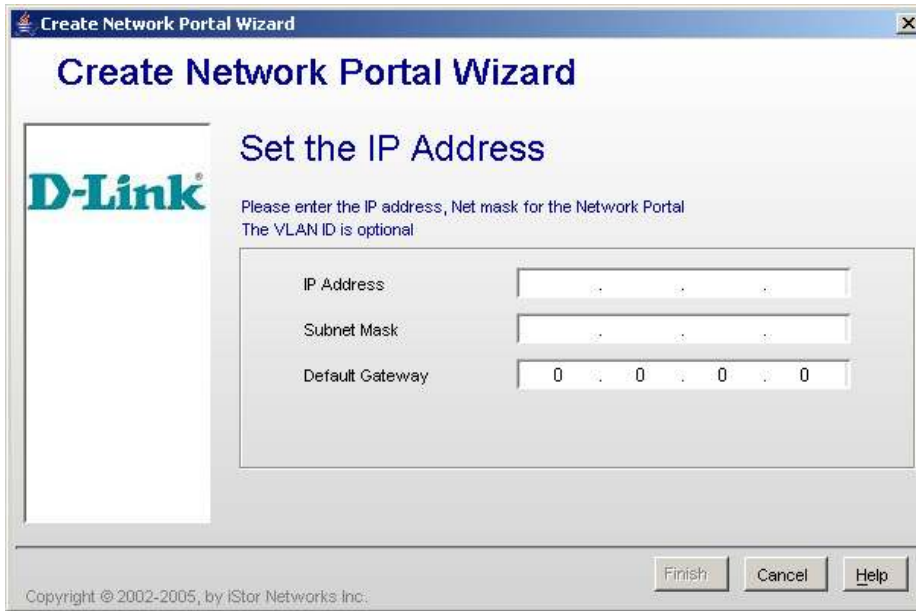

Figure 5-25 Create Network Portal Wizard – Set the IP Address Screen

3. Complete the fields in the screen (see Table 5-10).
4. Click the **Finish** button.
5. If more than one data port will be communicating with your iSCSI initiator, repeat this procedure for each data port, making sure to assign the appropriate IP address for each data port.



After you create the network portals, you can monitor their status using the Portals Information screen (see Section 6.15).

Table 5-10 Create Network Portal Wizard – Set the IP Address Screen Settings

Setting	Description
IP Address	Enter the IP address for the network portal. The IP address must be a unique address that is different than the management port and on the same subnet as the iSCSI initiator.
Subnet Mask	Enter a subnet mask for the network portal or press the Tab key to automatically accept the default subnet mask.
Default Gateway	If a router is required for the xStack Storage Array to reach the initiator(s), the default gateway must have the IP address of that router. In a network that requires a router between the xStack Storage Array and the initiator, enter the router's IP address. In a network that uses only direct connection, or a switch between the xStack Storage Array and the initiator(s), no entry is required.

5.4.4.2 Deleting Network Portals

If you no longer need a network portal, use the following procedure to delete it.



A warning message does not appear before you delete a network portal. Therefore, be sure you do not need the network portal before you delete it.

1. In the **Logical Resources** tab, click the network portal you want to delete.
2. Perform one of the following steps to delete the network portal:
 - On the **Network** menu, click **Delete Network Portal**.
 - Right-click and click **Delete Network Portal**.

5.4.5 Creating iSCSI Target Nodes

The iSCSI target node is the abstract entity used to permit access to the volumes on an xStack Storage Array by an initiator. The xStack Storage Array supports up to 1024 iSCSI target nodes. After you create one or more volumes, iSCSI initiators, and LAGs, you have all the prerequisites to create an iSCSI target node. As you create iSCSI target nodes, record the information in Appendix B.

To create an iSCSI target node, use the following procedure.

1. In the **Logical Resources** tab, click **Target Resources** or **Network Entities**.
2. Perform one of the following steps:
 - On the **iSCSI** menu, click **Create iSCSI Target Node**.
 - Right-click and click **Create iSCSI Target Node**.

Either step starts the Create iSCSI Node Wizard and displays the Enter iSCSI Node Information screen, which initially appears as in Figure 5-26.



Figure 5-26. Create iSCSI Node Wizard - Enter iSCSI Node Information Screen

3. Complete the fields in the screen (see Table 5-11).

Table 5-11 Create iSCSI Node Wizard - Enter iSCSI Node Information Screen Settings

Setting	Description
iSCSI Node Alias	An alias string can also be associated with an iSCSI node. The alias lets an organization associate a user-friendly string with the iSCSI name. This setting is optional.
Enable CHAP Secret	To use CHAP authentication to authenticate iSCSI connections, check this box to enable the CHAP secret. Then, in the CHAP Secret field, type the password that will be used by the xStack Storage Array to authenticate an initiator. This setting is optional. The CHAP secret is case sensitive. For security, each typed character in the CHAP secret appears as an asterisk (*). If you decide not to specify a CHAP secret now, you can do so in the future using the Set CHAP Secret command in the iSCSI menu.

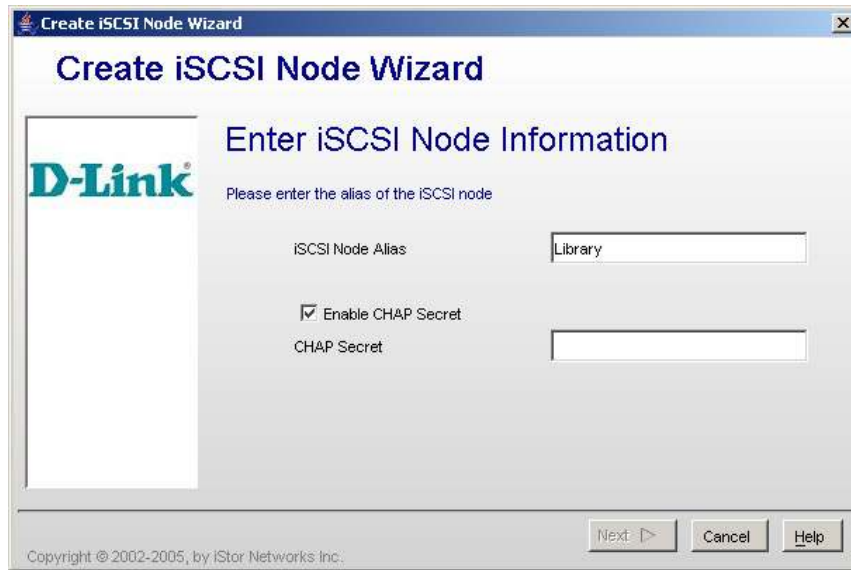

Figure 5-27. Create iSCSI Node Wizard - Enter iSCSI Node Information Screen with CHAP Secret Field Shown

4. Click **Next**. The Configure iSCSI Node Parameters screen appears (see Figure 5-28 and Figure 5-29).

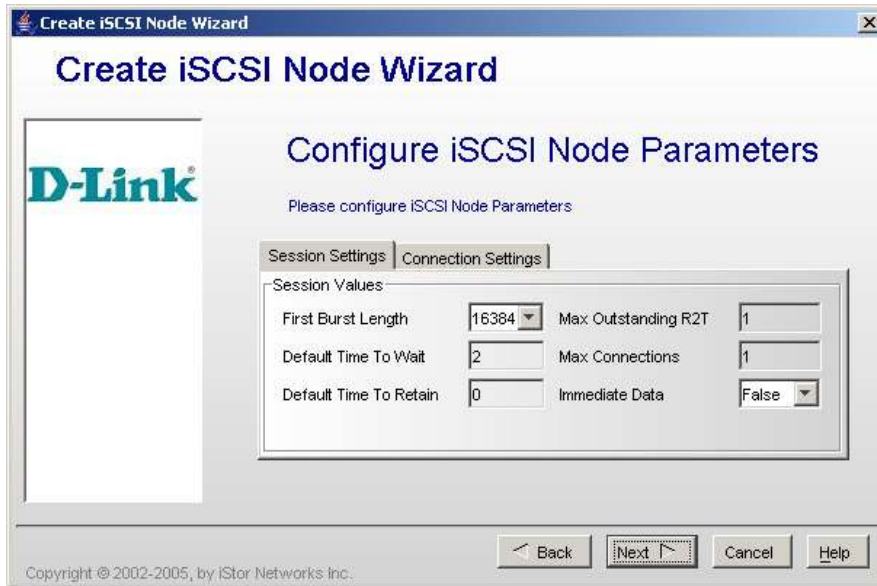

Figure 5-28. Create iSCSI Node Wizard - Configure iSCSI Node Parameters Screen (Session Settings Tab)

5. Accept the default settings in the **Session Settings** (see Figure 5-28) and **Connection Settings** tabs (see Figure 5-29).

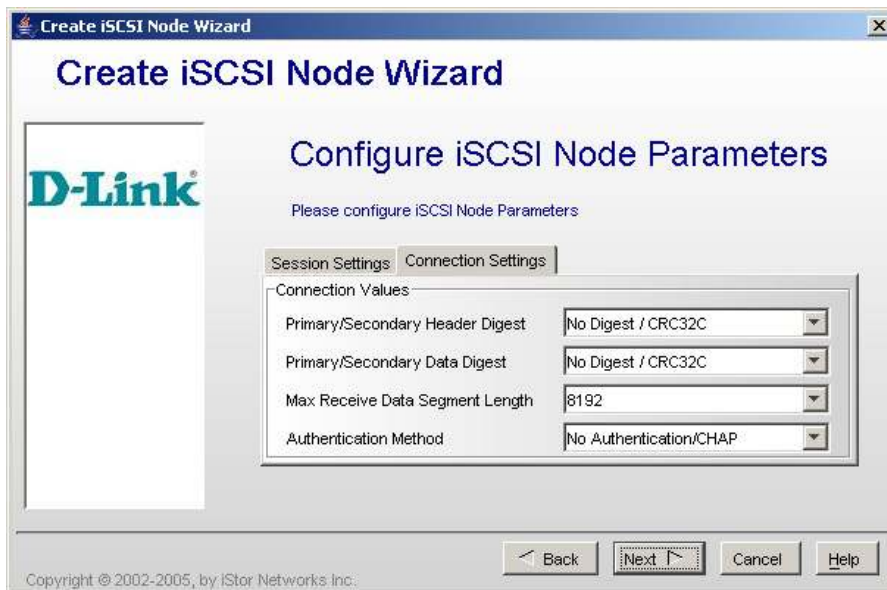

Figure 5-29. Create iSCSI Node Wizard - Configure iSCSI Node Parameters Screen (Connection Settings Tab)

6. Click **Next**. The Modify iSCSI Network Portal screen appears (see Figure 5-30).

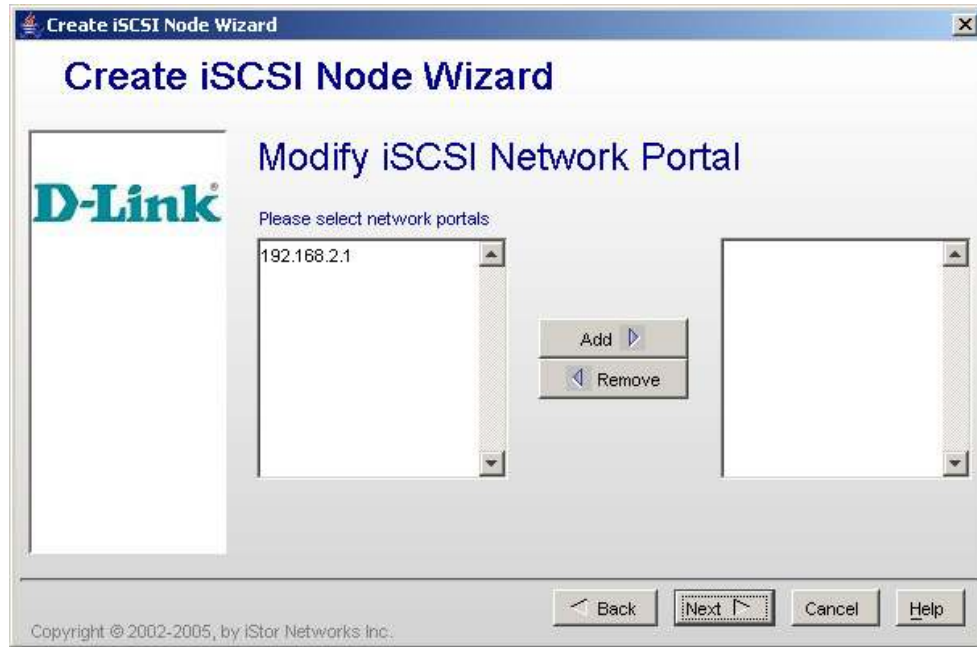

Figure 5-30. Create iSCSI Node Wizard – Modify iSCSI Network Portals Screen

7. In the left column, click the IP address of the network portal(s) allowed for this target node and click **Add** to move the IP address to the right list. To select additional IP addresses, repeat this step. (To remove an IP address from the right list, click it and click **Remove** to return the address to the left list.) When you finish, click **Next**. The Initiators List screen appears (see Figure 5-31).

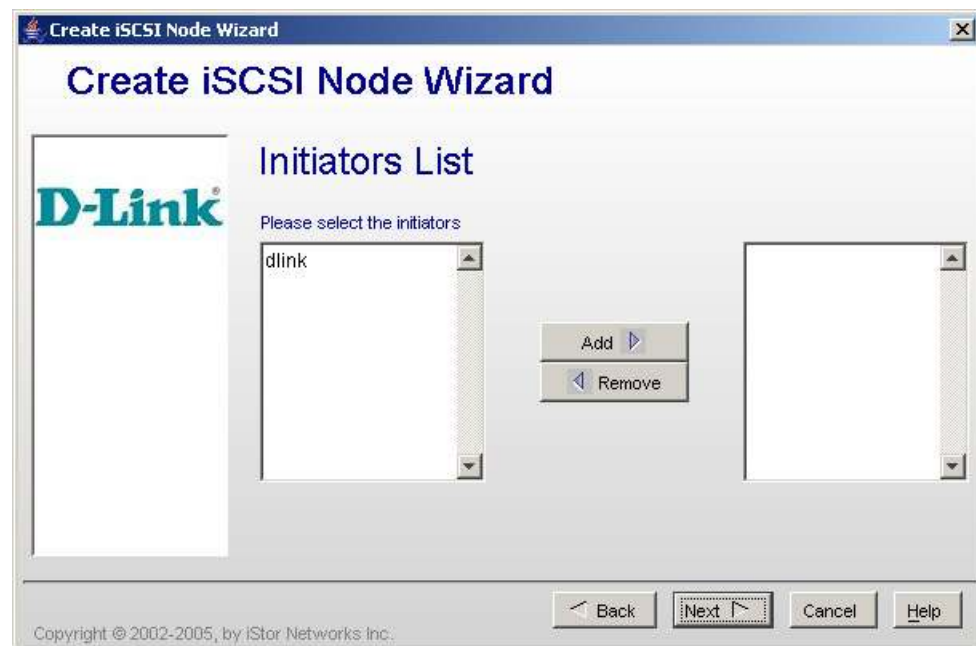

Figure 5-31. Create iSCSI Node Wizard – Initiator List Screen

8. The left box lists all the iSCSI initiators you have defined. Click the iSCSI initiator(s) in this list that are allowed to access the volumes through the target network portals whose IP addresses you selected in the previous screen.
9. Click Add to move the selected iSCSI initiator(s) to the right box.



If you want to remove an iSCSI initiator from the right box, click the iSCSI initiator in the right box and click **Remove** to return the iSCSI initiator to the left box.

10. Click **Next**. The Volume Access Right screen appears (see Figure 5-32).

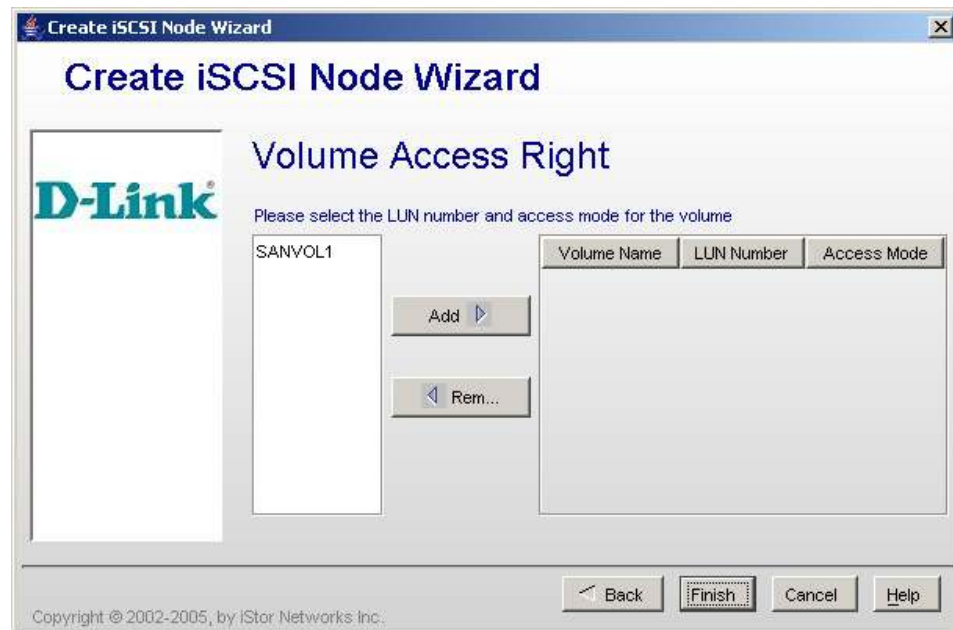

Figure 5-32. Create iSCSI Node Wizard – Volume Access Right Screen

11. The left box lists all the volumes you have created. Click a volume in this list, then click **Add** to move the selected volume to the right box. Note that all volumes currently can have only Read/Write access, which is the default.



You can select more than one volume in the left box:

- To select contiguous volumes, click the first one; then hold down the Shift key and click the last volume.
- To select noncontiguous volumes, click the first volume; then hold down the Ctrl key and click each additional volume you want to select.
- To deselect a volume, hold down the Ctrl key and click the volume.



To remove a volume from the right box, click the volume in the right box and click **Remove** to return the volume to the left box.

10. Click **Finish**. On completion, the xStack Storage Array assigns a world-wide unique name to the iSCSI target node. You can use the procedure in Section 6.11 to view the name and the other target node parameters.

5.4.5.1 Changing the CHAP Secret

When you created an iSCSI target node, you could specify an optional CHAP secret. If you did not, you can use the following procedure to specify one. You can also use this procedure to change the CHAP secret. Record the information in Appendix B.

1. Click a network entity (prefaced by **naa**) in the **Logical Resources** tab.
2. On the **iSCSI** menu, click **Change CHAP Secret**. The Set CHAP Secret dialog box appears (see Figure 5-33).

The image shows a Windows-style dialog box titled "Set CHAP Secret". The dialog box has a blue title bar with a close button (X) on the right. The main content area has the title "Set CHAP Secret" in a large blue font. Below the title is the instruction "Please enter the secret" in a smaller blue font. There are two text input fields: "CHAP Secret" and "Confirm CHAP Secret". At the bottom of the dialog box are three buttons: "OK", "Cancel", and "Help".

Figure 5-33. Set CHAP Secret Dialog Box

3. Complete the fields in the dialog box:
 - **CHAP Secret**. Enter the CHAP secret.
 - **Confirm CHAP Secret**. Enter the same CHAP secret.



The CHAP secret is case sensitive. For security, each typed character in **CHAP Secret** and **Confirm CHAP Secret** appears as an asterisk (*).

4. Click **OK**.

5.4.6 Logging on from the iSCSI Initiator Computer

For an iSCSI initiator node to access the volumes in a target node, it must log in to that target node. After you create a volume, an iSCSI initiator, a network portal, and iSCSI target nodes, you can log on to the xStack Storage Array from the iSCSI initiator computer. For example, using the DSN-3200:

1. Use an Ethernet RJ-45 cable to connect the appropriate xStack Storage Array Ethernet port to the NIC in the iSCSI initiator computer or to your Ethernet switch.
2. Configure the iSCSI initiator for use with the xStack Storage Array. This step varies according to the operating system used with the iSCSI initiator. For more information, please refer to the instructions for your iSCSI initiator software.
3. Use the initiator software to Log In to the xStack Storage Array. The software should confirm the log in with a response such as "Connected" and the initiator computer should be able to see the volumes on the xStack Storage Array.

The log in process is begun by the initiator when it sends a log in request packet which includes the world-wide unique name of the target node. The xStack Storage Array will accept the log in if all of the following conditions are met:

- The initiator's name is in the list of allowed initiators for that target node.
- The initiator connected to the xStack Storage Array using an xStack Storage Array IP address and port number in the list of allowed network portals for that target node.
- The CHAP secret (if CHAP is enabled) for the target node matches the one given by the initiator. In addition, if CHAP is enabled and the initiator was given a password (on the xStack Storage Array), the xStack Storage Array uses the CHAP protocol to validate that password with the initiator.

In addition, a set of configuration parameters are negotiated between the initiator and target during log in. A description of all the configuration parameters is beyond the scope of this document. For more information, refer to the iSCSI IETF specification.

5.4.7 Changing the iSCSI Port Number

The iSCSI port number is the TCP/IP port number on which the iSCSI target is listening. The standard port number for iSCSI is 3260, but some targets may allow the port number to be customized. The following procedure describes how to change the iSCSI port number.



Changing this parameter is not recommended.

1. Click the **xStack Storage** icon on the **Physical Resources** tab.
2. Perform one of the following steps:
 - On the **File** menu, click **Change iSCSI Port Number**.
 - Right-click and click **Change iSCSI Port Number**.

Either step displays the Modify iSCSI Port dialog box, with the current iSCSI port number shown (see Figure 5-34).

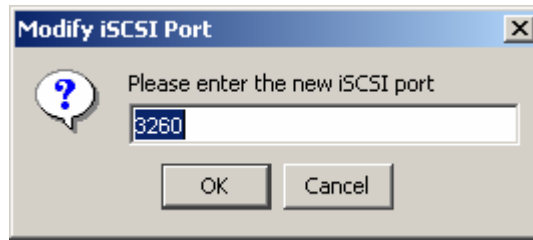

Figure 5-34 Modify iSCSI Port Dialog Box

2. Enter a new value for the iSCSI port.
3. Click **OK**. The new iSCSI port number will take effect after the next controller restart.

5.4.8 Setting the Default Task Priority

You can set the default task priority to specify whether background tasks receive a high or low priority. By default, the default task priority provides for minimum impact on the foreground applications performed by the xStack Storage Array. However, you can change this setting if desired. For example, you may want to specify a higher default task priority for time-critical tasks such as backups.



By changing the default task priority to a high priority, the xStack Storage Array will spend more resources performing tasks and fewer resources performing I/O for its initiators, potentially decreasing its performance (as observed from the initiators). If you want to change the priority of a single critical task, you can change the priority of that task without changing all tasks.

To set the default task priority, use the following procedure.

1. On the **File** menu, click **Set Default Task Priority**. The Set Default Task Priority dialog box appears, with the current setting shown (see Figure 5-35).

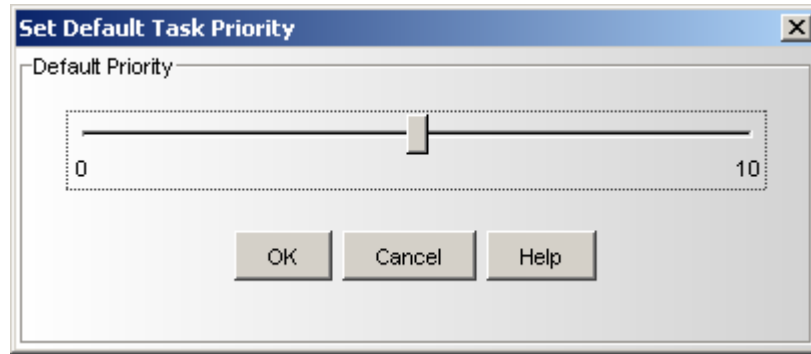

Figure 5-35 Set Default Task Priority Dialog Box

2. Use the slider switch to specify the default priority level (0 = highest priority, 10 = lowest priority).
3. Click OK.

5.4.9 Adding, Viewing, and Deleting IP Route Tables

Routing is the process of deciding the disposition of each incoming and outbound packet that the xStack Storage Array handles. Using the management console, you can view the xStack Storage Array's routing table. If a route being used encounters problems, you can use the management console to add route tables. Adding a route is also useful if you discover a quick alternative route to the destination. You can also use the management console to delete routes.

1. On the **View** menu, click **View Manual Route**. The View Route Table appears, with the current route tables shown (see Figure 5-36).

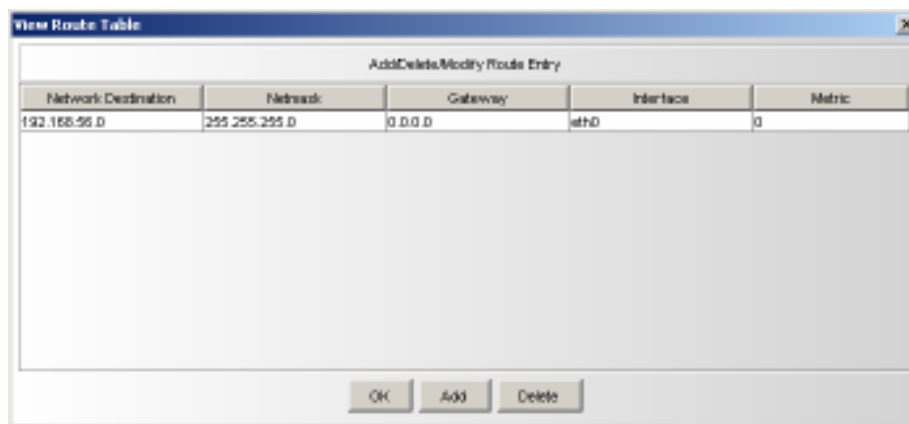

Figure 5-36. View Route Table

- To add a route to the routing table, click the **Add** button. Then, when the dialog box in Figure 5-37 appears, complete the fields and click **OK**. As you add route entries, record the information in Appendix B.

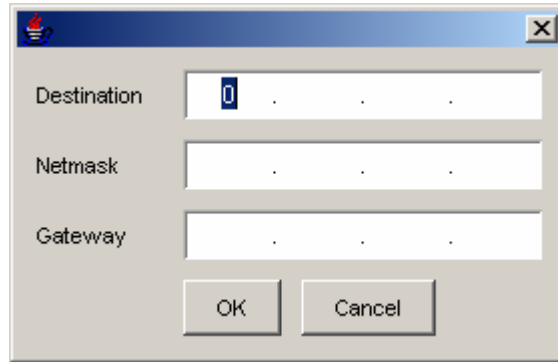

Figure 5-37. Adding a Route Table

- To delete a route, click the route in the View Route Table and click the **Delete** button.



A warning message does not appear before you delete a route. Therefore, be sure you do not need the route before you delete it.

Table 5-12 Route Table Settings

Setting	Description
Destination	Enter the IP address of the destination for this route.
Netmask	Enter the netmask (subnet mask) associated with the network destination or press the Tab key to automatically set the default subnet mask to 255 . 255 . 255 . 0. Because of the relationship between the destination and the subnet mask in defining routes, the destination cannot be more specific than its corresponding subnet mask. In other words, there cannot be a bit set to 1 in the destination if the corresponding bit in the subnet mask is a 0.
Gateway	Specifies the forwarding or next hop IP address over which the set of addresses defined by the network destination and subnet mask are reachable. For locally attached subnet routes, the gateway address is the IP address assigned to the interface that is attached to the subnet. For remote routes, available across one or more routers, the gateway address is a directly reachable IP address that is assigned to a neighboring router.
Metric	Specifies an integer cost metric (from 1 to 9999) for the route, which is used when choosing among multiple routes in the routing table that most closely match the destination address of a packet being forwarded. The route with the lowest metric is chosen. The metric can reflect the number of hops, the speed of the path, path reliability, path throughput, or administrative properties.

5.4.10 Modifying System TCP/IP Settings

You can use the management console to view and change the system's TCP/IP settings.

1. Click the **xStack Storage** icon on the **Physical Resources** tab.
2. Perform one of the following steps:
 - On the **File** menu, click **Modify System TCP/IP Settings**.
 - Right-click and click **Modify System TCP/IP Settings**.

Either step displays the Modify System TCP/IP Settings dialog box appears, with the current setting shown (see Figure 5-38).

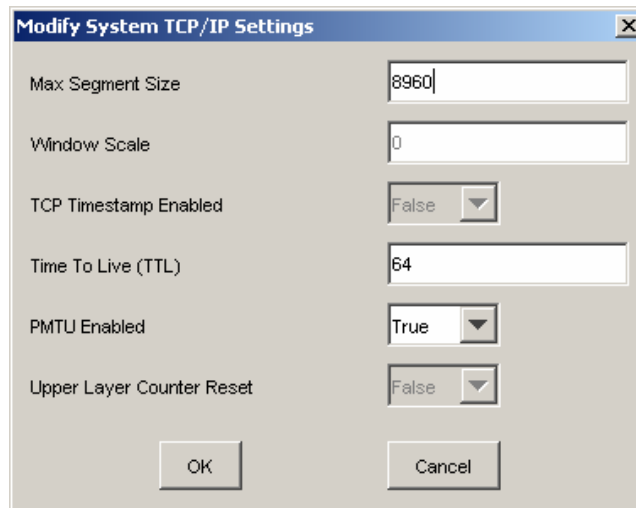

Figure 5-38. Modify System TCP/IP Settings Dialog Box

3. Complete the fields in the dialog box (see Table 5-13).
4. Click **OK**.

Table 5-13 Modify System TCP/IP Settings Dialog Box Settings

Setting	Description
Max Segment Size	Indicates the maximum size TCP segment that can be accepted on a TCP/IP connection when the connection is established.
Window Scale	Lets you use large windows during TCP/IP connections. On fast, high-bandwidth networks, a large TCP window provides greater efficiency by allowing for a greater amount of unacknowledged data.
TCP Timestamp Enabled	Causes the receiving computer to send a time-stamp reply back to the originating computer. Systems can use time-stamp requests and replies to measure the transmission speed of datagrams on a network.
Time to Live (TTL)	Specifies the default time to live (TTL) value for IP packets generated by the Windows TCP/IP stack.
PMTU Enabled	Lets the xStack Storage Array automatically adapt its packet size. Disabling this option forces the system to keep its default packet size (576 bytes), even when it receives an ICMP request to change its packet size; this can render some remote systems unreachable, because if intermediate systems on the path to the remote system cannot support the default packet size, the xStack Storage Array ignores their requests to make the packets smaller.
Upper Layer Count Reset	Resets the TCP/IP upper layer counters. Resetting the counters simplifies the ability to look at the counters for an accurate percentage of packets sent or received.

5.4.11 Setting the Spare Count

A spare is a drive that is present in the system (in the **Available Pool**) that cannot be used for any reason, except to rebuild space used by a volume on a failed drive. If a drive fails, the xStack Storage Array tries to find a replacement extent for every extent on that failed drive that was part of a redundant volume. First, a replacement extent is sought on a drive in the volume's pool (currently, the **Blade A Base Pool**). If space is not found in that pool and a drive exists in the **Available Pool**, one drive is obtained from the **Available Pool** and an extent is selected from that drive. In either case, a rebuild task starts to rebuild the volume's extent. If the available pool is empty, some volumes may not be rebuilt. The spare count exists to reduce that likelihood.

The spare count default is 0, which means that no drives are kept in reserve for use in rebuilding extents (i.e., all drives can be obtained from the **Available Pool** for any purpose). Automatic Volume Creation, for example, takes drives from the **Available Pool** automatically as needed to satisfy the parameters in the request. If the spare count is set to a non-zero value, that number of drives is retained in the **Available Pool** for use only for rebuilds (i.e., operations other than rebuild cannot take a drive from the **Available Pool** if taking that drive results in the **Available Pool** having fewer drives than the spare count value). For example, assume that the spare count is one in an enclosure with 12 drives installed. If the administrator tried to perform an Automatic Volume Creation with both sliders at 10 (their maximum values), the volume is created using 11 drives, without touching the twelfth. If a drive fails, the twelfth drive moves automatically from the **Available Pool** to the volume's pool, so its space can be used to rebuild the original failed extent.

1. Click the **xStack Storage** icon on the **Physical Resources** tab.
2. Perform one of the following steps:
 - On the **File** menu, click **Set Spare Count**.

- Right-click and click **Set Spare Count**.

Either step displays the Set Spare Count dialog box, with the current setting shown (see Figure 5-39).

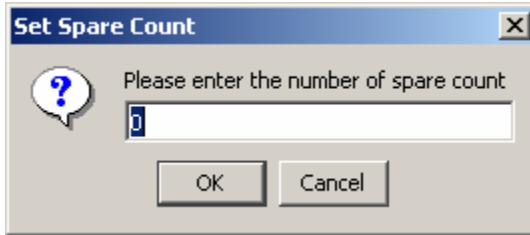

Figure 5-39. Set Spare Count Dialog Box

Enter a value that corresponds to the number of drives and click **OK**.

5.4.12 Using the Down Drive Feature

The xStack Storage Array provides a Down Drive feature that allows a drive to be removed from the system in an orderly way. Using this feature, you can, for example, replace a smaller drive with a larger drive, or replace a drive for which S.M.A.R.T. has projected a failure. The xStack Storage Array can perform up to five concurrent Down Drive operations at one time.

The Down Drive operation requires all space used on the drive to be relocated onto different drives. The Down Drive feature handles this requirement by performing a reconfigure task on every volume that uses space on the drive. This operation is conducted for any type of volume, including redundant and non-redundant organizations.

When all space has been moved off the drive, the drive is moved to the **Unusable Pool** and can be removed from the system.

5.4.12.1 Initiating the Down Drive Operation

To use the Down Drive feature, right-click the drive you want to remove and click **Down Drive**. The Down Drive task appears in the task pane of the xStack Storage Array management console. One reconfigure task is created automatically for each volume that used space on the selected drive. The reconfigure tasks are issued one at a time. The progress of the Reconfigure and Down Drive tasks can be monitored on the task pane.

5.4.12.2 Suspending and Resuming the Down Drive Operation

To suspend the Down Drive operation:

1. Select the Down Drive task.
2. Right-click and select the **Suspend** option.

To resume the Down Drive operation, right click and select the **Resume** option.

When a Down Drive operation is suspended or resumed, any reconfigure task controlled by that Down Drive operation automatically changes state to Suspend or Restore, respectively. Do not try to suspend or resume the reconfigure task directly; always change the Down Drive task.

5.4.13 Using the xStack Storage Array's iSNS Features

Internet Storage Naming Service (iSNS) facilitates the automated discovery, management, and configuration of iSCSI and Fibre Channel devices on a TCP/IP network. iSNS provides intelligent storage discovery and management services comparable to those found in Fibre Channel networks, allowing a standard IP network to operate in much the same way that a Fibre Channel SAN does. Because iSNS can emulate Fibre Channel fabric services and manage both iSCSI and Fibre Channel devices, an iSNS server can be used as a consolidated configuration point for an entire storage network.

The xStack Storage Array management console supports two iSNS configuration options:

- The xStack Storage Array management console can use an iSNS server to discover all registered iSCSI Initiators and add them into the xStack Storage Array internal CIM database.

The xStack Storage Array can register itself for discovery by the iSNS server.

5.4.13.1 Discovering All Registered iSCSI Initiators

To discover all registered iSCSI initiators, use the following procedure.

1. On the **File** menu, click **Configure iSNS Client**. The iSNSClient dialog box appears (see Figure 5-40).

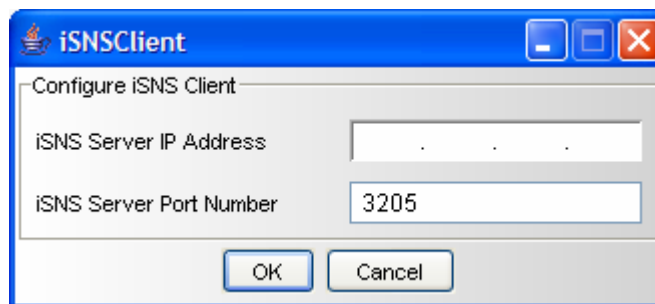

Figure 5-40. iSNS Client Dialog Box

2. Complete the fields in the **Configure iSNS Client** area (see Table 5-14).
3. Click **OK**. The xStack Storage Array CIM database is updated with all the available initiators registered with the server. To view the initiators, go to the **Logical Resources** tab under **Initiator Resources**.

Table 5-14. iSNSClient Dialog Box

Setting	Description
iSNS Server IP Address	Enter the IP address of the iSNS server.
iSNS Server Port Number	Enter the port number on which the iSNS server is communicating. The default port number is 3205.

5.4.13.2 Registering the xStack Storage Array with an iSNS Server

To register the xStack Storage Array with an iSNS server, use the following procedure.

1. On the **File** menu, click **Configure System iSNS**. The Configure System iSNS dialog box appears (see Figure 5-41).

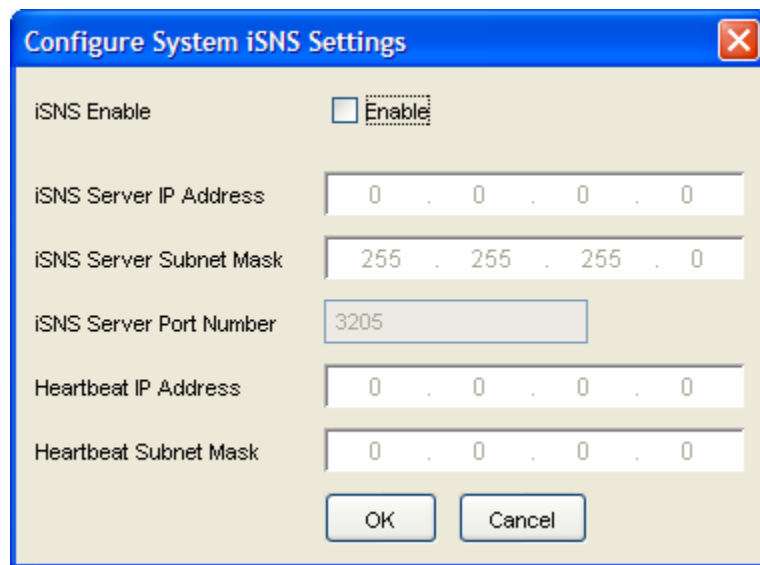

Figure 5-41. Configure System iSNS Dialog Box

4. Complete the fields in the dialog box (see Table 5-15).
5. Click **OK**. The settings are saved and the xStack Storage Array registers itself with the iSNS server.

Table 5-15. Configure System iSNS Settings Box

Setting	Description
iSNS Enable	Check this box to enable the other settings in the dialog box. If this box is not checked, the other settings in this dialog box are ignored.
iSNS Server IP Address	Enter the IP address of the server running the iSNS service.
iSNS Server Subnet Mask	Enter the subnet mask of the server running the iSNS service.
iSNS Server Port Number	Enter the port number on which the server running the iSNS service is listening. The default port number is 3205.
Heartbeat IP Address	Enter the IP address from which the iSNS heartbeat originates. Typically, this address is the same as the iSNS server IP address, though it may be different.
Heartbeat Subnet Mask	Enter the subnet mask from which the iSNS heartbeat originates. Typically, this subnet mask is the same as the iSNS server subnet mask, though it may be different.

5.4.14 Creating Scheduled Tasks

You can use the management console to set up tasks you want the xStack Storage Array to perform, such as parity or media scans. When you create a task, you specify the day and time when it is to be performed and whether the task will repeat (recur). As you create scheduled tasks, record the information in Appendix B.

1. On the **View** menu, click **Create Task**. The Scheduled Task Wizard launches and the Volume and Operation screen appears (see Figure 5-42).

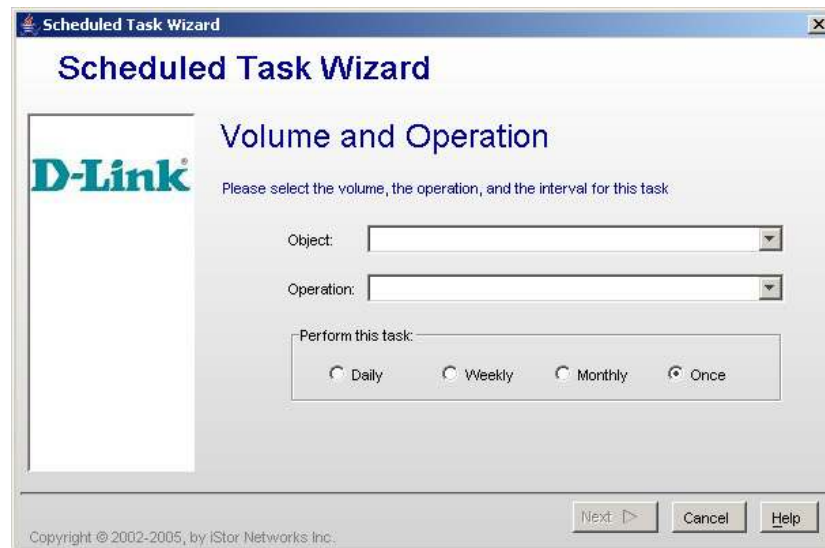

Figure 5-42 Scheduled Task Wizard – Volume and Operation

2. Complete the fields in the screen (see Table 5-16).
3. Click **Next**. The Select Date and Time screen appears (see Figure 5-43).



Figure 5-43. Scheduled Task Wizard – Select Date and Time Screen

4. Complete the fields in the screen (see Table 5-17).
5. Click Finish.

After scheduling tasks, you can view their status from the Tasks Info screen (see Chapter 6).

Table 5-16 Scheduled Task Wizard – Volume and Operation Screen Settings

Setting	Description
Object	Select the volume on which the scheduled task will be performed.
Operation	Select the task that is to be performed.
Perform this Task	Select how often the scheduled task is to be performed.

Table 5-17 Scheduled Task Wizard – Select Date and Time Screen Settings

Setting	Description
Start Time	Use the controls to specify the time when the scheduled task is to start.
Start Date	Use the calendar to select the date when the scheduled task is to start. You can use the controls below the calendar to move to the previous year, previous month, next month, or next year.

5.4.15 Setting the System Battery Policy

If your xStack Storage Array has an onboard battery, the system battery policy defines how contents in cache memory are handled if the battery is not fully charged. By default, the xStack Storage Array is configured to buffer all I/O in cache memory. You can, however, change this setting to protect data against situations when the battery is not fully charged.

1. Click the **xStack Storage** icon on the **Physical Resources** tab.
2. Perform one of the following steps:
 - On the **File** menu, click **Set System Battery Policy**.
 - Right-click and click **Set System Battery Policy**.

Either step displays the Battery Policy dialog box appears, with the current setting shown (see Figure 5-44). The icon at the top of the dialog box provides a color-coded indication of the xStack Storage Array battery status.

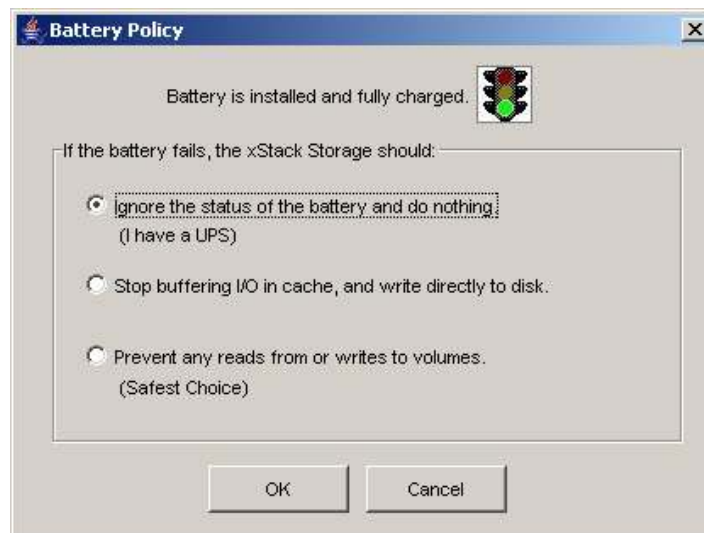

Figure 5-44. Battery Policy Dialog Box

3. Select the appropriate setting that the xStack Storage Array should whenever the battery is not fully charged (see Table 5-18).
4. Click **OK**.

Table 5-18 Battery Policy Settings

Setting	Description
Ignore the status of the battery and do nothing	No action is taken to protect the contents of cache data in the event of an uncharged battery. If the xStack Storage Array loses AC power, its onboard battery will be used to protect the contents of cache memory (up to 72 hours for a fully charged battery).
Stop buffering I/O in cache, and directly write data to disk	I/O buffered in cache memory is written to disk whenever the xStack Storage Array battery is not fully charged.
Prevent any reads from or writes to volumes	Stops all read and write operations whenever the battery is not fully charged.



The xStack Storage Array battery is designed to provide backup power in the event of a power failure. If a power failure occurs, a fully charged battery will protect the contents of buffer memory for 72 hours.

5.4.16 Saving the Event Log

The event log tracks the xStack Storage Array informational, warning, and error messages (see Section 6.2). Using the management console, you can save the event log as an unformatted text file to a user-specified folder.

1. Be sure the **Physical Resources** tab is the active tab and select the **Log Messages** tab.
2. Scroll the page down to make sure that all messages you want to save can be viewed.
3. On the **View** menu, click **Save Event Log Messages**. The Open dialog box appears (see Figure 5-45).

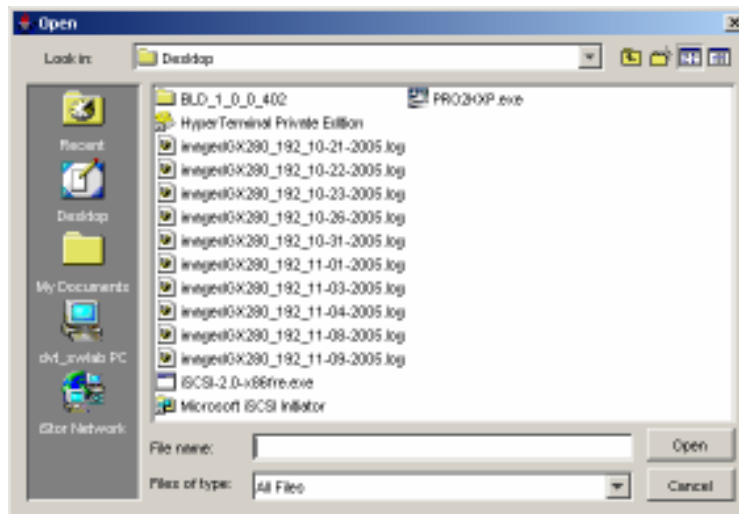

Figure 5-45. Open Dialog Box

4. Using the Open dialog box, navigate to the location where you want the event log text file to reside.
5. In the **File name** field, enter a name for the event log text file.
6. Click **OK**.

5.5 Changing Initial Configuration Settings

When you started the xStack Storage Array for the first time, you specified the unit's initial settings using the OOBE setup wizard. You may need to change these settings in the future. For example, you may need to change the date and time if time changes occur in your area.

The following sections describe how to change the settings you specified during the OOBE setup wizard.

5.5.1 Changing the Out-of-Band Port Configuration

You specified the management interface settings in the OOBE setup wizard when you started the xStack Storage Array for the first time. If you need to change these settings, perform the following procedure:

1. Click the **xStack Storage** icon on the **Physical Resources** tab.
2. Perform one of the following steps:
 - On the **File** menu, click **Configure Out of Band Port**.
 - Right-click and click **Configure Out of Band Port**.

Either step displays the Configure Out of Band Port dialog box (see Figure 5-46).

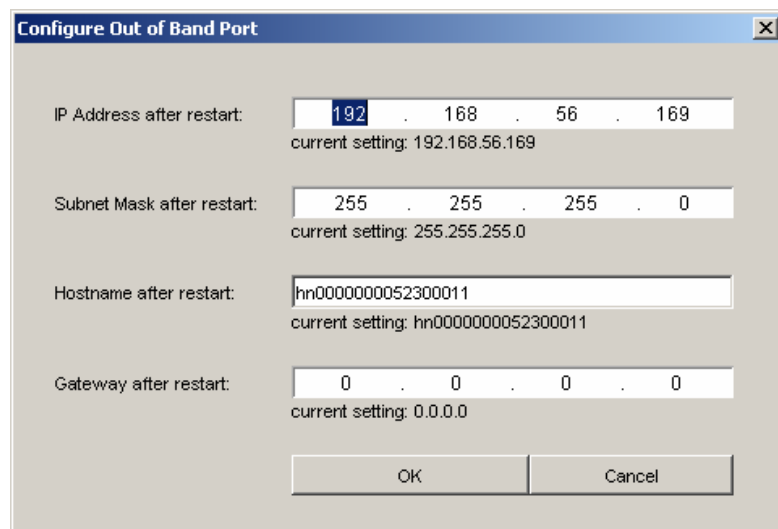

Figure 5-46 Configure Out of Band Port Dialog Box

3. Complete the fields in the dialog box (see Table 5-19).



For convenience, the current settings appear below each field. Remember the new IP address; you will need it for subsequent logins to the console. We recommend that you record the IP address in Appendix B.

4. On the **File** menu, click **Restart**. When the confirmation prompt “Do you want to restart the system?” appears, click **Yes**.

5. After the xStack Storage Array has become ready and reboot is complete, launch the browser, enter the new IP address, and click **Go** on the browser. The Login Screen initializes and the username and password must be re-entered.



If the Login Screen does not appear, be sure you entered the new IP address in your browser. If you changed the subnet for the xStack Storage Array, be sure you configured the NIC in the management PC to use that subnet.

Table 5-19. Configure Out of Band Port Dialog Box Settings

Setting	Description
IP address after restart	Enter an available IP address that will take effect after the xStack Storage Array restarts. Write the new IP address on paper for reference purposes.
Subnet Mask after restart	Enter the subnet mask that will take effect after the xStack Storage Array restarts. Configure the NIC in the management PC to use the same subnet.
Host name after restart	The xStack Storage Array is assigned a default host name. If desired, you can change this name to one that is meaningful to you.
Gateway after restart	Enter the gateway that will take effect after the xStack Storage Array restarts.

5.5.2 Changing the System Date and Time

You specified the system date and time settings in the OOBE setup wizard when you started the xStack Storage Array for the first time. If you need to change these settings, perform the following procedure:

1. Click the **xStack Storage** icon on the Physical Resources tab.
2. Perform one of the following steps:
 - On the **File** menu, click **xStack Storage Date and Time**.
 - Right-click and click **xStack Storage Date and Time**.

Either step displays the xStack Storage Date and Time dialog box (see Figure 5-47).

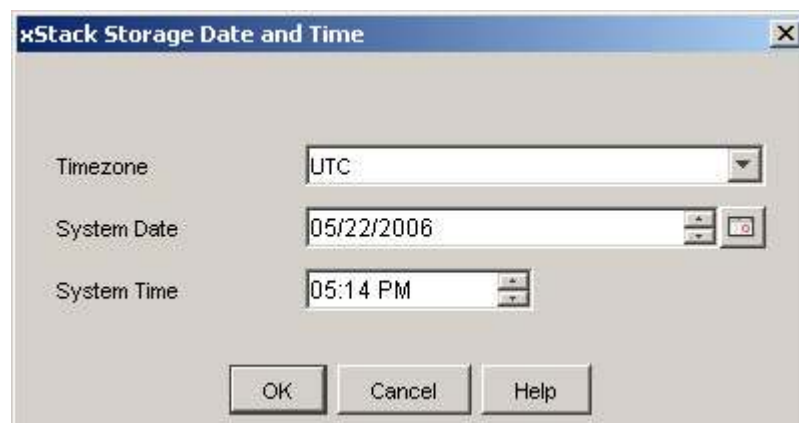

Figure 5-47 xStack Storage Date and Time Dialog Box

3. Complete the fields in the dialog box (see Table 5-20).
4. Click **OK**.
5. Restart the xStack Storage Array for the new settings to take effect.

Table 5-20. xStack Storage Date and Time Dialog Box Settings

Setting	Description
Timezone	Select the appropriate timezone from the drop-down list.
System Date	Use the controls to the right of this field to select the appropriate system date or click the calendar icon and select a date from the popup calendar.
System Time	Use the controls to the right of this field to select the appropriate system time.

5.5.3 Changing Email Notification Setup

You may have specified email notification settings in the OOB setup wizard when you started the xStack Storage Array for the first time. If you need to change these settings, or if you want to enable or disable this feature now, perform the following procedure:

1. Click the **xStack Storage** icon on the **Physical Resources** tab.
2. On the **File** menu, click **Configure Email Notification**. The Configure Email Notification dialog box appears (see Figure 5-48).

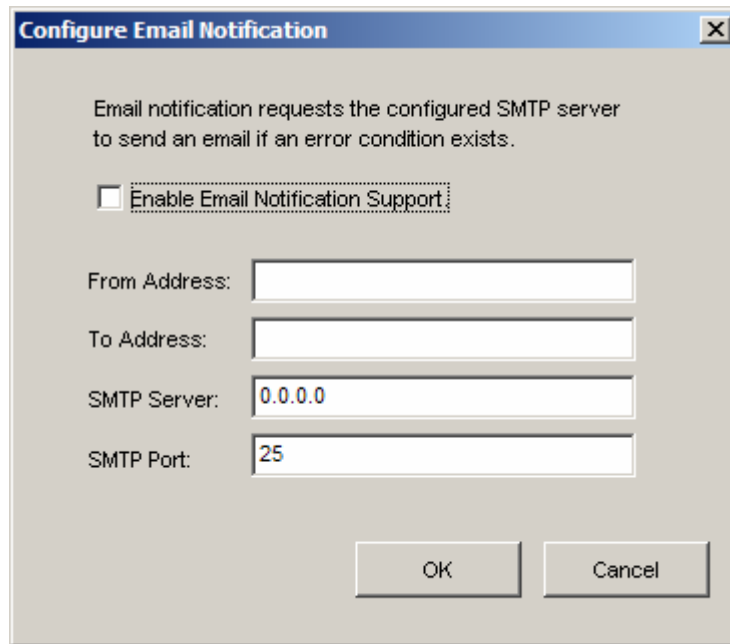

Figure 5-48 Configure Email Notification Dialog Box

3. Complete the fields in the dialog box (see Table 5-21).
4. Click **OK**.

Table 5-21. Configure Email Notification Dialog Box Settings

Setting	Description
Enable Email Notification Support	Click this option to enable email notifications from the xStack Storage Array.
From Address	Enter the email address of a user. Each email sent by the xStack Storage Array will be identified as being sent from this user.
To Address	Enter the email address where notifications are to be sent. This can be an individual email address or a distribution list.
SMTP Server	Enter the IP address of the mail server through which email notifications from the xStack Storage Array will be routed.
SMTP Port	Enter the SMTP port on which the mail server will be listening for email alerts from the xStack Storage Array (default is 25).

5.6 Managing xStack Storage Array Configurations

The management console provides options for saving and restoring the xStack Storage Array configuration. You can also return the xStack Storage Array to its factory-default settings.

5.6.1 Saving the xStack Storage Array Configuration

To save the current xStack Storage Array configuration, use the following procedure.

1. On the **File** menu, click **Save xStack Storage Configuration**. The Save xStack Storage Configuration dialog box appears (see Figure 5-49).

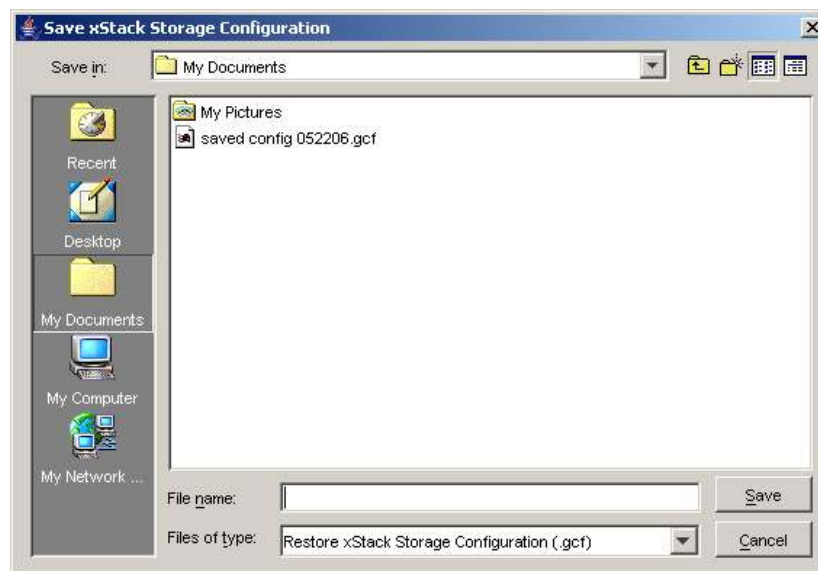

Figure 5-49 Save xStack Storage Dialog Box

2. Navigate to the location where you want to save the configuration.
3. In the **File name** field, type a name for the configuration.
4. Click the **Save** button.

5.6.2 Restoring the xStack Storage Array Configuration

If you used the procedure in Section 5.6.1 to save the xStack Storage Array configuration, you can use the following procedure to restore the saved configuration.

1. On the **File** menu, click **Restore xStack Storage Configuration**. The Restore xStack Storage Configuration dialog box appears (see Figure 5-50).

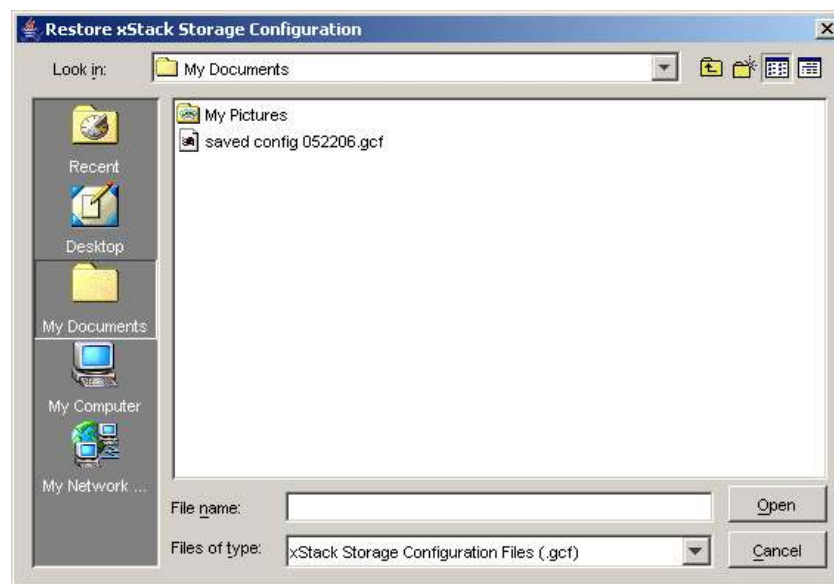

Figure 5-50. Restore xStack Storage Configuration Dialog Box

2. Locate the configuration file whose settings you want to load, then select the file and click the **Open** button. The message in Figure 5-51 appears.

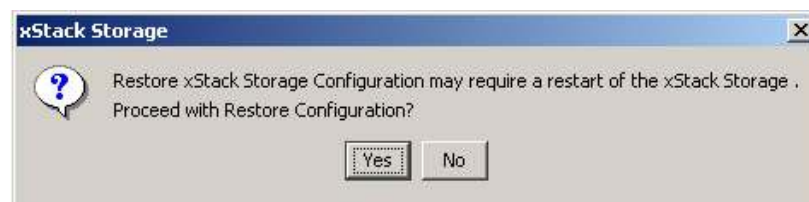

Figure 5-51. Configuration Restore Message

3. Click **Yes** to restore the configuration. (Or click **No** to keep the current configuration.) If you clicked **Yes** the xStack Storage Array restarts and loads the selected configuration.

5.6.3 Restoring Factory Defaults

To return the xStack Storage Array to its factory-default settings, use the following procedure.



For firmware 1.4.0.27 and later, when you return to the factory-default settings, you are given the choice to return the management port to its default address of 192.168.1.1 or keep the address already specified.

1. On the **File** menu, click **Restore Factory Defaults**. A message tells you that you may have to restart the xStack Storage Array and asks whether you want to proceed..
2. Click **Yes** to restore the factory-default settings. (Or click **No** to keep the current configuration.)
3. If you clicked **Yes**, another dialog box asks whether you want to keep the current management port configuration settings. Click **Yes** to keep them and proceed, **No** to revert to the default management port settings and proceed, or click **Cancel** to cancel the operation.
4. If you clicked **Yes** or **No**, the xStack Storage Array loads the factory-default settings (and those for the management port if you clicked **Yes**) and displays the message to let you know that restore to factory defaults was successful.
5. Click **OK** to restart the xStack Storage Array with the factory-default settings. When the xStack Storage Array restarts, the first attempt to log in with a Web browser will run the Out-of-Box Experience setup wizard (see Chapter 4).

5.7 Restarting the xStack Storage Array

To restart the xStack Storage Array, use the following procedure.

1. Log off from all iSCSI initiators.
2. Click the **xStack Storage** icon on the **Physical Resources** tab.
3. Perform one of the following steps:
 - On the **File** menu, click **Restart System**.
 - Right-click and click **Restart System**.

Either step displays a message that asks whether you are sure you want to restart the system.

4. Click **Yes** to restart the system (or click **No** to keep the system running). If you clicked **Yes**, your management console session ends and the xStack Storage Array is restarted. You can then use the log in procedure earlier in this chapter to log into the management console.

5.8 Shutting Down the Management Console

To shut down the management console, use the following procedure.

1. Click the **Physical Resources** tab.
2. Perform one of the following steps:
 - On the **File** menu, click **Exit**.
 - Click the Close control on the title bar.

5.9 Shutting Down the xStack Storage Array

At the end of your session, use the following procedure to shut down the management console. When you shut down the xStack Storage Array, it powers off automatically.



The following steps are the proper procedure for shutting down the xStack Storage Array. Failing to use this procedure to shut down the xStack Storage Array will result in battery power degradation if a UPS is not used.

1. Log off from all initiators.
2. Click the **xStack Storage** icon on the **Physical Resources** tab.
3. Perform one of the following steps:
 - On the **File** menu, click **System Shutdown**.
 - Right-click and click **Shutdown System**.

Either step displays a message that asks whether you are sure you want to shut down the system.

Click **Yes** to shut down the system (or click **No** to keep the system running). If you clicked **Yes**, your management console session ends and the xStack Storage Array is powered off.

Chapter 6 Monitoring the xStack Storage

This chapter describes the management console screens that appear in the main area for viewing system and storage information. Some screens are available from either the **Logical Resources** or **Physical Resources** tab. Other screens are available from both tabs. Use Table 6-1 to find the screen that contains the information you want to view.

Table 6-1 xStack Storage Array Screens

For Information About...	Use This Screen	See Section
Drives in the Blade A Base Pool or on the Physical Resources tab	Drive Information screen	6.10
Ethernet ports in the Physical Resources tab	Ethernet Port Information screen	6.19
Connection parameters and session information for a selected connection	Connection Information screen	6.16
Event log messages	Log Messages screen	6.2
Firmware image	Firmware Image Info screen	6.5
xStack Storage enclosure	Enclosure Information screen	6.1
xStack Storage tasks	Tasks Info screen	6.7
IP addresses and port numbers for a selected network entity	Portals Info screen	6.15
iSCSI initiators	Initiator Information screen	6.17
iSCSI initiators and access for a selected network entity	Initiator Access Info screen	6.13
LAG ports	LAG Port Info screen	6.14
LUN mapping for a selected iSCSI initiator	LUN Map Information screen	6.18
LUN mapping for a volume on a selected network entity	Volume Access Info screen	6.12
Session and connection parameters for a selected network entity	Target Node Info screen	6.11
SMART attributes	SMART Attributes	6.10.2
SMART data	SMART Data screen	6.10.2
Storage Management Initiative (SMI) server and profile	Server SMI Information screen	6.4
Storage pools parameters	Storage Group Information screen	6.6
Tasks assigned to storage pools	Tasks Info screen	6.7
Tasks assigned to volumes	Task Info screen to view tasks	6.9
Volume information	Volume Information screen	6.8

6.1 Viewing Enclosure Information

When the **xStack Storage** icon is selected in the **Physical Resources** tab, you can use the Enclosure Information screen to view information about the xStack Storage Array enclosure (see Figure 6-1). This screen is divided into three areas:

- **Message Log Summary.** The Message Log Summary summarizes the current error, warning, and information messages in the event log. To enhance visibility, the three message types are color coded.
 - Error messages are red and indicate something unexpected has occurred that may be a serious problem.
 - Warning messages are yellow. Warning messages indicate that something appeared wrong but has been corrected. They also provide notification about things that may be expected but are of particular interest.
 - Informational messages are green. Informational messages contain information about steps performed, detected version information, and miscellaneous messages.

For more information about a message, go to the Log Messages screen (see Section 6.2).



If your xStack Storage Array supports Enclosure Services and an error occurs, email notification is sent, the Fault/Ready LED illuminates red (chassis support required) and the Message Event Log identifies an error. If the temperature exceeds the overheat temperature limit, the xStack Storage Array shuts down automatically.

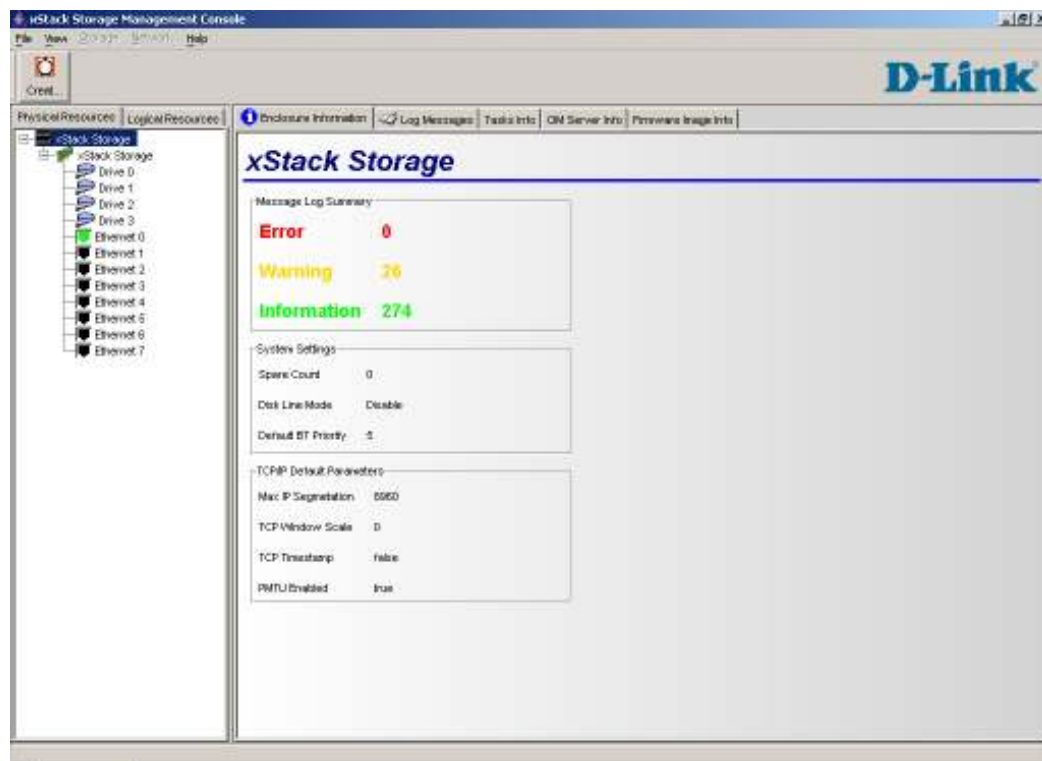

Figure 6-1 Enclosure Information Screen

6.2 Viewing Log Messages

When the **xStack Storage** icon is selected in the **Physical Resources** tab, you can use the Log Messages screen to view the entries in the event log (see Figure 6-2).

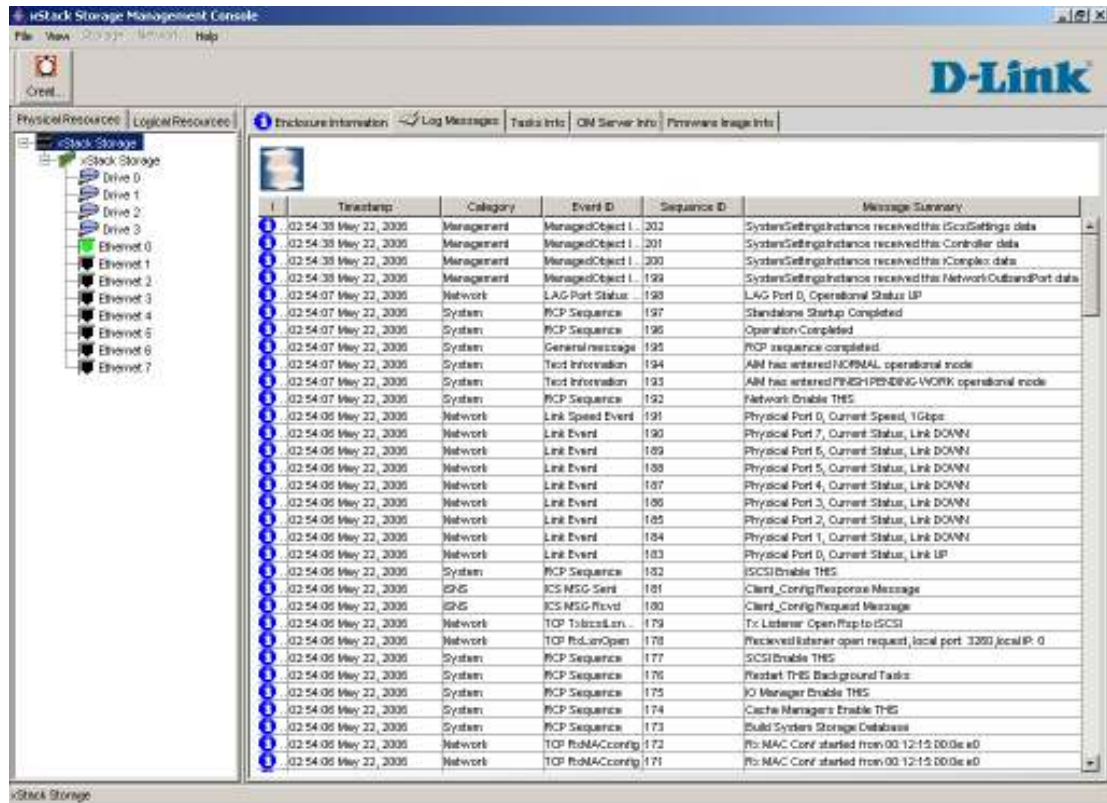



Figure 6-2 Log Messages Screen

The messages are color coded, making it easy to differentiate among informational, warning, and error messages. The messages are time- and date-stamped, with the most recent entry appearing at the top of the screen.

Log messages fall into one of three categories:

- Informational messages convey information of interest. The following is an example of an informational message:

	12:47:32 May 10, 2006	System	General mess... 9119	1 - Processing: Initialize signals
---	-----------------------	--------	----------------------	------------------------------------

- Cautionary messages indicate a minor problem that should not impede the use of the resource. The following is an example of a cautionary message:

	12:45:50 May 10, 2006	System	General mess... 9096	Select failed on MMSG.
---	-----------------------	--------	----------------------	------------------------

- Alarm messages indicate that a severe condition exists that could potentially cause a problem with resources. The following is an example of an alarm message:

	12:46:02 May 10, 2006	System	General mess... 9107	Error occurred running '/sbin/rmmod ichar'
---	-----------------------	--------	----------------------	--

To obtain additional information about a message shown in the Log Messages screen, double-click the message. A Log Message Details box appears, with detailed information about the message. The box also provides buttons for moving to the next or previous message in the message log and an OK button for exiting.



You can save the event log entries as an unformatted text file to disk. The messages saved are the ones shown in Figure 6-2 plus the ones seen when you scroll the page down. Before saving this log, scroll down as far as needed to be sure you will be saving all the messages desired. For more information, see Chapter 5.

6.3 Viewing, Modifying, and Deleting xStack Storage Array Tasks

When the **xStack Storage** icon is selected in the **Physical Resources** tab, you can use the **Tasks Info** screen to view the xStack Storage Array tasks (see Figure 6-3). Examples of tasks include bad block scan and volume initialization activities.

Each row of the **Tasks Info** screen corresponds to a task. The last column, **Recurring**, shows whether the task is recurring and will repeat again in the future.

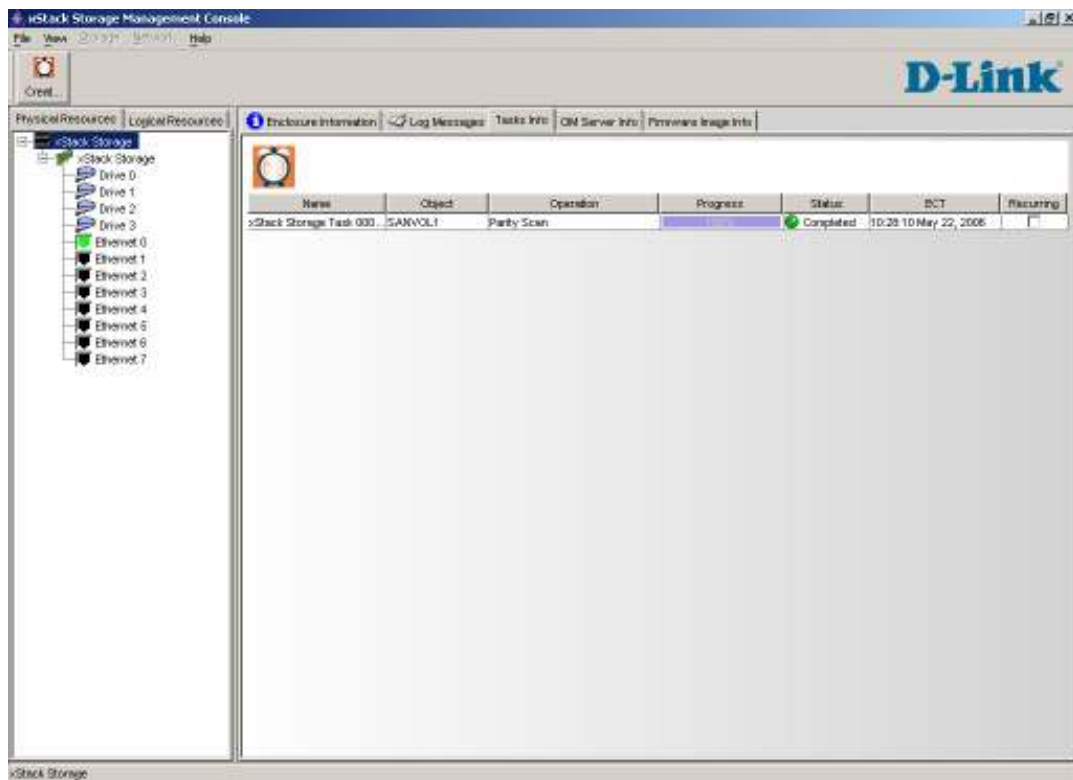

Figure 6-3 Tasks Info Screen

To obtain additional information about a task shown in the **Tasks Info** screen, double-click the task. A **Task Message Details** box appears, with detailed information about the task. If you right-click a task in the **Tasks Info** screen, a popup appears. Depending on the options that are available, you can perform the following tasks from the **Tasks Info** screen:

- Set a priority for the selected task.
- Suspend or resume the task.
- Cancel the task to stop the current task from being performed. If the task was recurring, it will no longer start on any future occurrence.
- Delete the task.

6.4 Viewing Server SMI Information

When the **xStack Storage** icon is selected in the **Physical Resources** tab, you can use the SMI Server Info screen to view Storage Management Initiative (SMI) server and profile information (see Figure 6-4). The SMI Server Information area has an **Edit** button you can click to change the SMI server information if necessary.

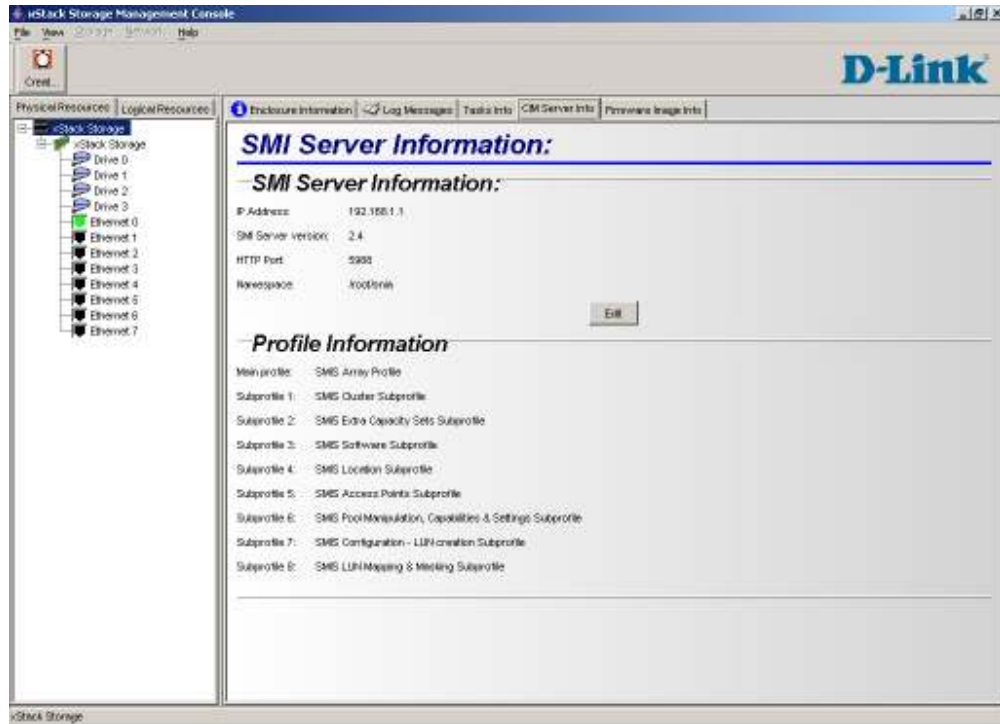

Figure 6-4 SMI Server Information Screen

6.5 Viewing Firmware Image Information

When the **xStack Storage** icon is selected in the **Physical Resources** tab, you can use the Firmware Image Info screen to view the currently active firmware image being used by the xStack Storage Array (see Figure 6-5). This screen also shows other valid firmware images that have been used with the xStack Storage Array.



For information about upgrading the xStack Storage Array firmware, see Appendix E.

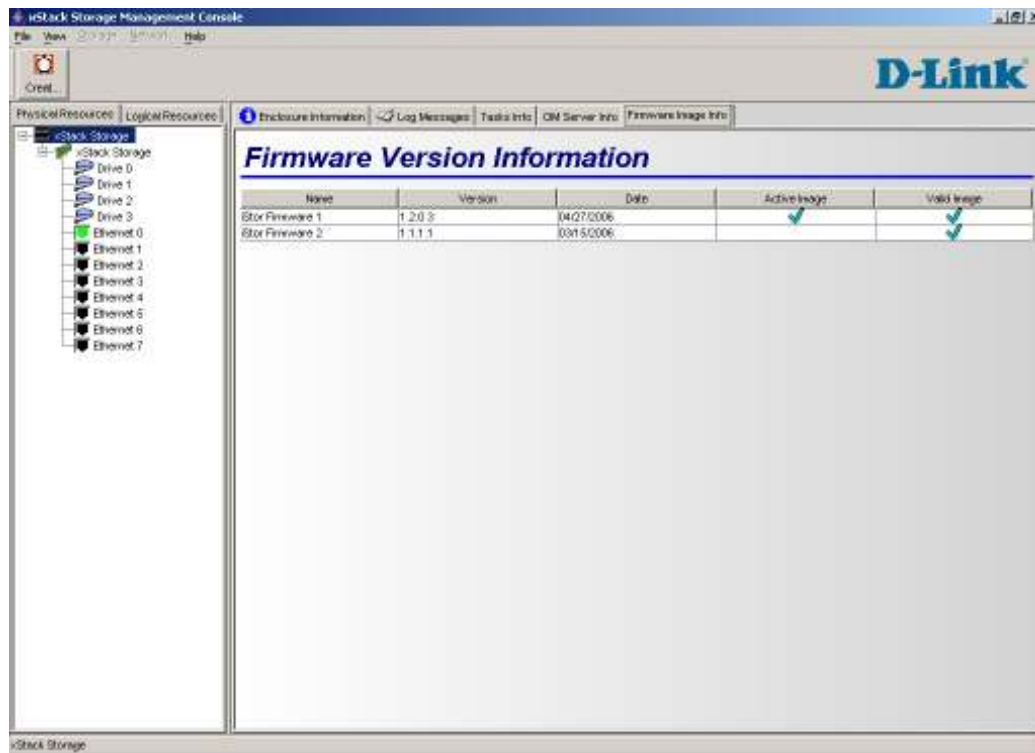

Figure 6-5 Firmware Image Info Screen

6.6 Viewing Storage Pool Information

When **Blade A Base Pool** is selected in the **Logical Resources** tab, you can use the Storage Group Information screen to view information about the storage pool (see Figure 6-6).

The top-left side of the screen shows the storage pool type, amount of free space, total capacity, and number of drives. To the right of this information is a pie chart that provides a graphical representation of the amount of used and unused (free) space in the storage pool. Used space is shown in gray and unused space is shown in green.

Below this information are rows that correspond to the drives attached to the xStack Storage Array. Each row corresponds to a separate drive and shows the drive's:

- Slot number
- State (online, offline, etc.). For readability, the state is color coded (green = online, black = offline).
- Capacity (the actual usable capacity of the drive)
- Utilization percentage
- Allocation

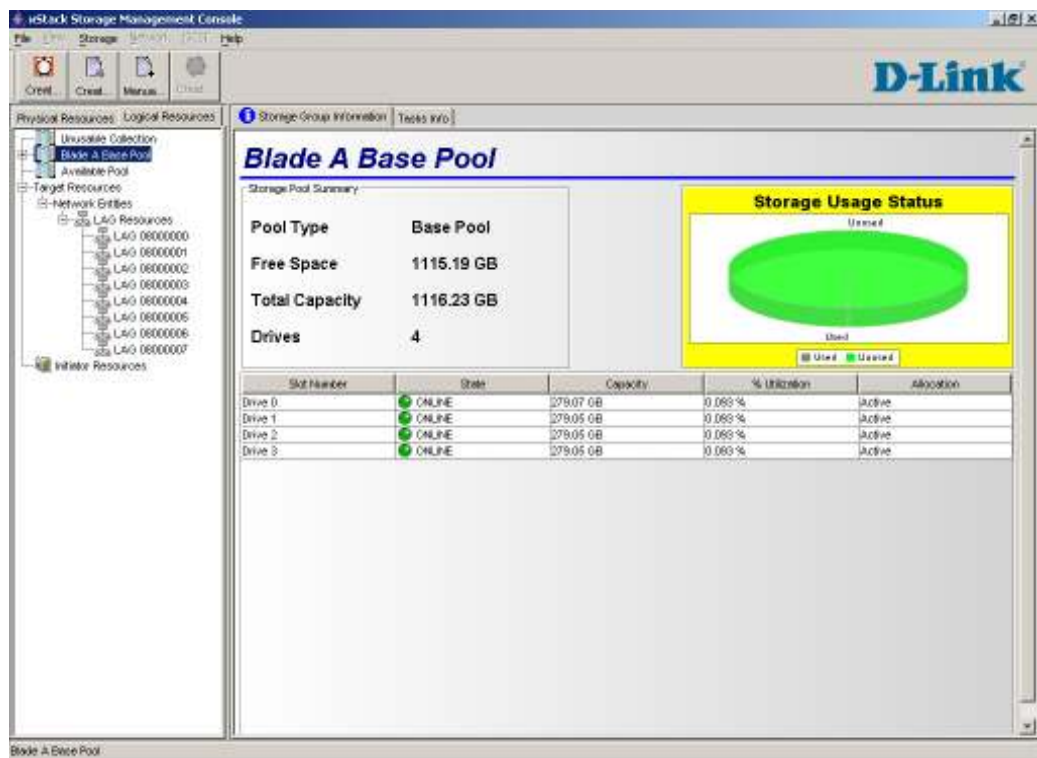

Figure 6-6 Storage Group Information

6.7 Viewing Storage Pool Tasks

When **Blade A Base Pool** is selected in the **Logical Resources** tab, you can use the **Tasks Info** screen to view tasks scheduled for the storage pool (see Figure 6-7). Examples of tasks include media scan and drive initialization activities.

Each row of the **Tasks Info** screen corresponds to a task. The last column, **Recurring**, shows whether the task is recurring and will repeat again in the future.

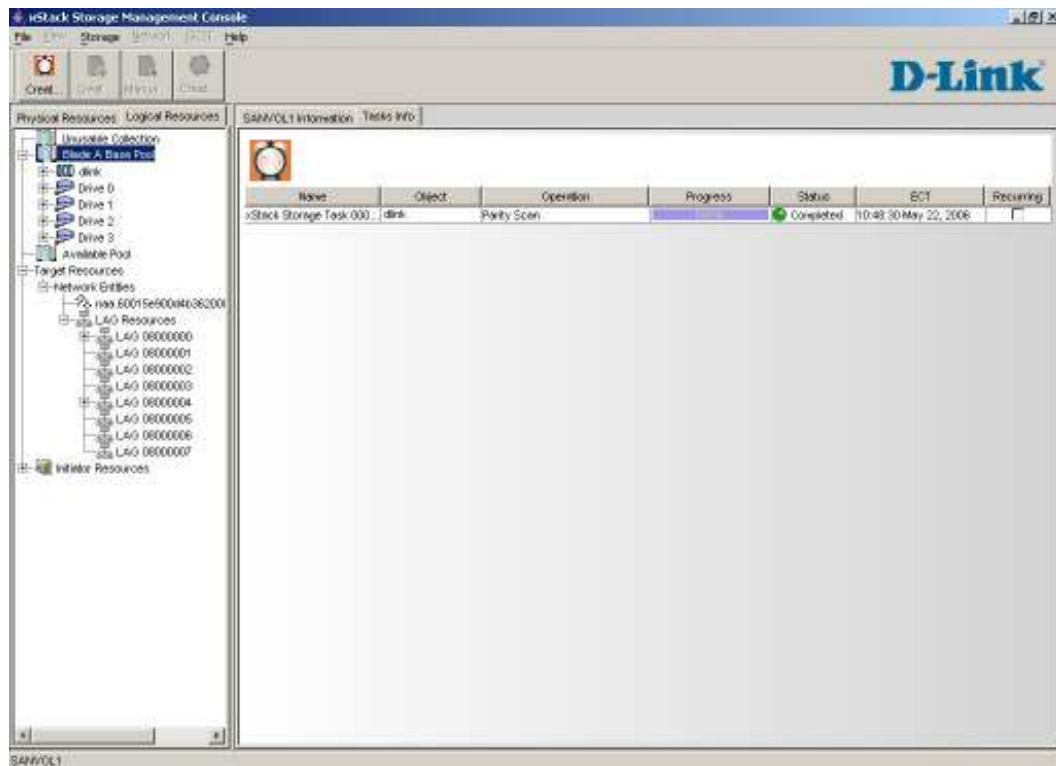

Figure 6-7 Tasks Info Screen

To obtain additional information about a task shown in the **Tasks Info** screen, double-click the task. A **Task Message Details** box appears, with detailed information about the task.

6.8 Viewing Volume Information

When you click a volume under **Blade A Base Pool**, you can use the Volume Information screen to view information about the selected volume.



The name of the volume appears in the tab., for example, shows information for a volume named “dlink.”

The Volume Information screen shows the following information (see Figure 6-8):

- The volume’s durable name and size, volume state and cache status, volume type, storage efficiency and storage bandwidth, and chunk size.
- A graphical representation of the drives associated with the volume.
- A LUN Map that shows the iSCSI target node(s) and LUN Number(s).

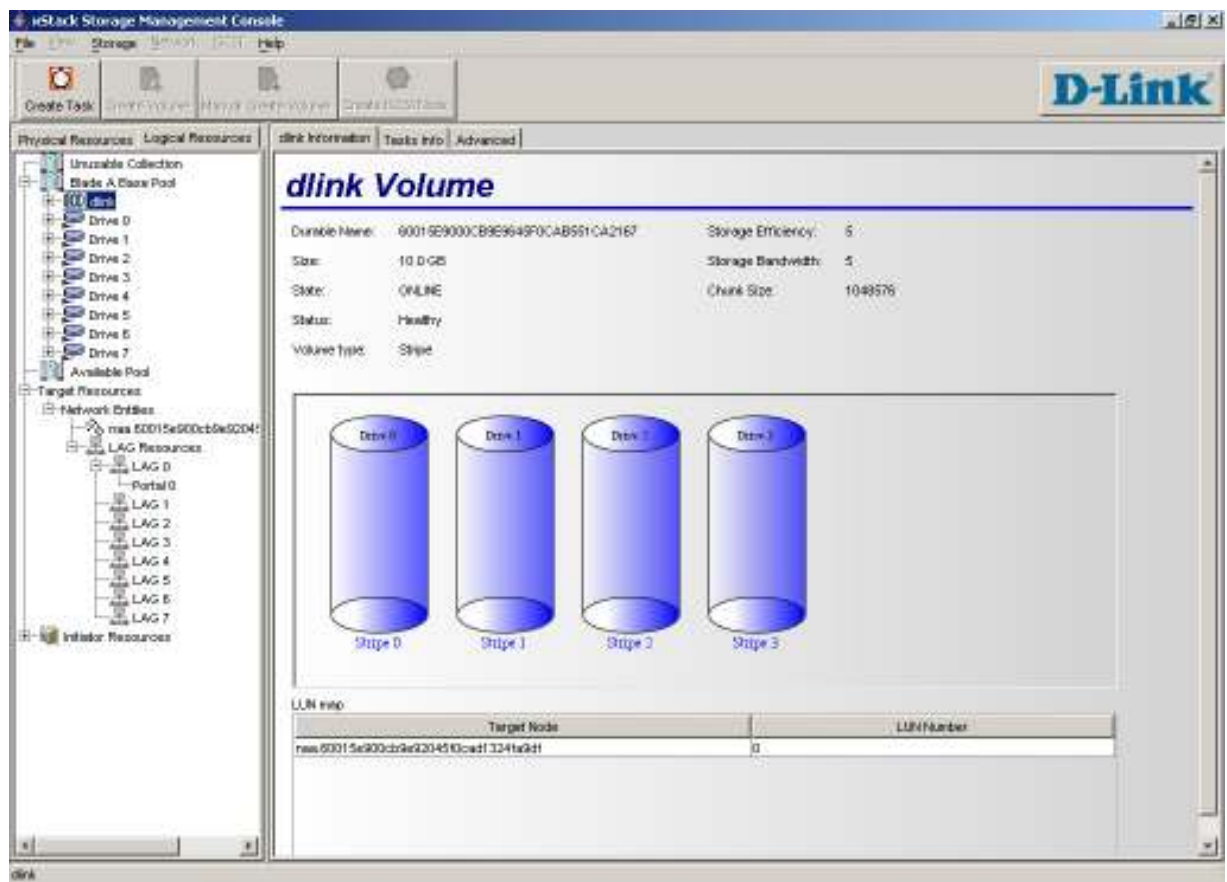

Figure 6-8 Example of Volume Information for a Volume Named dlink

6.9 Viewing Volume Tasks

When you click a volume under **Blade A Base Pool**, you can use the Task Info screen to view tasks assigned to the selected volume. Each row of the Tasks Info screen corresponds to a task assigned to the volume. The information shown for each task is (see Figure 6-9)

- The task name
- The object (volume) assigned the task
- The task (operation) that is to be performed
- The progress of the task
- The status of the task
- The task's estimated completion time (ECT)
- Whether the task is recurring

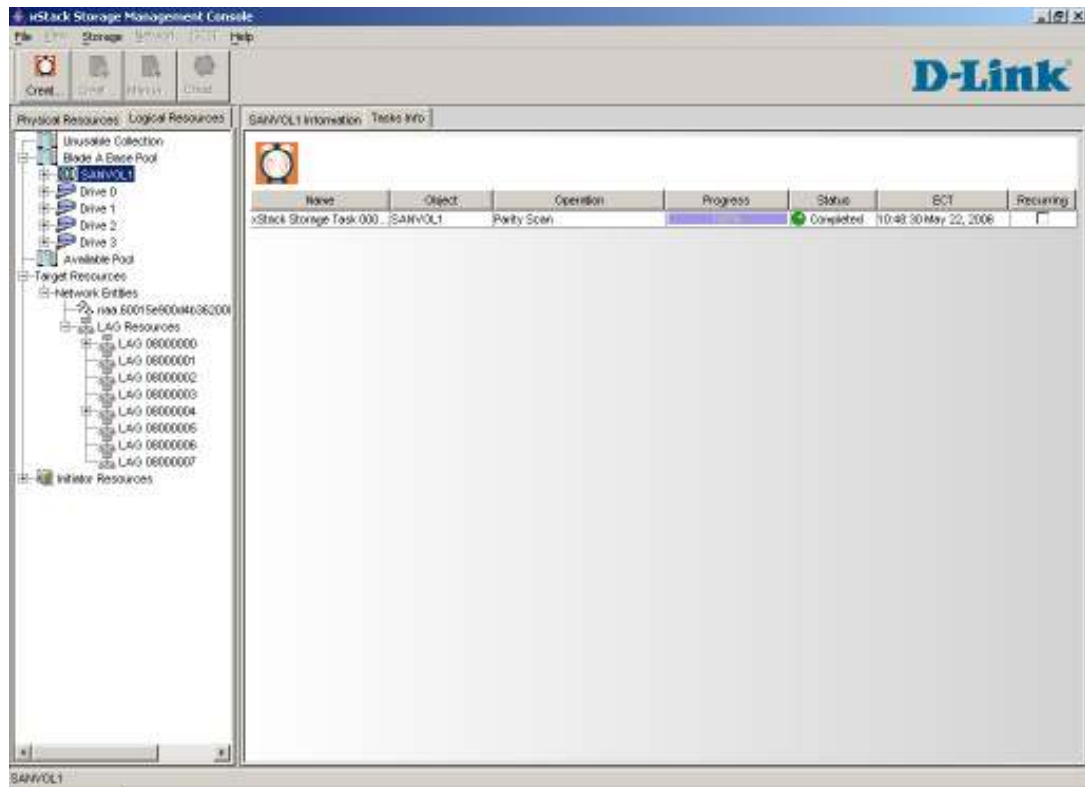

Figure 6-9 Tasks Info Screen

To obtain additional information about a task shown in the Tasks Info screen, double-click the task. A Task Message Details box appears, with detailed information about the task.

6.10 Viewing Information about Drives in the Blade A Base Pool

When a drive is selected under **Blade A Base Pool** in the **Logical Resources** or when a drive is selected on the **Physical Resources** tab, you can view information about the selected drive as described in the following sections.

6.10.1 Viewing Information About Physical Drives

When a drive is selected under **Blade A Base Pool** in the **Logical Resources** or when a drive is selected on the **Physical Resources** tab, the Drive Information screen shows the following information about the selected drive (see Figure 6-10).

- Drive number
- Vendor model
- Serial number
- Physical capacity
- State (for example, online or offline)
- Microcode level
- ATA version
- Supported and actual line speeds
- Support for 48-bit addresses and SATA queuing
- Queue depth

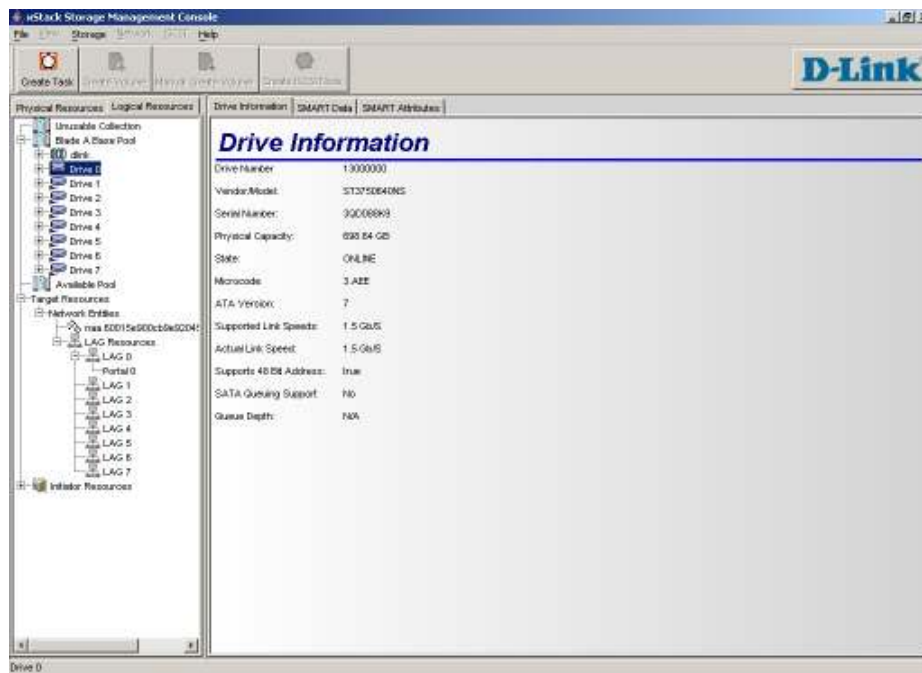

Figure 6-10 Drive Information Screen

6.10.2 Viewing SMART Information for a Drive

Self-Monitoring, Analysis, and Reporting Technology (SMART) is a monitoring system for computer hard disks to detect and report on various indicators of reliability, with the hope of anticipating failures. With SMART, a hard disk's integrated controller works with various sensors to monitor various aspects of the drive's performance, determines from this information if the drive is behaving normally or not, and makes available status information to software that probes the drive and look at it.

The xStack Storage Array collects the SMART information and displays it on the management console in two collections. This information consists of:

- SMART data that serves as a summary of the overall status.
- SMART attributes that are defined differently by each vendor.

To view SMART information for a drive, select a drive under **Blade A Base Pool** in the **Logical Resources** or on the **Physical Resources** tab. You can then use the second tab to view information collected from the SMART data (see Figure 6-11). You may notice a slight delay, as the xStack Storage Array polls this information from the drive (SMART data is polled from the drive every 10 seconds). The third tab displays the SMART attributes in a table (see Figure 6-12). Again, you may notice a slight delay, as the information is polled from the drive (the displayed information refreshes every 10 seconds).

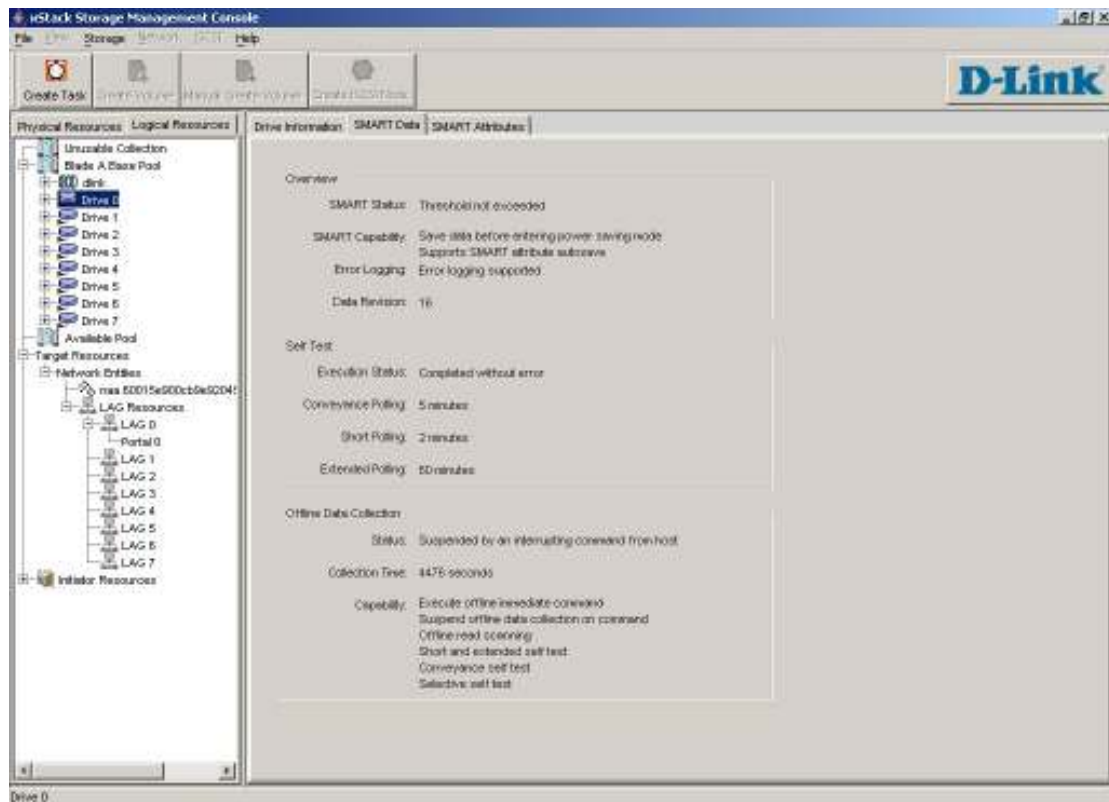

Figure 6-11 Viewing Collected SMART Data

6.11 Viewing Target Node Information

When a network entity is selected in the **Logical Resources** tab, you can use the Target Node Info screen to view the session and connection parameters associated with the selected network entity.

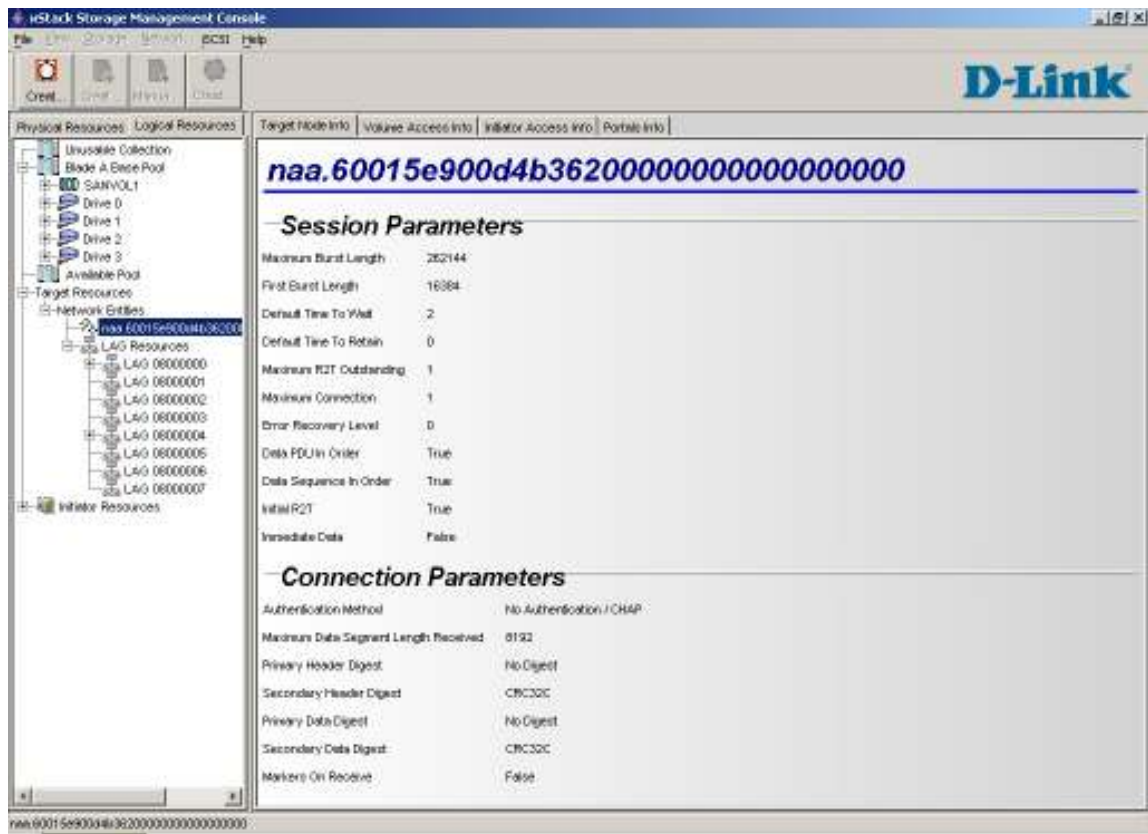

Figure 6-13 Target Node Info Screen

6.12 Viewing Volume Access Information

When a network entity is selected in the **Logical Resources** tab, you can use the Volume Access Info screen to view LUN map information for the volume associated with the selected network entity.

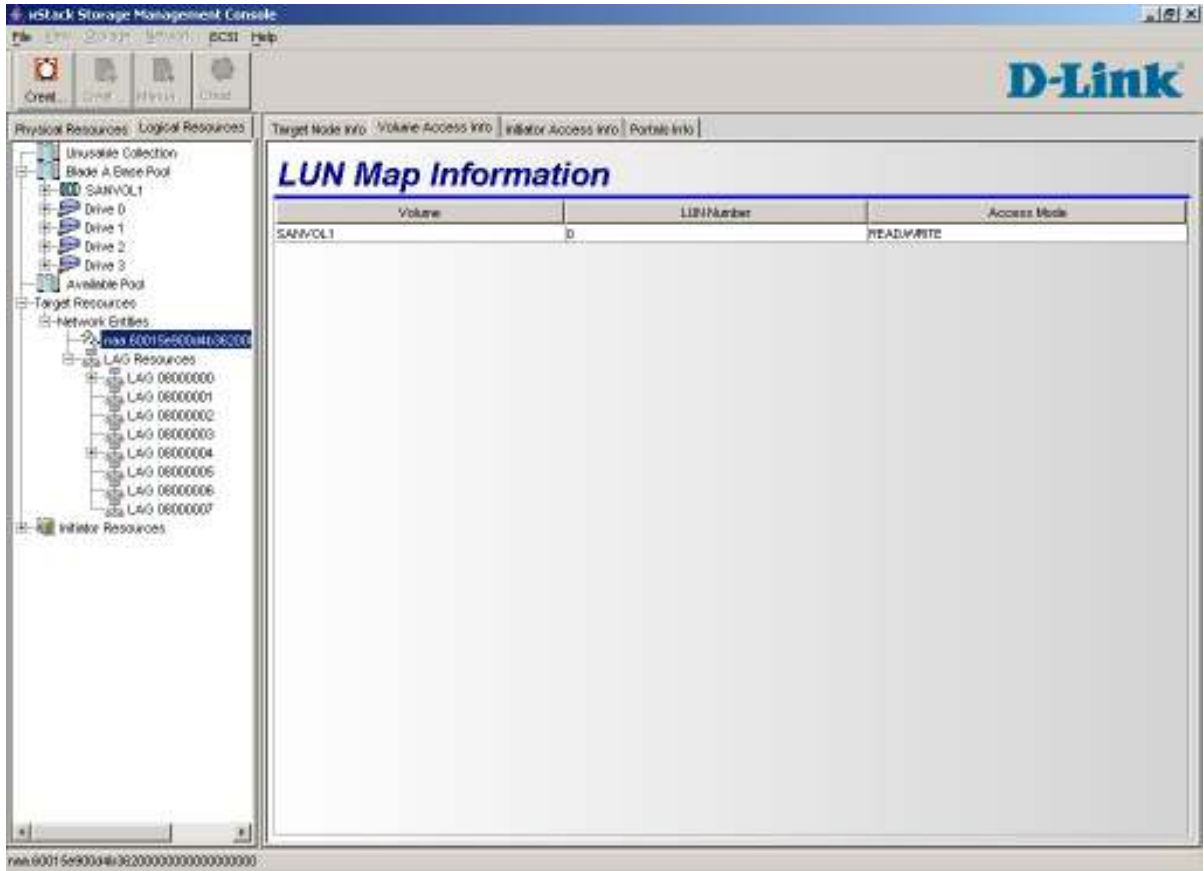

Figure 6-14 Volume Access Info Screen

6.13 Viewing Initiator Access Information

When a network entity is selected in the **Logical Resources** tab, you can use the Initiator Access Info screen to view iSCSI initiator and access information associated with the selected network entity.

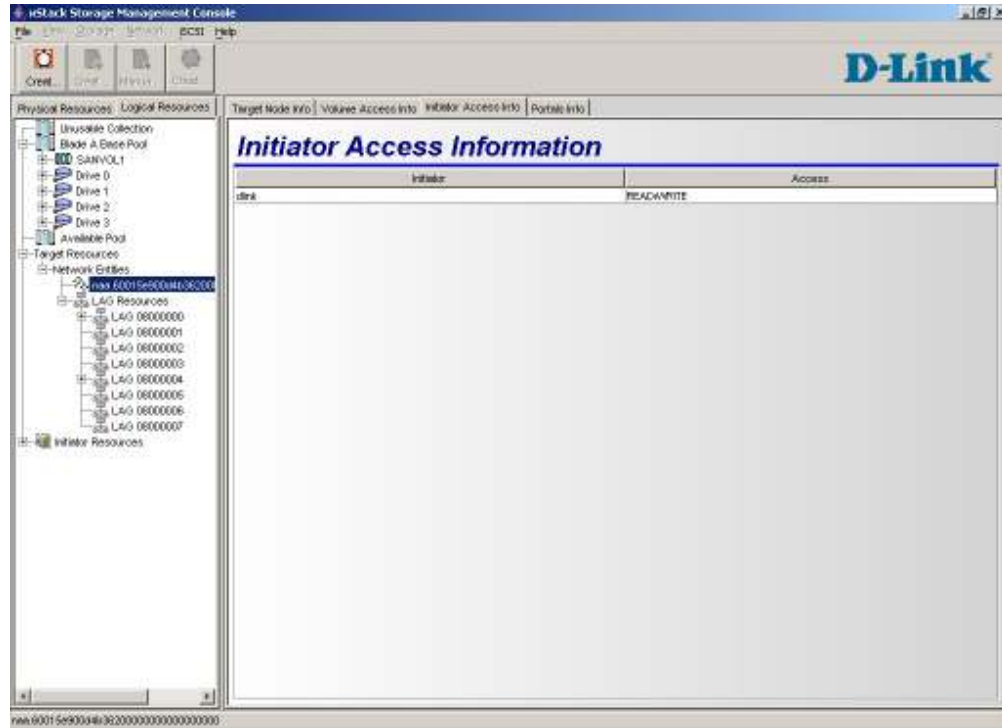

Figure 6-15 Initiator Access Info Screen

6.14 Viewing LAG Port Information

When a LAG is selected in the **Logical Resources** tab, the main display shows the LAG Port Info screen (see Figure 6-16). This screen is divided into the following sections:

- **LAG port information.** This section shows the following information:
 - LAG MAC port address
 - Requested per-port speed
 - Aggregate LAG speed
 - Link status
 - Admin status
 - Ethernet encapsulation
 - VLAN support
 - Auto negotiation
 - MTU
- **Ethernet Port.** This area shows the status of each Ethernet port associated with the LAG port. To enhance viewing, online ports are shown in green.
- **IP Address.** This area shows the IP addresses and corresponding VLAN IDs, if any, associated with the LAG port.

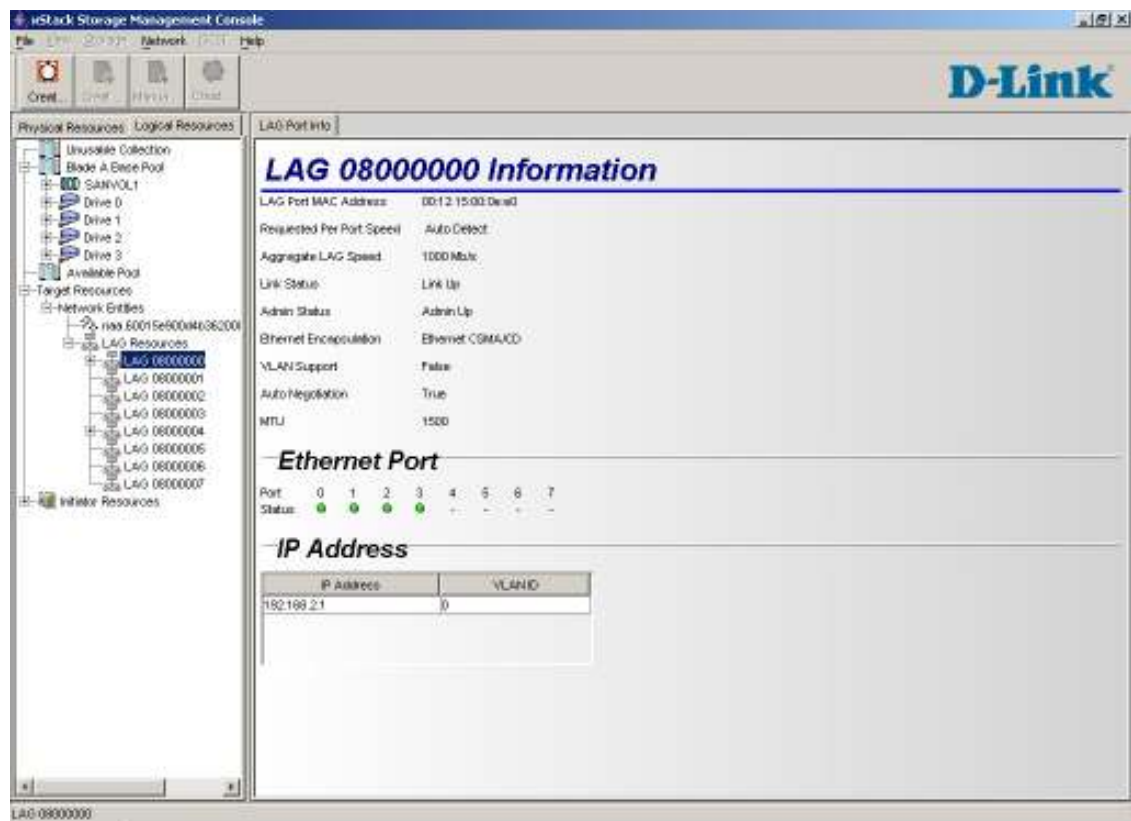

Figure 6-16 LAG Port Info Screen

6.15 Viewing Network Portal Information

When a network entity is selected in the **Logical Resources** tab, you can use the Portals Info screen to view the IP address and port number associated with the selected network entity.

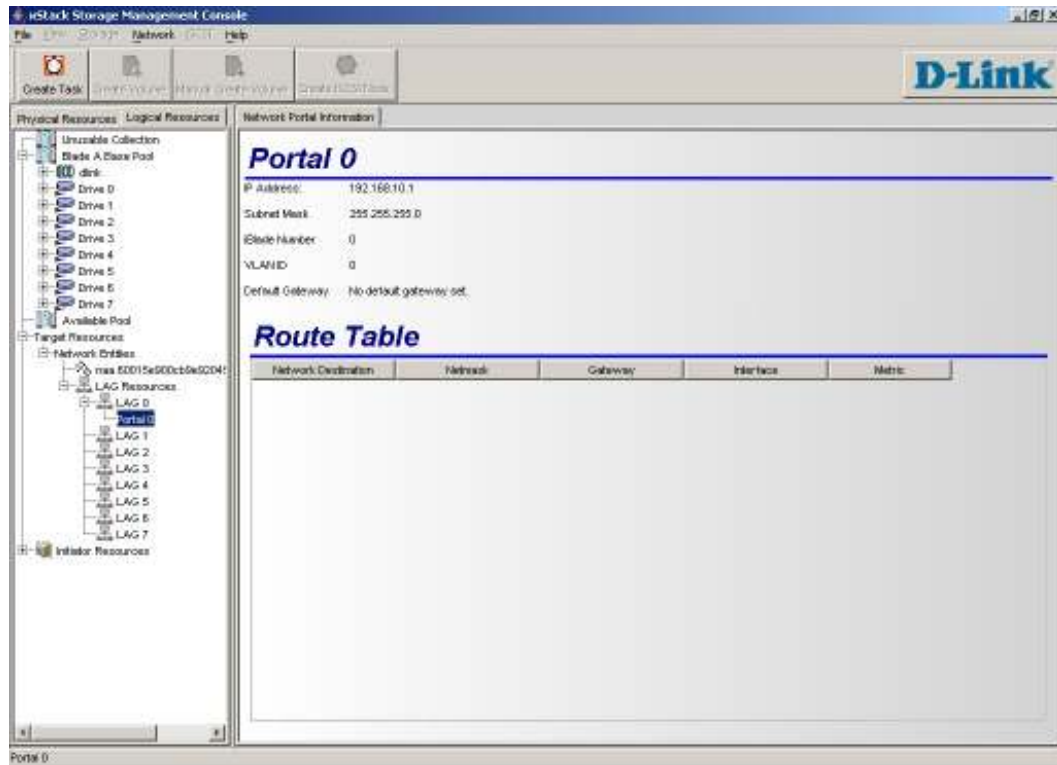

Figure 6-17 Portals Info Screen

6.16 Viewing Connection Information

If you select a connection in the **Physical Resources** tab, you can use the Connection Information screen to view the connection parameters and session information for the selected connection (see Figure 6-18).

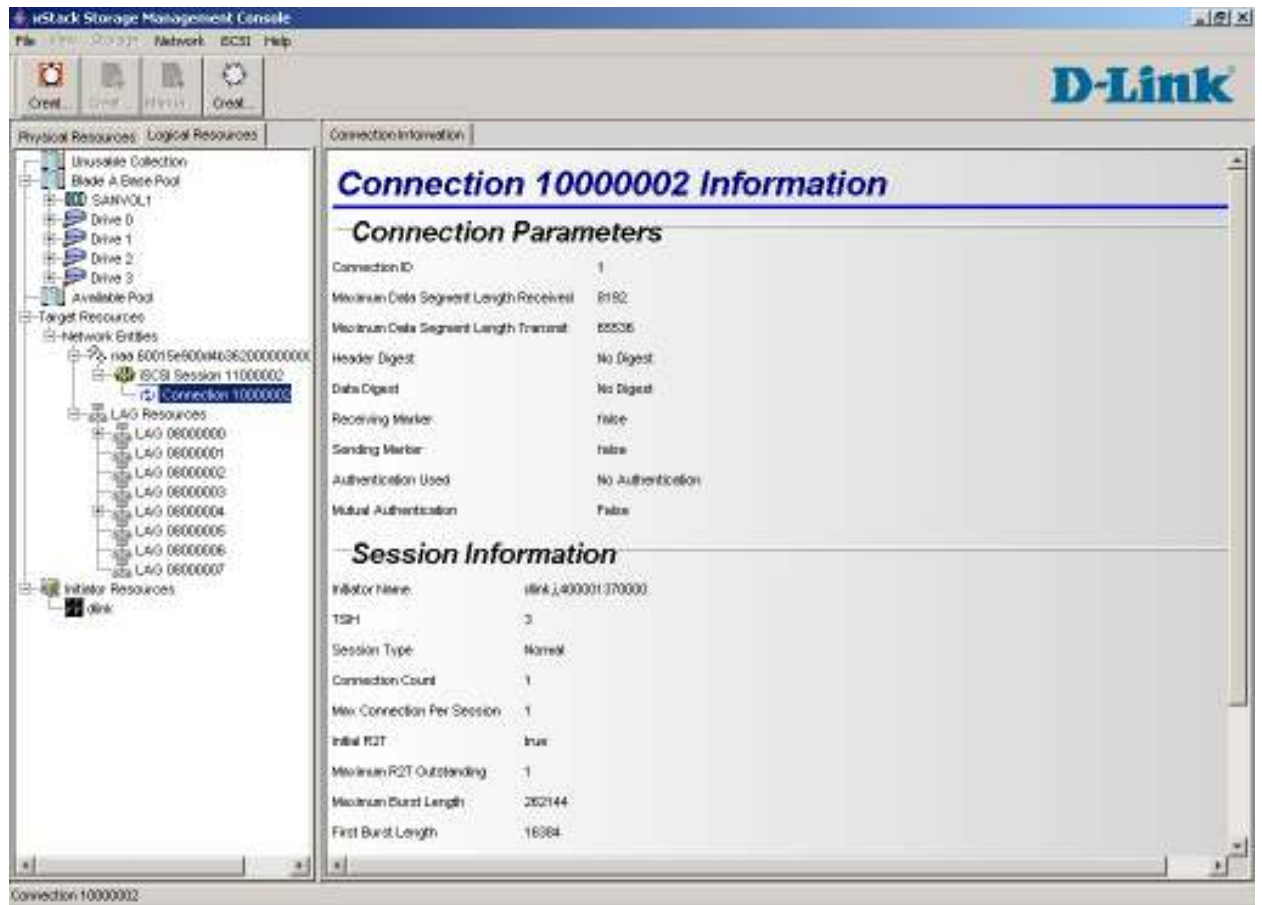

Figure 6-18 Connection Information Screen

6.17 Viewing iSCSI Initiator Information

When an iSCSI initiator is selected in the **Logical Resources** tab, you can use the Initiator Information screen to view information associated with the selected iSCSI initiator (see Figure 6-19).

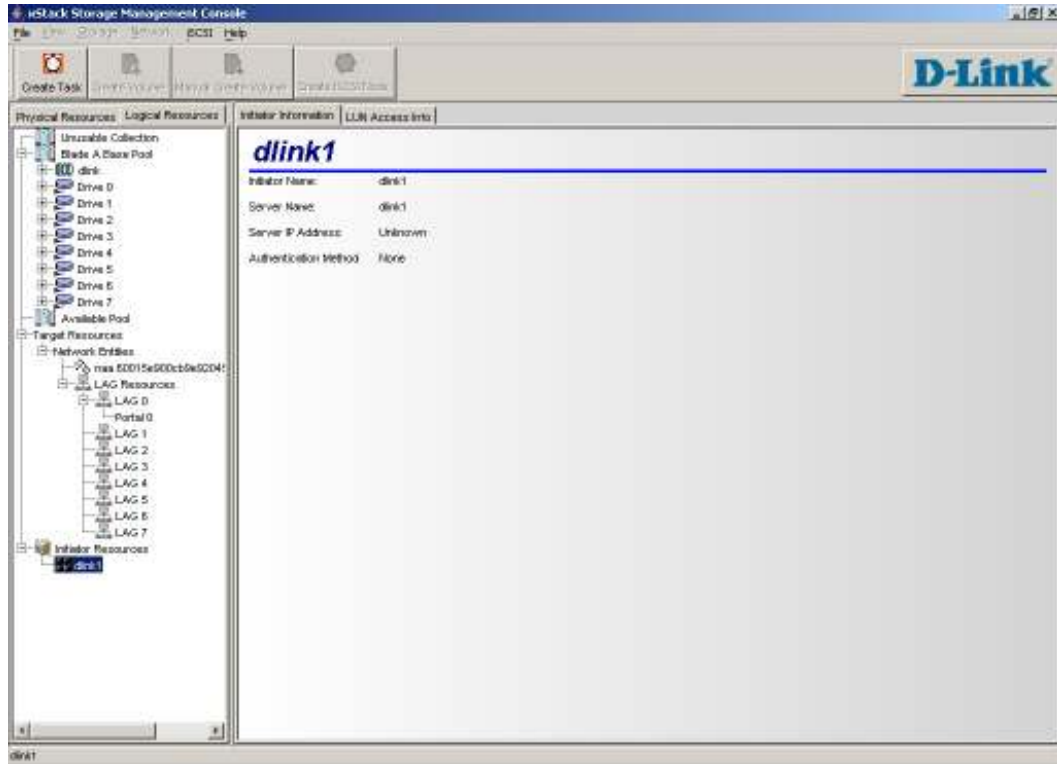

Figure 6-19 Initiator Information Screen

6.18 Viewing LUN Map Information

When an iSCSI initiator is selected in the **Logical Resources** tab, you can use the LUN Map Information screen to view LUN Map information associated with the selected iSCSI initiator (see Figure 6-20)

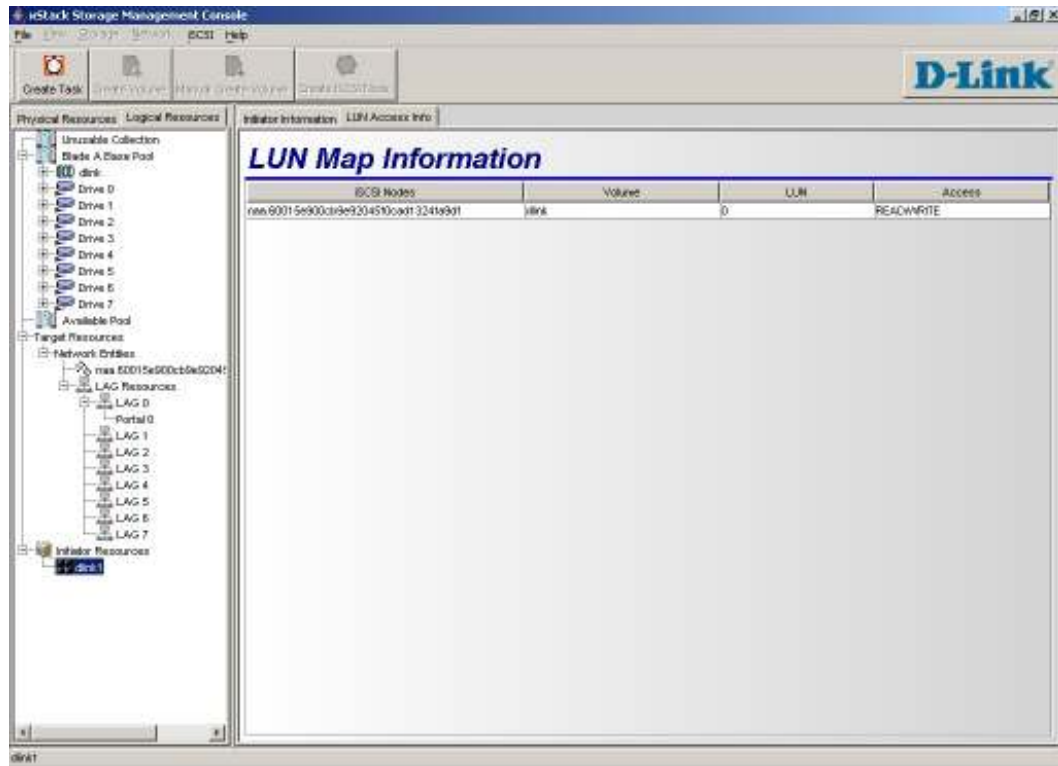

Figure 6-20 LUN Map Information Screen

6.19 Viewing Ethernet Port Information

When an Ethernet port is selected in the **Physical Resources** tab, the main display area shows the physical port information for the selected Ethernet port (see Figure 6-21).

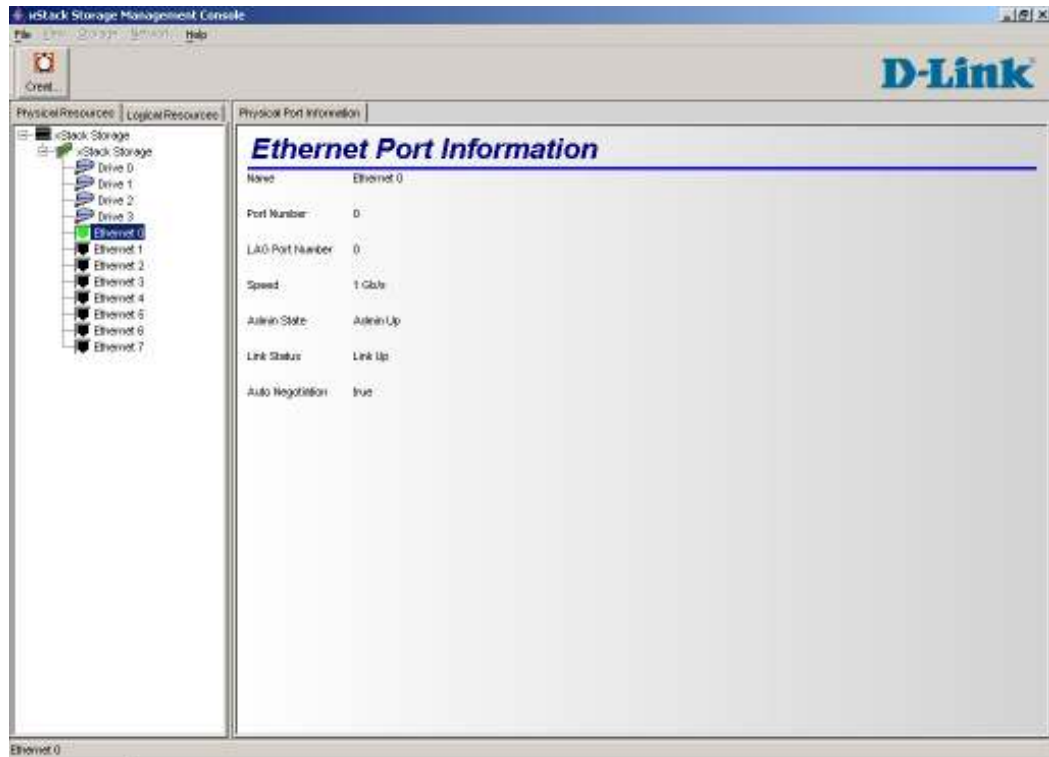

Figure 6-21 Physical Port Information

Chapter 7 Performing Diagnostics

For quick fault isolation, the xStack Storage Array provides two ping connectivity tests:

- One ping connectivity test evaluates the connection between the xStack Storage Array management port and the management console.
- Another ping test evaluates the connection between an xStack Storage Array data port and the iSCSI initiator.

This chapter describes how to perform these ping connectivity tests.

7.1 Pinging from an xStack Storage Array Network Portal

Using the Ping from Out of Band dialog box, you can ping in order to ascertain whether a remote host can be reached from an xStack Storage Array network portal. This function is extremely useful for testing the network port connection to the network, independent of any application in which the original problem may have been detected.

Pinging lets you determine whether further testing should be directed toward the network connection (the lower layers) or the application (the upper layers). If ping shows that packets can travel to the network and back, the problem is probably in the upper layers. If packets cannot make the round trip, lower protocol layers may be at fault.

To ping from a particular xStack Storage Array network portal, use the following procedure:

1. In the **Logical Resources** tab, expand **Network Entities**, **LAG Resources**, and the LAG that controls the desired network portal by clicking the plus sign (+) to the left of the title. Then right-click the desired network portal and click **Ping From**. A dialog box similar to the one in Figure 7-1 appears.

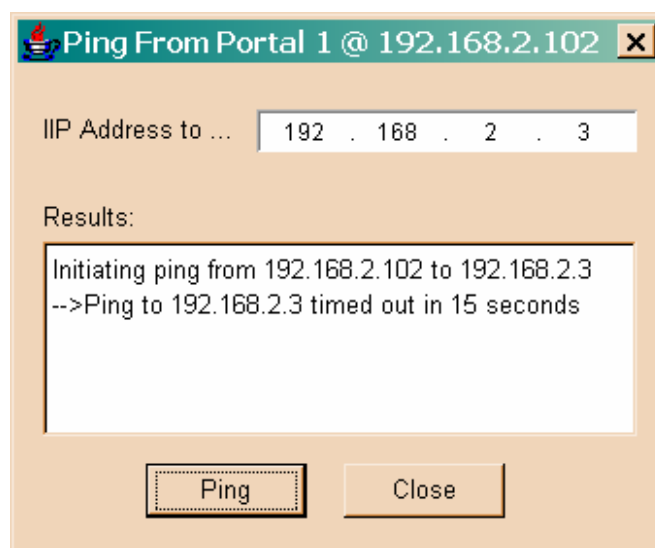

Figure 7-1. Pinging from a Network Portal

2. In the **IP Address to Ping** field, enter the destination IP address of the host.
3. Click the **Ping** button. The results of the ping appear in the **Results** area of the dialog box.
4. When you finish, click the **Close** button to close the dialog box.

7.2 Pinging from the xStack Storage Array Management Port

The Ping Out of Band dialog box also lets you ping or locate the management workstation connected to the xStack Storage Array management port.

To ping from the xStack Storage Array management port, use the following procedure:

1. Select the **Physical Resources** tab.
2. On the **File** menu, click **Ping from Out of Band Port**. A dialog box similar to the one in Figure 7-2 appears.
3. In the **IP Address to Ping** field, enter the destination IP address of the management workstation.
4. Click the **Ping** button. The results of the ping appear in the **Results** area of the dialog box.
5. When you finish, click the **Close** button to close the dialog box.

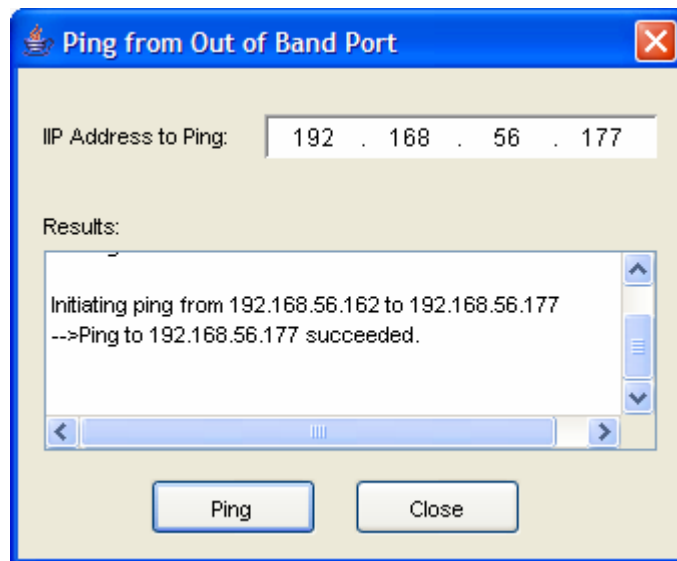

Figure 7-2. Pinging from the Management Port

Appendix A Factory Default Settings

This appendix lists the factory-default settings for the xStack Storage Array.

Table A-1. Configure Out of Band Port Default Settings

Parameter	Default Value
IP Address After Restart	192.168.1.1
Subnet Mask After Restart	255.255.255.0
Hostname After Restart	hn<serial number of xStack Storage Array controller board>
Gateway After Restart	0.0.0.0.

Table A-2. Battery Policy Default Setting

Parameter	Default Value
If the battery fails, the xStack Storage Array should	Ignore the status of the battery and do nothing (I have a UPS)

Table A-3. Date and Time Default Setting

Parameter	Default Value
Timezone	UTC

Table A-4. Modify System TCP/IP Default Settings

Parameter	Default Value
Max. Segment Size	8960
Window Scale	0
Time To Live (TTL)	64
PMTU Enabled	True

Table A-5. Set Default Task Priority Default Setting

Parameter	Default Value
Default Priority	5

Table A-6. Set Spare Count Default Setting

Parameter	Default Value
Number of Spare Counts	0

Table A-7. Modify iSCSI Port Default Setting

Parameter	Default Value
New SCSI Port	3260

Table A-8. Email Notification Support Default Setting

Parameter	Default Value
Enable Email Notification Support	Disabled
SMTP Server	0.0.0.0
SMTP Port	25

Appendix B Recording Your Configuration Settings

This appendix contains tables you can use to record the configuration settings. Please print this out and use it as a hard copy reference.

B.1 Recording Out-of-Box Settings

Use Table B-1 to record the initial settings you specify when you run the OOBE setup wizard.

Table B-1. Out-of-Box Settings

Parameter	Initial Setting
Management Port Settings	
IP Address	
Subnet	
Default Gateway	
Host name	
Administrator Account Settings	
Admin Password	
Date/Time Settings	
Date and Time	
Time Zone	
Email Notification Settings	
Enable Email Support	
SMTP Server IP Address	
Port Number	
From	
To	

Appendix C Performing Advanced Diagnostics

The xStack Storage Array provides two menus for performing advanced diagnostics, one that can be accessed through the serial port and another that can be accessed through the management port.

The serial port diagnostic menu is accessed during startup. This menu lets you reset all admin passwords, download configuration parameters, access the Enclosure Services Test Tool, or continue with the boot operation. For more information, see Section C.1.

The management port diagnostic menu is used if the xStack Storage Array is operational, but the management console is not available. This menu lets you reset the xStack Storage Array to factory defaults, reboot or shut down the xStack Storage Array, and change the out-of-band port configuration. To access this menu, you must know the login username and password. For more information, see Section C.2.

C.1 Accessing the Serial Port Diagnostic Menu

This method requires that you have physical access to the xStack Storage Array itself. To access the xStack Storage Array serial port diagnostic menu, use the following procedure:

1. Shut down the xStack Storage Array.
2. Connect a PC to the xStack Storage Array diagnostic serial port using the provided female DB9 to female DB9 cable

From the connected PC, launch a terminal-emulation program configured as follows:

- Terminal type: VT-100
 - Bits per second: 9600 bps
 - Data bits: 8
 - Parity: None
 - Stop bits: 1
 - Flow control: none
3. Turn the xStack Storage Array power on. When you are prompted to press the Enter key to stop autostart, press Enter. The serial port startup menu in Figure C-1 appears.

```
Press the Enter key to stop autostart:
Startup menu:
1. Reset all admin account passwords
2. Download configuration
3. Enclosure Services Test Tool
4. Continue with boot operation

Enter menu number desired:
```

Figure C-1. Serial Port Diagnostic Menu

5. From the serial port diagnostic menu, type the appropriate number for the option you want to perform:
 - To reset all admin account passwords, type **1** and press the Enter key. This selection removes every user account that had either Manage Storage or Manage User Accounts privileges, and creates a single account with the user name admin and password admin (if it doesn't already exist) with both privileges. After you confirm your desire to reset all admin accounts, the Startup menu appears again. Type **4** and press Enter to continue to start the xStack Storage Array.
 - To download configuration parameters, type **2** and press the Enter key. Use this selection to set the xStack Storage Array configuration from a TFTP server. When selected, you are prompted for the IP address of your TFTP server. The next prompt requests the file name containing the configuration. After the new configuration is downloaded, the Startup menu appears again. Type **4** and press Enter to continue to start the xStack Storage Array
 - To access the Enclosure Services Test Tool, type **3** and press the Enter key.
 - To skip the serial port startup menu and continue with the startup operation, type **4** and press the Enter key.

C.2 Accessing the Management Port Diagnostic Menu

If the xStack Storage Array is operational, but the management console is not accessible, you can use the following procedure to access the management port diagnostic menu.

1. Be sure your PC Ethernet port is connected so that it has access to the xStack Storage Array management port. There must be physical connectivity, either a direct connection or through a switch, and both the PC and the xStack Storage Array must have IP addresses on the same subnet.
2. Telnet to the xStack Storage Array management port. The example Figure C-2 uses a Microsoft Windows Telnet application. This screen was accessed by clicking the **Start** button and then clicking **Run**, typing **telnet 192.168.1.1** in the Run dialog box, and clicking **OK**.

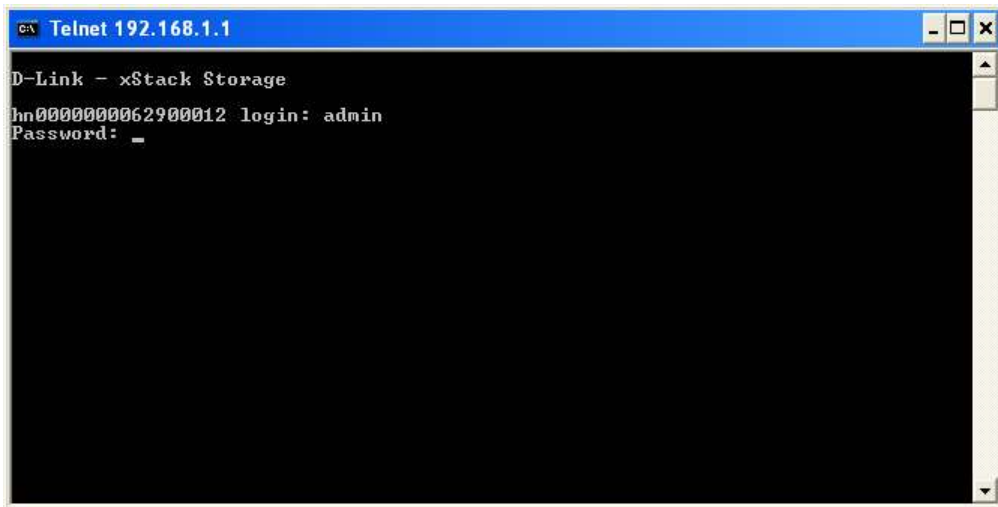

Figure C-2. Password Prompt

3. At the login prompt, enter a valid user name (the default is **admin**) and press the Enter key.
4. At the password prompt, enter the password for that user name (the default is **admin**) and press Enter. The management port diagnostic menu in Figure C-3 appears.

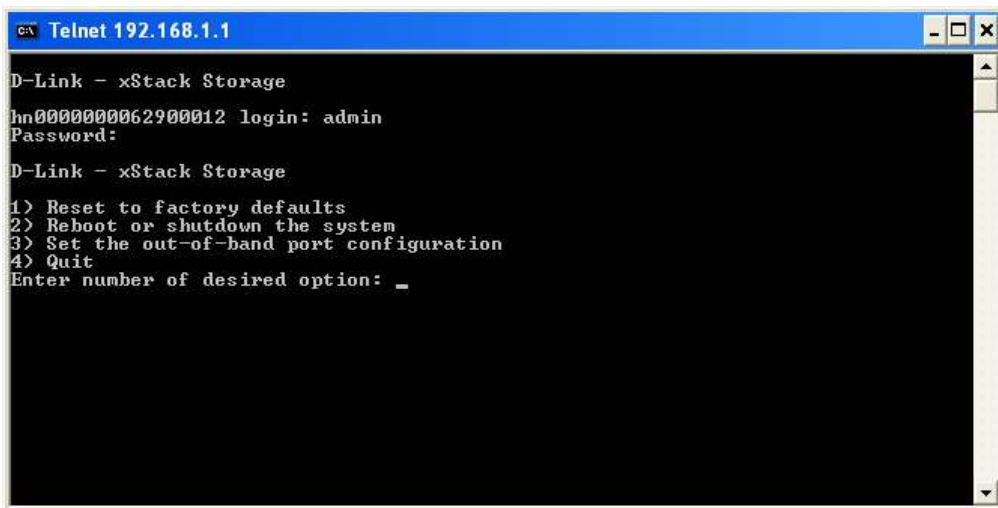

Figure C-3. Management Port Diagnostic Menu

5. From the management port diagnostic menu, type the appropriate number for the option you want to perform:
 - 1 = Reset the xStack Storage Array to factory-default settings (see Section C.2.1)
 - 2 = Reboot or shut down the xStack Storage Array (see Section C.2.2)
 - 3 = Set the out-of-band port configuration (see Section C.2.3)
 - 4 = Quit (exit) the management port diagnostic menu

C.2.1 Restoring Factory Defaults

To reset the xStack Storage Array to factory-default settings, use the following procedure. This procedure will require you to restart the xStack Storage Array.

1. From the management port diagnostic menu, type **1** and press Enter. A prompt asks whether you also want to reset the management port IP address (see Figure C-4).

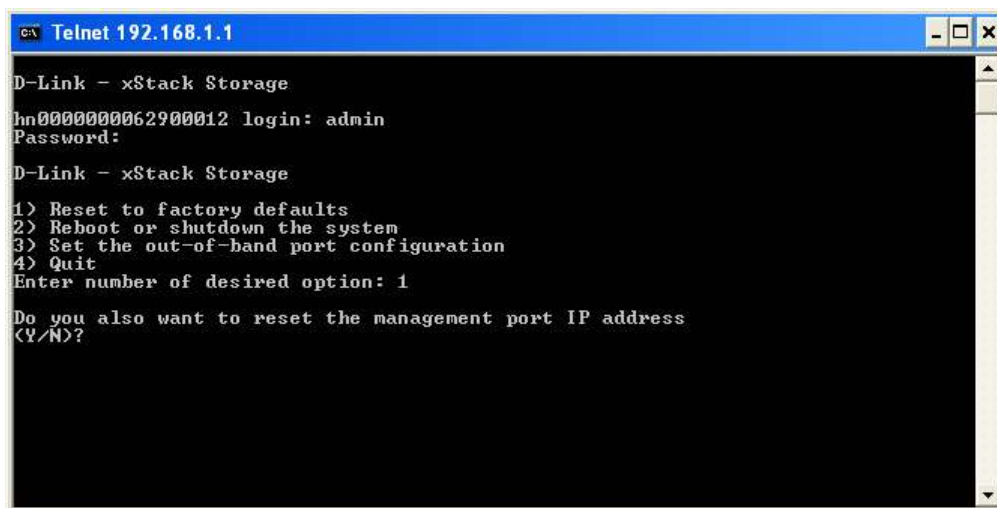

```

c:\ Telnet 192.168.1.1
D-Link - xStack Storage
hn0000000062900012 login: admin
Password:
D-Link - xStack Storage
1) Reset to factory defaults
2) Reboot or shutdown the system
3) Set the out-of-band port configuration
4) Quit
Enter number of desired option: 1
Do you also want to reset the management port IP address
(Y/N)?
```

Figure C-4. Prompt for Resetting the Management Port IP Address

2. To also reset the management port IP address to its default setting, type **y**. Otherwise, type **n**.
3. Press Enter. A prompt asks whether you are sure you want to reset the xStack Storage Array to factory-default settings (see Figure C-5).

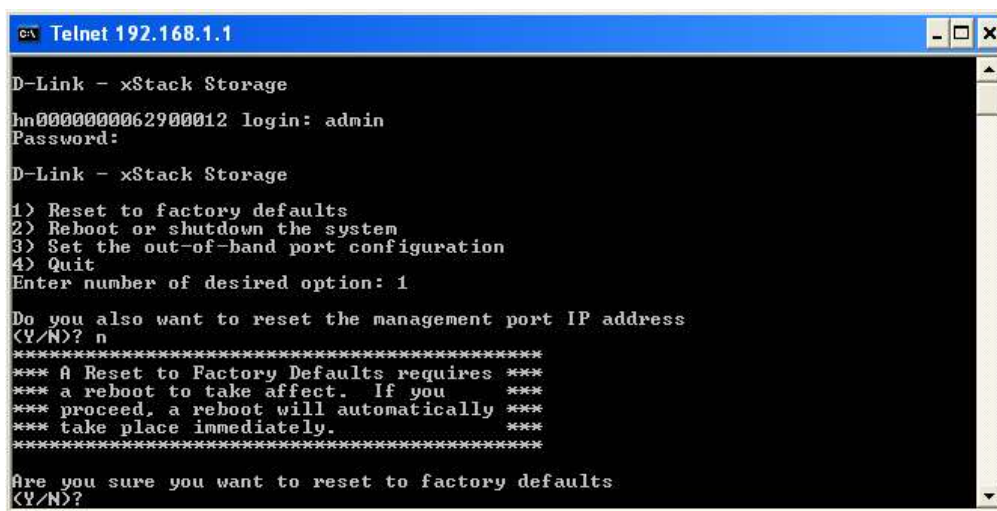

```

c:\ Telnet 192.168.1.1
D-Link - xStack Storage
hn0000000062900012 login: admin
Password:
D-Link - xStack Storage
1) Reset to factory defaults
2) Reboot or shutdown the system
3) Set the out-of-band port configuration
4) Quit
Enter number of desired option: 1
Do you also want to reset the management port IP address
(Y/N)? y
*****
*** A Reset to Factory Defaults requires ***
*** a reboot to take affect. If you ***
*** proceed, a reboot will automatically ***
*** take place immediately. ***
*****
Are you sure you want to reset to factory defaults
(Y/N)?
```

Figure C-5. Prompt for Resetting the xStack Storage Array to Factory-Default Settings

4. To reset to the factory-default settings, type **y**. Otherwise, type **n**.
5. Press Enter. The xStack Storage Array restarts.

C.2.2 Rebooting or Shutting Down the System

To reboot or shut down the xStack Storage Array, use the following procedure:

1. From the management port diagnostic menu, type 2 and press Enter. A prompt asks you to enter the number of the desired option (see Figure C-6).

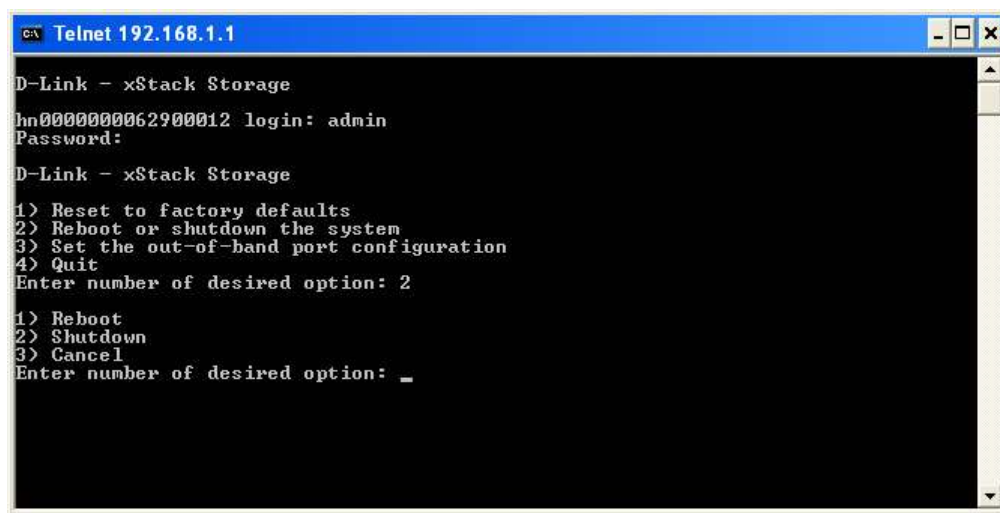

```

C:\> Telnet 192.168.1.1

D-Link - xStack Storage
hn0000000062900012 login: admin
Password:

D-Link - xStack Storage
1> Reset to factory defaults
2> Reboot or shutdown the system
3> Set the out-of-band port configuration
4> Quit
Enter number of desired option: 2

1> Reboot
2> Shutdown
3> Cancel
Enter number of desired option: _

```

Figure C-6. Prompt for Rebooting or Shutting Down the xStack Storage Array

2. Perform one of the following steps:
 - To reboot the xStack Storage Array, type 1.
 - To shut down the xStack Storage Array, type 2.
 - To cancel the operation and return to the management port diagnostic menu, type 3.
3. Press Enter. The xStack Storage Array performs the action that corresponds to the number you typed in the previous step.

C.2.3 Setting the Out-of-Band Port Configuration

To set the xStack Storage Array out-of-band configuration, use the following procedure:

1. From the management port diagnostic menu, type 3 and press Enter. The current xStack Storage Array IP address, subnet mask, gateway, and hostname are displayed (see Figure C-7) and you are prompted to enter a new IP address for the management port.



```

C:\ Telnet 192.168.1.1
D-Link - xStack Storage
hn00000006290012 login: admin
Password:
D-Link - xStack Storage
1) Reset to factory defaults
2) Reboot or shutdown the system
3) Set the out-of-band port configuration
4) Quit
Enter number of desired option: 3
Getting current out-of-band port configuration.
Current IP is      192.168.1.1
Current subnet mask is 255.255.255.0
Current gateway is  0.0.0.0
Current hostname is hn00000006290012
Enter new IP address [192.168.1.1]: _

```

Figure C-7. Example of xStack Storage Array Settings

2. To keep the current IP address for the management port, press Enter. Otherwise, enter a new address and press Enter. You are prompted for a subnet mask.
3. To keep the current subnet mask for the management port, press Enter. Otherwise, enter a new subnet mask and press Enter. You are prompted for a gateway.
4. To keep the current gateway, press Enter. Otherwise, enter a new gateway and press Enter. You are prompted for a hostname.
5. To keep the current hostname, press Enter. Otherwise, enter a new hostname and press Enter. A message says you must reboot the xStack Storage Array for the new settings to take effect, and then asks whether you want to change the management port IP address.
6. To reset the management port IP address, type y. Otherwise, type n. If you typed y, the new management port settings take effect the next time the xStack Storage Array restarts.

Appendix D Replacing and Upgrading FRUs

This appendix describes how to replace or upgrade the Field Replaceable Units (FRUs) in your xStack Storage Array. FRUs that can be replaced or upgraded include:

- Battery Pack
- System and buffer memory
- SATA drives
- Fans
- Uninterruptible power supplies

D.1 Installing the Battery Pack

The xStack Storage Array accommodates a 4-cell or 6-cell shrink-wrapped battery pack. Because write-back caching is always enabled, we recommend you have a battery to back up the buffer cache contents.

To install a battery in your xStack Storage SAN Array, follow these steps:

1. Hold the battery as shown to align the fastener pad. Make sure the battery cable and connector is located nearest to the battery socket J35 on the controller (see Figure D-1).



Figure D-1 Aligning the Battery

2. Press the battery down firmly as shown in Figure D-2 until you feel it lock into place.

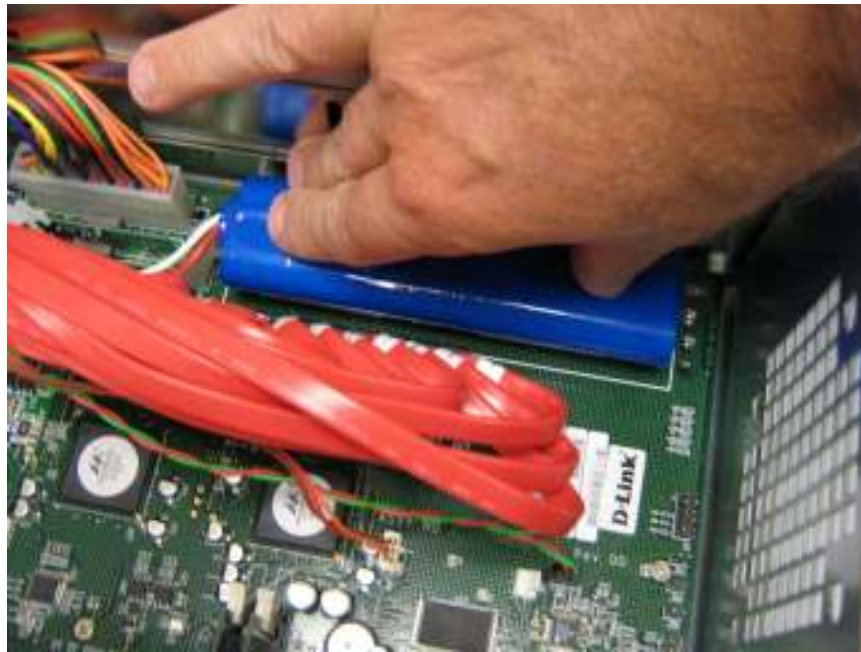

Figure D-2 Press the Battery Down Firmly Until it Locks

3. Align the battery plug with connector J35 as shown in Figure D-3 and insert it fully into the socket.

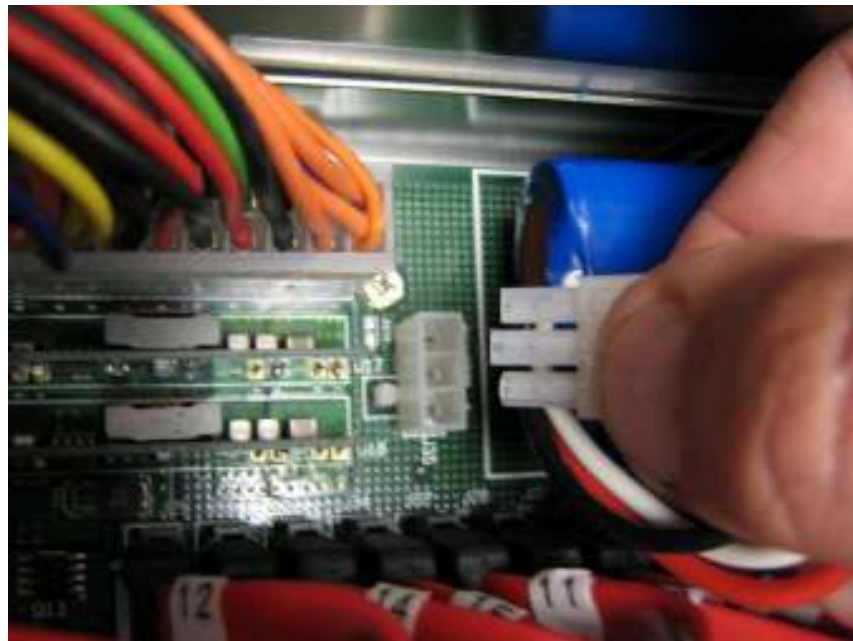

Figure D-3 Align the Battery Plug with Connector J35

4. The connector locked firmly into connector J35.



Figure D-4 Battery Plug Locked in Place

5. The installed battery is shown in Figure D-5.

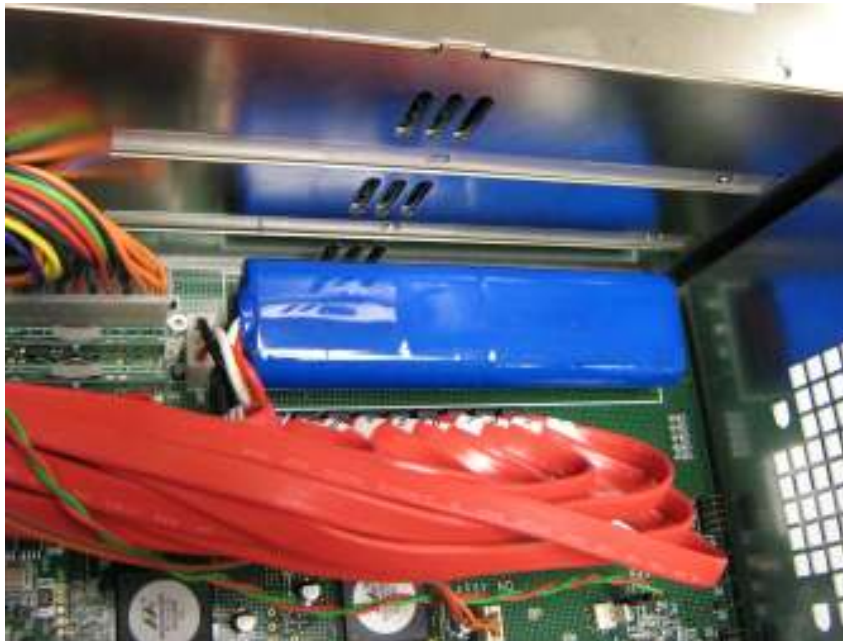

Figure D-5 The Installed Battery

D.2 Installing Memory

The xStack Storage Array provides four memory sockets:

- Two sockets (J36 and J37) are for buffer memory
- Two sockets (J38 and J39) are for system memory

System Memory: The xStack Storage controller can address up to 2GB of system memory, but only 512MB are required for operation of your controller. Your controller will have come standard with at least 512MB (2 x 256MB modules) making upgrading of system memory not necessary. Please see Figure D-6 system memory location.

Buffer (Cache) Memory: The xStack Storage controller can address up to 2GB of buffer memory, and comes standard with at least 512MB (2 x 256MB modules) installed. This should work well for most applications. However, several applications (such as video streaming) of the product could benefit from increased cache memory. Please see Figure D-6 for buffer memory location. **Note on Memory:** The xStack Storage controller's system and buffer memory must be installed as matching pairs. Table D-1 lists the specifications for DIMMs supported by the xStack Storage Array. These memory module specifications are crucial to the operation of your SAN array. Please visit the www.dlink.com website for tested memory modules.

Table D-2 shows the possible memory configurations for your xStack Storage controller. Please note that you must use matching memory modules for DIMM0 & DIMM1 as well as matching memory modules for DIMM2 & DIMM3.

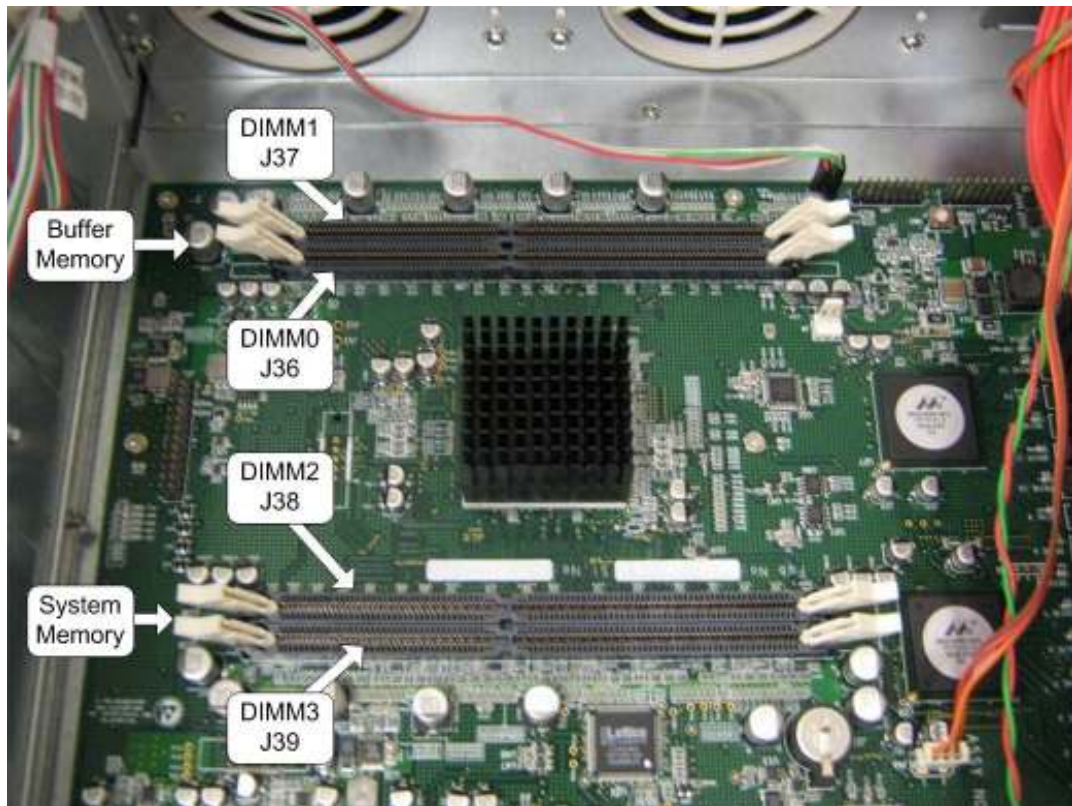

Figure D-6 Buffer and System Memory Location

Table D-1. xStack Storage Array DIMM Specifications

Requirement	Description
PC2700/DDR333 speed	SDRAMs must be JEDEC compliant and DDR333 capable, with a CAS latency of 2.5. PC3200/DDR400 speed DIMMs can be used if they support a 2.5 CAS latency when operating at DDR333 speed.
ECC	DIMMs must be organized as x72 bits wide, allowing support for ECC.
X8 RAMs	DIMMs must use 8-bit wide DRAMs that can support data mask (DM) signals. DIMMs that use 4-bit-wide DRAMs do not provide DM signals and cannot be used.
Registered	DIMMs must be registered as per the JEDEC specification for registered DIMMs.
Buffered	DIMMs must be buffered as per the JEDEC specification for buffered DIMMs.
Organization	Conforming DIMM organizations are shown in Table D-2..

Table D-2. DIMM Organization

DIMM 0 (J36) System Memory Module	DIMM 1 (J37) System Memory Module	Total System Memory	DIMM 2 (J38) Cache Memory Module	DIMM 3 (J39) Cache Memory Module	Total Cache Memory	Total Memory
256MB	256MB	512MB	256MB	256MB	512MB	1GB
256MB	256MB	512MB	512MB	512MB	1GB	1.5GB
256MB	256MB	512MB	1GB	1GB	2GB	2.5GB
256MB	256MB	512MB	2GB	2GB	4GB	4.5GB

D.3 Installing or Replacing SATA Drives



Removal of a populated drive/tray assembly can have unforeseen effects including the loss of all data in a volume. A drive can be part of a volume that may or may not be redundant. Before removing a drive from an operating xStack Storage Array, make sure it is the correct one.

D.3.1 Drive and Tray Removal

A drive/tray assembly can be removed by pressing upwards on the green latch found on the tray and removing it with the handle as shown in Figure D-7 and Figure D-8.



Figure D-7 Drive and Tray Removal



Figure D-8 Remove Drive/Tray

D.3.2 Installing a Hard Drive in a Drive Tray

Follow these steps to install a hard drive in a drive tray.

1. Remove the plastic air dam from the tray by squeezing the two levers together and lifting the piece out of the tray as shown in Figure D-9.



Figure D-9 Removing the Plastic Air Dam Piece

2. Your tray should now look like Figure D-10.



Figure D-10 Tray with Air Dam Removed

3. Place new hard drive in tray as shown in Figure D-11.



Figure D-11 Place Hard Drive in Tray

4. Align the mounting holes and insert four mounting screws to hold the drive securely in the drive tray as shown in Figure D-12.



Figure D-12 Secure the Hard Drive in the Drive Tray

5. Your hard drive is ready for installation. Proceed to D.3.3.



D.3.3 Drive and Tray Installation

A drive/tray assembly can be installed by inserting the drive/tray assembly into the open drive bay as shown in Figure D-13. Push the tray at the point indicated in Step 2 of Figure D-14 and push until it is seated firmly within the bay. As you press, you will see the tray handle begin to move inwards as the locking mechanism enters the locking slot. When you see this, then you must push the tray handle inwards as shown in Figure D-15 until you hear the green locking mechanism click.



Figure D-13 Drive/Tray Installation



Figure D-14 Press Here Until You See the Lever Move Inwards



Figure D-15 Press Lever Inwards Until it Locks

D.4 Replacing a Fan

The xStack Storage Array contains three user replaceable fans. They can be replaced as follows.

1. Locate the failed fan. They can be identified by their green handle as seen in Figure D-16.



Figure D-16 A User Replaceable Fan with Green Handle

2. Lift the handle, grasp it and pull the fan upwards as seen in Figure D-17.



Figure D-17 Lift the Handle and Pull Upwards

3. Remove the fan from its socket as seen in Figure D-18.

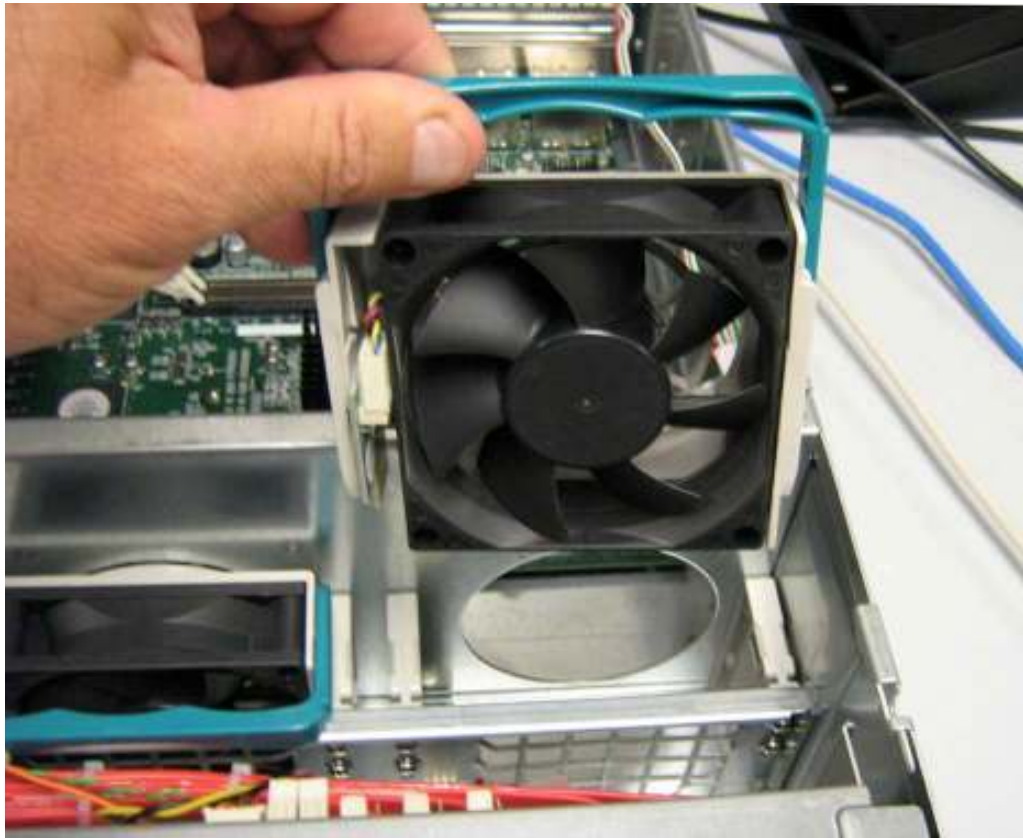

Figure D-18 Remove the Fan

4. Insert the new fan by reversing the previous steps. i.e. Insert fan into socket, press firmly downwards until it is seated and lower the handle to lock it in place.

D.5 Replacing a Power Supply

The xStack Storage Array contains three user replaceable power supply modules. They can be replaced as follows.

1. Locate the failed power supply module. Unscrew the bolt holding the locking mechanism in place as shown in Figure D-19.



Figure D-19 Unscrew the Bolt Holding the Locking Mechanism

2. Push the locking lever to the left and pull on the handle as shown in Figure D-20.



Figure D-20 Push the Locking Lever to the Left and Pull Handle

3. Remove the power supply module as shown in Figure D-21.



Figure D-21 Remove the Power Supply Module

4. Insert the new power supply module by reversing the previous steps. i.e. Insert the new power supply module into the bay until it seats against the rear and the lever locks. Then screw the locking bolt into place.

Appendix E Upgrading Firmware

D-Link periodically updates the firmware for the xStack Storage. The latest firmware releases are available at the D-Link Support Web site.

1. Go to the D-Link Support Web site (support.dlink.com).
2. Select your product model number from the pull-down menus.
3. Select the firmware topic.
4. Download the firmware.
5. When prompted to save the firmware file, click **Save** and save the file to a desired location.



On a piece of paper, write the location and folder where you download the firmware file. You will need to access this location later in this procedure.

6. Launch the xStack Storage Web Manager.
7. On the **View** menu, click **Firmware Upgrade**. The message in Figure E-1 Firmware Upgrade Message appears.

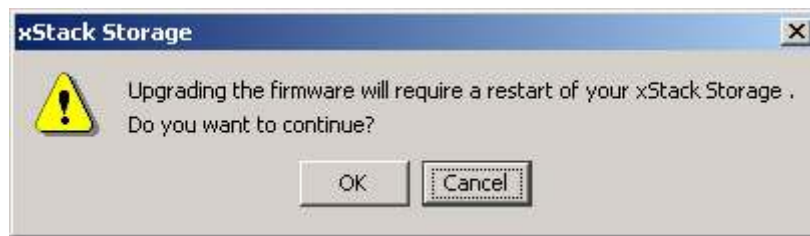

Figure E-1 Firmware Upgrade Message

8. Click **OK** to continue. (Or click **Cancel** to exit without upgrading the firmware.) If you click **OK**, the Open dialog box appears (see Figure E-2).

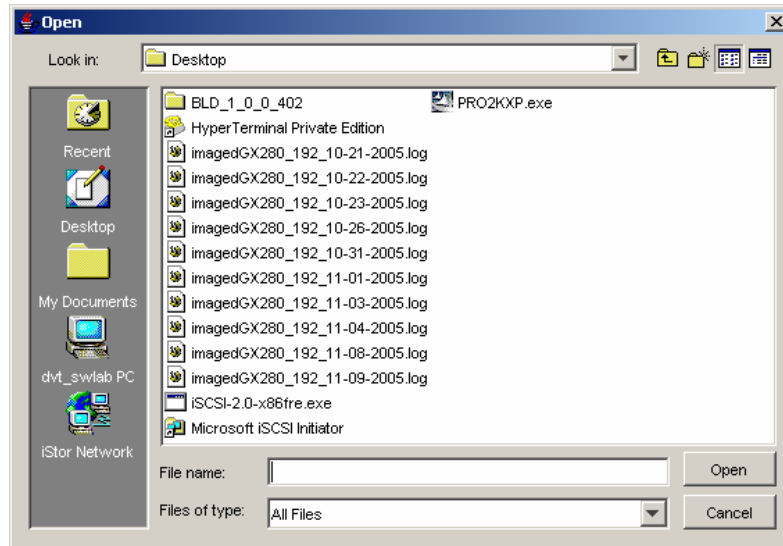

Figure E-2 Example of the Open Dialog Box

9. Navigate to the location where the firmware file you downloaded resides.
10. Click the firmware file, then click the **Open** button. (Or as a shortcut, double-click the firmware file). The new firmware is installed. A progress bar shows the status of the installation.
11. After the firmware is installed, a message prompts you to press **OK** to restart the xStack Storage to have the new firmware take effect.
12. Click **OK** to restart the xStack Storage. If additional messages appear, click **OK** to remove them.
13. After the xStack Storage restarts, launch your Web browser again and log in to the xStack Storage management console.



The Firmware Image Info screen shows the current active firmware image being used by the xStack Storage. For more information, refer to Section 6.5.

Appendix F Hardware Enclosures

This appendix shows samples of hardware enclosures for the xStack Storage.

F.1 Front View



Figure F- 1 Front View of Enclosure

F.2 Back View



Figure F- 2 Rear View of Enclosure

Appendix G Acronyms and Abbreviations

Administrator	The person responsible for managing storage operations. The administrator is the user who will use the storage management console provided with the xStack Storage.
CHAP	Challenge Handshake Authentication Protocol. CHAP is a protocol for authenticating the peer of a connection and is based upon the peers sharing a secret (a security key similar to a password).
CSMA/CD	Carrier Sense Multiple Access/Collision Detection. The LAN access method used in Ethernet. When a device wants to gain access to the network, it checks whether the network is quiet (senses the carrier). If it is not, it waits a random amount of time before retrying. If the network is quiet and two devices access the line at exactly the same time, their signals collide. When the collision is detected, they both back off and each waits a random amount of time before retrying.
Drive	A physical storage drive (usually, but not necessarily, a disk drive) managed by the xStack Storage system.
802.3	An IEEE standard for a CSMA/CD local-area network access method, which is used in Ethernet, the most common LAN technology.
Extent	A contiguous set of LBs on a drive. An extent is also called a physical extent.
IETF	Internet Engineering Task Force. The main standards organization for the Internet. The IETF is a large open international community of network designers, operators, vendors, and researchers concerned with the evolution of the Internet architecture and the smooth operation of the Internet. It is open to any interested individual.
Initiator node	An iSCSI node that performs as an iSCSI Initiator in accessing data stored on the xStack Storage system.
IP	Internet Protocol. IP specifies the format of packets, or “datagrams,” and the addressing scheme. Most networks combine IP with a higher-level protocol called Transmission Control Protocol (TCP), which establishes a virtual connection between a destination and a source. IP by itself is something like the postal system. It allows you to address a package and drop it in the system, but there’s no direct link between you and the recipient. TCP/IP, on the other hand, establishes a connection between two hosts so that they can send messages back and forth for a period of time. The current version of IP is IPv4.
iSCSI	Internet Small Computer System Interface. An IP-based standard for linking data storage devices over a network and transferring data by carrying SCSI commands over IP networks. iSCSI supports a Gigabit Ethernet interface at the physical layer that allows systems supporting iSCSI interfaces to connect directly to standard Gigabit Ethernet switches and/or IP routers. iSCSI was developed by the IETF and became an official standard in February 2003.

LAG	Link Aggregation Group. The combining of physical network links into a single logical link for increased bandwidth. A LAG increases capacity and availability of the communications channel between devices using existing Fast Ethernet and Gigabit Ethernet technology. LAGs also provide load balancing, where processing and communications activity is distributed across several links in a trunk, so that no single link is overwhelmed.
LAN	Local Area Network. A computer network that spans a relatively small area. Most LANs are confined to a single building or group of buildings. Most LANs connect workstations and personal computers. Each node (individual computer) in a LAN has its own CPU with that executes programs, but it can also access data and devices anywhere on the LAN. This means that many users can share expensive devices, such as laser printers, as well as data. Users can also use the LAN to communicate with each other, by sending e-mail or engaging in chat sessions. There are many different types of LANs. Ethernet is the most common LAN for PCs.
LB	Logical Block. A block of storage stored (and read) by the system.
LUN	Logical Unit Number. According to the SCSI Architectural Model, the number used by an iSCSI initiator to access a target's Logical Unit. In the xStack Storage, a logical unit is a volume.
MAC Address	Media Access Control address. A hardware address that uniquely identifies each node of a network.
Member	A group of chunks organized vertically in an array.
Mirror	A method for improving reliability of a Volume by providing data redundancy. In a mirror volume, data redundancy is provided by recoding every data block on more than one drive.
MPU	Management Processor Unit. The PowerPC CPU used for management processing on the xStack Storage.
Node	A computer or other device, such as a printer. Every node has a unique network address, sometimes called a Data Link Control (DLC) address or Media Access Control (MAC) address.
Parity	A way to improve reliability of a volume by providing data redundancy. In a parity volume, data redundancy is improved by recording data blocks across multiple drives and recording one additional parity block on an additional drive. If any single drive fails, the original data can be reconstructed from the remaining blocks.
PLBN	Physical Logical Block Number. The number of an LB on a drive.
RFC	Request for Comments. A series of notes about the Internet started in 1969. An Internet Document can be submitted to the IETF by anyone, but the IETF decides if the document becomes an RFC. If the RFC gains enough interest, it may evolve into an Internet standard. Each RFC is designated by an RFC number. Once an RFC is published, it never changes. Modifications to an original RFC are assigned a new RFC number.

SAN	Storage Area Network. A high-speed subnetwork of shared storage devices that makes all storage devices available to all servers on a LAN or WAN. As storage devices are added to a SAN, they will be accessible from any server in the larger network. In this case, the server merely acts as a pathway between the end user and the stored data. Because stored data does not reside directly on any network servers, server power is used for business applications, and network capacity is released to the end user.
Server	A computer or device on a network that manages network resources. For example, a network server is a computer that manages network traffic. Servers are often dedicated, meaning that they perform no other tasks besides their server tasks. On multiprocessing operating systems, however, a single computer can execute several programs at once. A server in this case can refer to the program that is managing resources rather than the entire computer.
Striping	A way to improve I/O performance on a volume by splitting data among multiple drives.
Storage pool	A collection of drives used as a group for common functions (for example, the space used by a volume must be allocated from a specific storage pool).
Subnet	A portion of a network that shares a common address component. On TCP/IP networks, subnets are defined as all devices whose IP addresses have the same prefix. For example, all devices with IP addresses that start with 100.100.100. are part of the same subnet.
TCP	Transmission Control Protocol. Pronounced as separate letters, TCP is a main protocol in TCP/IP networks. Whereas the IP protocol deals only with packets, TCP enables two hosts to establish a connection and exchange streams of data. TCP guarantees delivery of data and also guarantees that packets will be delivered in the same order in which they were sent.
VLBN	Virtual Logical Block Number. The number of an LB within a volume. The LB is used to store customer data.
Volume	A fixed amount of storage on a disk. The term volume is often used as a synonym for the storage medium itself, but it is possible for a single disk to contain more than one volume or for a volume to span more than one disk.

