



# DKVM-8E

8- Port Keyboard, Video,  
and Mouse Switch

## User's Guide

Rev. 1.0



# TABLE OF CONTENTS

---

<b>Introduction</b> .....	<b>1</b>
<b>Product Feature</b> .....	<b>1</b>
<b>Package Content</b> .....	<b>2</b>
<b>Hardware Installation</b> .....	<b>4</b>
Front Panel Layout.....	4
Real Panel Layout.....	5
Installation.....	5
Usage.....	11
Daisy Chain Diagram.....	15
Hot Plug.....	16
<b>On Screen Display Operation</b> .....	<b>18</b>
BANK: 1 .....	18
<b>01</b> .....	<b>18</b>
<b>02</b> .....	<b>18</b>
<b>03</b> .....	<b>18</b>
<b>04</b> .....	<b>18</b>
<b>05</b> .....	<b>18</b>
<b>06</b> .....	<b>18</b>
<b>07</b> .....	<b>18</b>
<b>08</b> .....	<b>18</b>
OSD: 10 SEC. CHANGE PASSWORD.....	18
SCAN:10 SEC. CONSOLE ON/OFF.....	18
ESC: QUIT ENTER: COMPLETE.....	18

TAB: NEXT    INSERT: EDIT.....	18
NEW PASSWORD COMPLETE.....	20
 <b>SYSTEM 02</b> .....	<b>21</b>
<b>Trouble Shooting</b> .....	<b>23</b>
General Problems.....	23
Monitor/Video Problems.....	24
Keyboard Problems.....	24
PS/2 Mouse Problems.....	25
Problems with computers using serial mouse output...	27
Problems with power supply.....	28
<b>Specification</b> .....	<b>29</b>

# Introduction

---

The DKVM-8E gives you the ultimate in control of 8 PCs from one keyboard, mouse and monitor. To expand control ability, the Daisy-Chain allows eight DKVM-8E stack up for control 64 PCs from one keyboard, mouse and monitor. OSD (On-Screen Display) menu provides human friendly interface for naming each PCs and selecting one of them.

## Product Feature

---

- Allows users to control eight computers from one keyboard, mouse and monitor
- No software required, each channel contains a microprocessor emulation to intelligently manage the boot-up process for all your attached PCs boot-up transparently and simultaneously.
- Daisy-Chain ports allows control over as many as 64 computers through 8 banks of DKVM-8E units
- Hot plug—Add PCs or remove connected PCs for maintenance without powering down the KVM Switch or PCs
- No DIP-switch setting needed and auto detect daisy chain bank.
- On-Screen Display menu gives the user a visual interface to name and select computers
- Supports eight characters password protection and search PC Server name.
- Switches PCs by On-Screen Display, push button or keyboard “Hot Key” commands

- AutoScan mode for even more convenience
- Audible feedback when switching
- Recalls CAPS LOCK, NUM LOCK and SCROLL LOCK keys' status for each computer automatically
- Supports VGA, SVGA and MultiSync monitors
- Supports up to 1920 x 1440 resolution, 200MHz Bandwidth.
- Integrated mouse conversion technology allows connection of AT type computers that have serial mouse ports while using a PS/2 mouse only at console
- Keyboard and mouse emulation for error-free boot ups
- Microsoft® IntelliMouse®, Microsoft Intellimouse Explorer support and emulation
- Supports both AT and PS/2 type keyboards (AT requires AT - PS/2 adapter)
- User inexpensive and commonly found standard cables

## **Package Content**

---

Before you begin to install your DKVM-8E, please make sure that you received the following materials as listed below:

<b>Item</b>	<b>Qty</b>	<b>Remark</b>
DKVM-8E	1 pcs.	Keyboard, mouse & monitor switch
Power Adapter	1 pcs.	DC12V,1A
3 in 1 KVM cable kit	3 sets	1 set : 3 feet 3-in-one Cable Kit to daisy chain 2 sets : 6 feet 3-in-one Cable Kit to PC
Mouse Adapter cable	4 pcs	DB-9 to 6-pin Mini-DIN
User's Manual	1 pcs.	This manual
Rack mount bracket	2 pcs.	
Screw	8 pcs.	
Rubber foot	4 pcs.	

# Hardware Installation

---

This section will explain how to connect the console and the computers to the DKVM-4 switch unit. First the layout of front and rear panel will be shown.

## Front Panel Layout

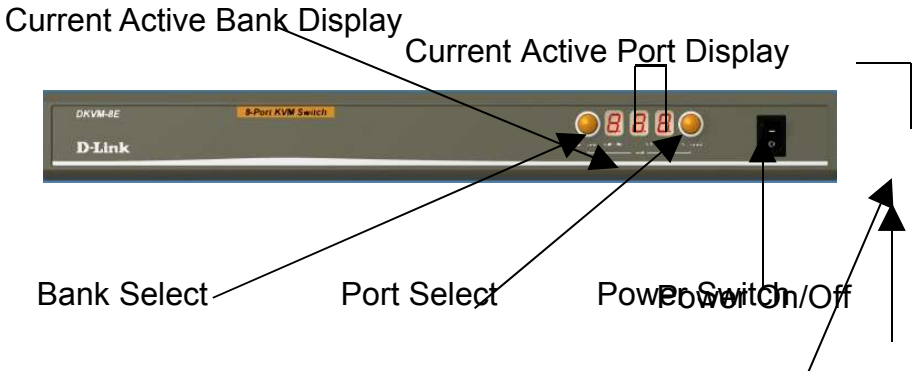



# Real Panel Layout

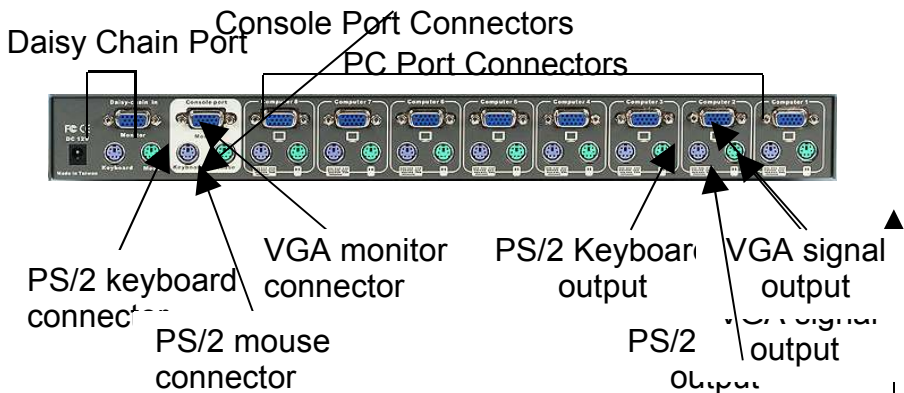

## Installation

### **WARNING!**

Before attempting to connect anything to the DKVM-8E or the computers, make sure everything is powered off. Otherwise, plugging and unplugging cables may cause irreversible damage to your computers and the DKVM-8E.

Please follow the steps below closely and in the order as shown, otherwise, keyboard and/or mouse errors may occur.

### Step 1



...ce to put your DKVM-8E. Its 19" rack  
...akes it ideal mountable on 19" rack.  
... rack, attach the included brackets to  
... the sides of the DKVM-8E. Take note of the length of your  
... cables so that your computers, DKVM-8E, keyboard,  
... mouse and monitor are distanced properly.

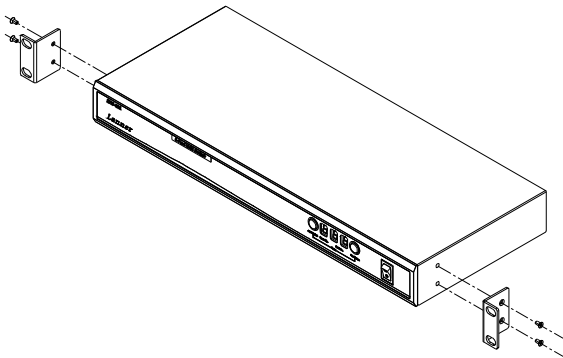

## Step 2

Connect the monitor to the DKVM-8E. Using the attached cable, or the one included with your monitor, connect it to the HD DB-15 female port on the back of the DKVM-8E labeled with the monitor symbol at the CONSOLE connector.



### Step 3

Connect the keyboard to the DKVM-8E. If you have an AT type keyboard, you will need an AT to PS/2 adapter.



### Step 4

Connect the mouse to the DKVM-8E.

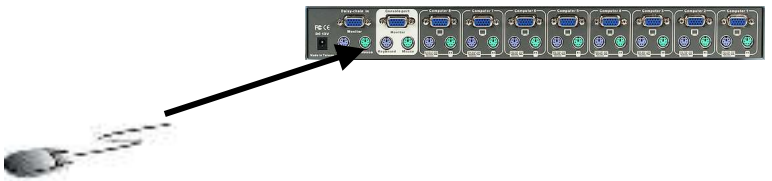

### Step 5

Now the PC connections will be made with the monitor (VGA) connections first. Connect a VGA cable (15-pin HDDB Male / Male) with the Male side to both of the PC and the rear panel of the DKVM-8E unit to the connector

labeled VGA. Repeat this for all PCs.

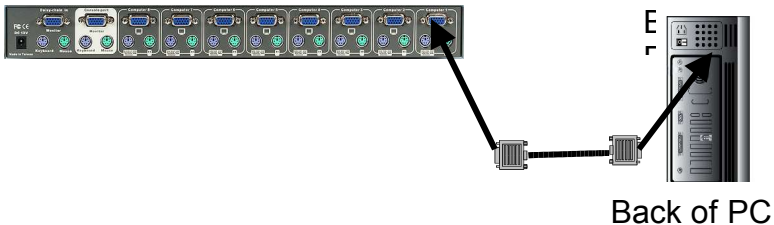

### Step 6

Connect the first computer's mouse cable to the DKVM-8E. If using a PS/2 cable, connect one end to the PS/2 mouse port on the computer, and the other end to the PC1 PS/2 mouse port on the back of DKVM-8E. If using a serial mouse cable, connect one end to a DB-9 serial port on the computer, and the other end to the PC1 DB-9 serial mouse port on the back of the DKVM-8E.

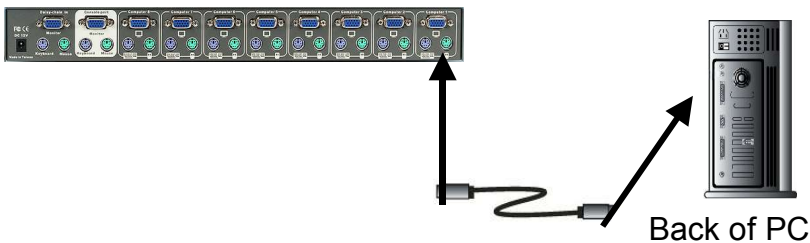

### Step 7

Connect the first computer's keyboard cable to the DKVM-8E. Using another PS/2 cable connect one end to PS/2 keyboard port on the computer, and the other end to the PC1 keyboard port on the back of DKVM-8E. If your

computer has an AT type keyboard port, you will need a PS/2 to AT keyboard adapter.

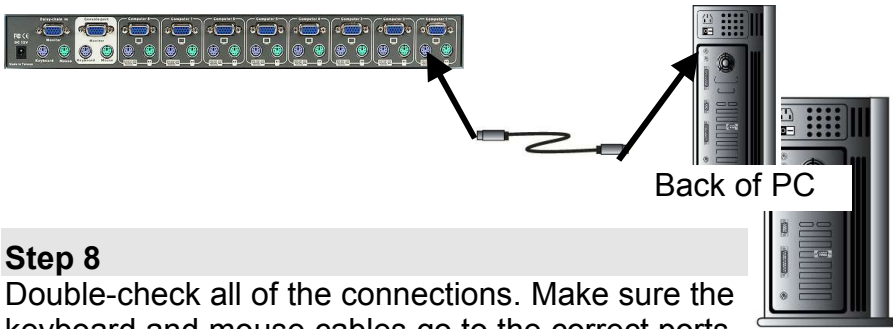

**Step 8**

Double-check all of the connections. Make sure the keyboard and mouse cables go to the correct ports.

**Step 9**

Repeat step 5 to 8 for the remainder of the computers.

**Step 10**

Attach the power supply to the DKVM-8E unit and plug the other end into an electrical receptacle. Now you will see the LED for Port 1 light up, and you will hear a beep. Switch on your monitor.

**NOTE:**

Please be remind to plug in power adapter. Although the PCs connected to DKVM-8E are able to support enough power to the stand alone switch, DKVM-8E still needs a power adapter for daisy chain more banks. If you forgot to plug in power adapter on the status of daisy chain, it may cause the unpredictable behavior or shut down the PC.

**Step 11**

Now power up all computers simultaneously. The first computer will be shown on the monitor. You may check to see if the mouse, keyboard and monitor work after the system has booted up. If this is OK, use the “Select” button to choose the next computer and verify the functionality in the same way. If you find errors, recheck all cables for proper connections before going to the trouble shooting section of this manual.

**NOTE:**

Please don't switch the PC port (i.e. Don't press the push button of KVM switch or run hot key) while the computers are under their boot-up process.

Normally, during boot-up process, each PC will communicate with the keyboard and mouse. If you switch PC ports on the KVM at this moment, it will cause communication errors or initialization failures between PC and keyboard or mouse.

# Usage

## The power on state of DKVM-8E

When you power on KVM switch, it will ask for the password, the default password value is eight zero – “00000000 “. Please key in eight zero and enter the same value at retype field.

### Note:

Before you are not familiar with the operation of OSD manual, please don't change the password – i.e. keep the default eight zero (00000000) value. Otherwise, if you have set the password and unfortunately forget the password, **you will need to contact supplier (D-Link) to have the unit re-set.**

## The Push Buttons

Pressing the button cyclically through all the ports.

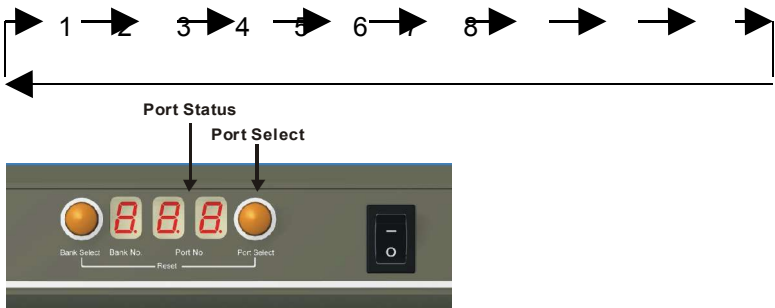

## Display LED Indication

You can press the button in order like mentioned-above diagram. When you select one of eight PC ports and this PC is shut down or this PC port is disconnected to the PC, the display LED of selected port will flash. When you select one of eight PCs ports and this PC is powered on, the selected port LED is lit.

## Reset Button

To press select and bank button of bank 1 (master) simultaneously can reset KVM switch. This reset action will not only return KVM switch back to initial state --- Check the password, but also re-check all of slave banks which connected to mast DKVM-8E.

If you add a new DKVM-8E as a slave bank, please use reset button of master DKVM-8E to assign a new ID to it. You can view this new slave bank go through OSD menu. With reset command, the PC ports of DKVM-8E will not be reset. Only power off DKVM-8E can reset PC ports.

## Keyboard Hot Key Commands

You can also conveniently command DKVM-8E by switching ports through simple key sequences. To send commands to DKVM-8E, the "SCROLL LOCK" key must be pressed twice within 2 seconds. You will hear a beep for confirmation and the keyboard is in hot key mode. If you have not pressed any key in hot key mode within 2 seconds (It means to key in any key follows up "Scroll



Lock” “Scroll Lock” key), the keyboard will back to under Operation System control state.

## Below are the different hot key commands

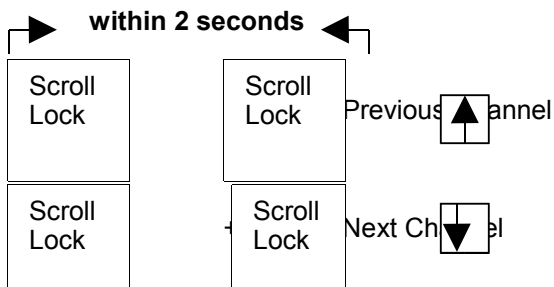

### Note:

You also could press “up arrow key” or “down arrow key” to speed up selecting the destination port)

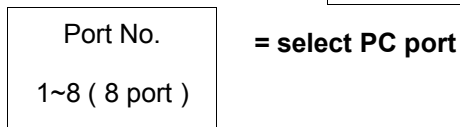
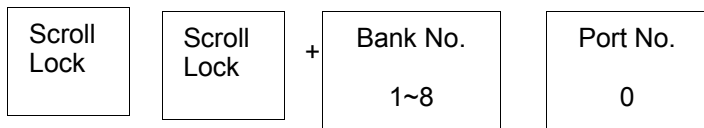
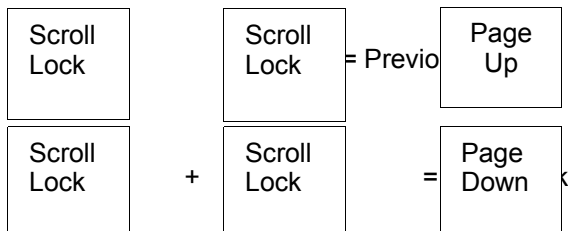

**Note:**

Bank no. and port no. selection must be made using the numeric keys on the keyboard. Numeric keys on the keypad are not available as a hot key command.

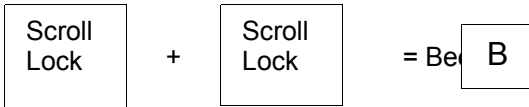
**Note:**

The default Beeper function is ON

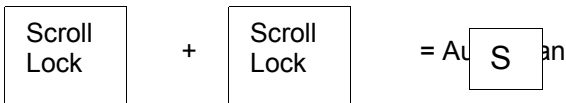
**Note:**

1. If you set up scan mode command already, DKVM-8E issue one beeper for confirmation every time when one of PC ports hop to next PC port.
2. To get out of Auto Scan Mode, press any key or SPACE bar.

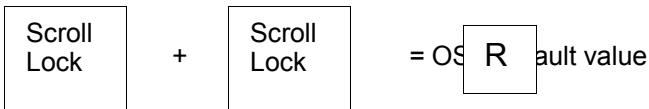
**ROM REFLASH****Note:**

1. Rom re-flash command need take 1~2 minutes.
2. The password is not included in this re-flash.

Scroll Lock + Scroll Lock = Search F the same PC name



**Note:**

Search PC name starting from 1<sup>st</sup> PC port

Scroll Lock + Scroll Lock space bar = On Screen Display Manual

## Daisy Chain Diagram

Please follow the steps below closely to daisy chain DKVM-8E. You can daisy chain up to 8 DKVM-8Es.

1. Connect Keyboard, Mouse and Monitor to the console port (white color block) of bank 1 KVM switch.
2. Use one end of 3-in-one Cable Kit to connect the daisy chain port of bank 1 and the other end for the console port (white color block) of bank 2 KVM switch.
3. Please repeat item B to daisy chain more bank as you want. But, the maximum daisy chain bank is eight

levels.

Please use the attached 3 feet 3-in-one Cable Kit to daisy chain the KVM Switches.

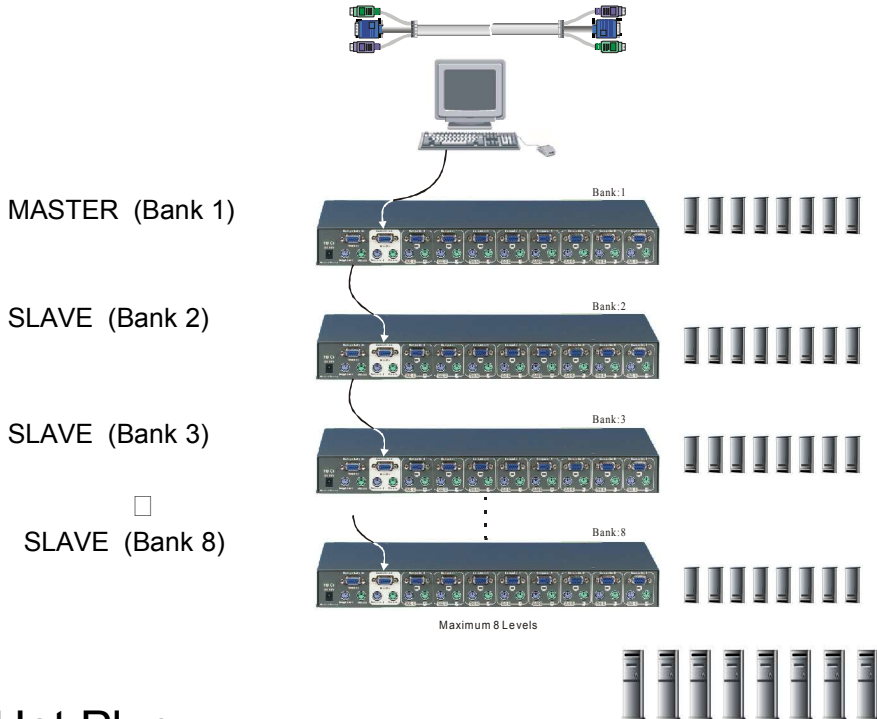

## Hot Plug

The DKVM-8E supports “Hot Plug” function for easy addition or removal of PCs. The user can arrange or maintain PCs as follows:

1. A PC can be disconnected and reconnected to the same or different port of the DKVM-8E without having to power it off as long as it is not the Daisy-chain port

or pass through port.

2. When the pass through port is active and selected, you must switch to a different port before you change the configuration, and then you can switch back to the pass through port.
3. You may unplug the mouse or the keyboard from the console port and plug it back in at any time.

**NOTE:**

Some O.S. (Operation Systems) like SCO Unix are unable to support “ Hot Plug ” function. If you apply “Hot Plug” to this kind of O.S., it will cause unpredictable behavior or shut down the PC. Before attempting to use “ Hot Plug ” , please make sure your O.S. and software driver supports the “Hot Plug” function.

# On Screen Display Operation

When you pop up the OSD manual window go through the hot key, you will see the following small window on your monitor.

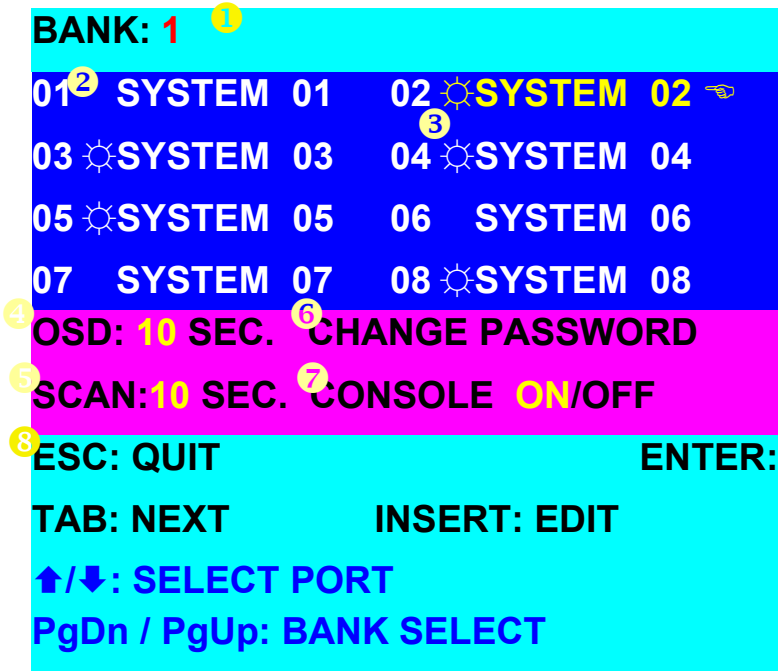

**1** The 1<sup>ST</sup> line bar is Bank no.

**2** The 2<sup>nd</sup> block is your PC system name list. You will find the system number list from 01 to 08. You can define your PC name in maximum 8 characters. The factory

default of 8 port KVM switch PC name is from “SYSTEM 01”, “SYSTEM 02”,..., “SYSTEM 08”.

③ The sun symbol “☀” beside the PC name shows that the respective PC system is powered on.

④ The “OSD: 10 SEC” means that the OSD windows display or PC system name exists 10 sec. on your monitor. You can modify it from 05 sec to 99 sec. The factory default value is 10 sec.

⑤ “SCAN TIME” is the scan interval from one PC port hopped to the next PC port. The default SCAN time is 10 sec and the maximum scan time is 99 sec.

⑥ “CHANGE PASSWORD” allows the user to change the password used to access all PC systems connected. The default password is 8 digits “00000000”.

**ENTER PASSWORD :** 

**ESC: QUIT**

**ENTER :**

There is an enter password window showed out when you select this item and then press the Enter. The maximum password is eight digits. After you key in the password and press the Enter key, there is another window for confirming your typed password.

<b>ENTER NEW PASSWORD:</b>	
<b>ESC: QUIT</b>	<b>ENTER :</b>
<b>RETYPE NEW PASSWORD:</b>	
<b>ESC: QUIT</b>	<b>ENTER :</b>

You need to retype the password again for rechecking your previous key-in password is matched or not.

<b>NEW PASSWORD COMPLETE</b>	
<b>ESC: QUIT</b>	<b>ENTER : COMPLETE</b>

⑦ “CONSOLE ON/OFF“ lets you select the console access of the KVM switch. If you select “CONSOLE ON“, any user can use the console. If you select “CONSOLE OFF“(factory default is OFF state), a password must be entered to use the console. When you enter the password and pass the KVM switch authentication, the CONSOLE will be set to ON. After you finish using the KVM switch, please do not forget to set the CONSOLE ON state to OFF for password authentication.

**Note:**

If you reset the KVM switch, or there is a power failure, the CONSOLE will be set at the OFF state.



⑧ To use up arrow key “↑” or down arrow key “↓” to select port for destination PC name. After you have selected the PC port already, you can press the ENTER Key to switch the PC port you want immediately

To use “PgUp” key or “PgDn” key for selecting previous or next Bank no. (or Box No.)

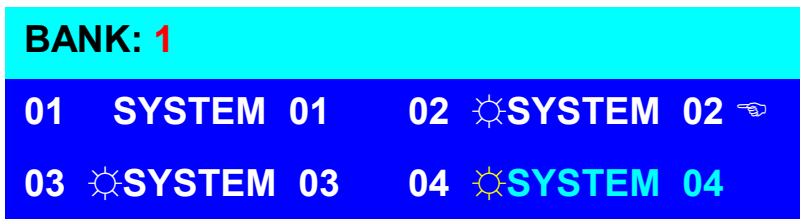

Press “INS” key for editing PC name. When editing is finished, press the “Enter” key to save the information.

To use “Tab” key to select items like Bank, OSD, SCAN, CHANGE PASSWORD, CONSOLE ON/OFF, etc...

When you finish the set up of PC name and get out of OSD setting mode, you will find the PC name showed at the up-left corner of monitor. Now you can use ESC key to clear the message right away if you don't need it.



If you want OSD returning back to factory default value, you can execute “SCROLL LOCK”, “SCROLL LOCK”, “R”

keys in order. The Display LEDs on the front panel will be flashed during the refresh process.

## **ROM REFLASH**

When the OSD value back to default setting, the Display LEDs on the front panel will stop flashing

# Trouble Shooting

---

## General Problems

**Q: The OSD menu does not display a “☀” on a channel where a computer is connected and powered up. What do I do?**

**A:** DKVM-8E will updated “☀” every 2 seconds. Using hot key to access the OSD menu again and it should have re-detected all the active channels.

**Q: When cascading the MASTER unit does not see the slave unit(s).**

**A:** Refer to the Installation section for information on how to properly connect the daisy-chain cable.

Make sure the daisy-chain cable that you are using is right. Using any other cable will not guarantee proper operation or video quality.

Reset the all slave unit first and then reset master unit to get the lost slave unit.

Although a power supply is not necessary to make the slave unit work, try adding a power supply.

# Monitor/Video Problems

**Q: I am getting ghosting shadowing or fuzzy images on my monitor. What do I do?**

**A:** `Check the cables and make sure they are inserted properly.

`Your resolution and / or refresh rate is extremely high, or your cable is too long. Replace your VGA cables with coaxial, double-shielded cables.

`Check to make sure that the power adapter is plugged in and is working properly. Make sure the power switch is on.

`Lower your refresh rate and / or screen resolution settings.

# Keyboard Problems

**Q: The keyboard is not detected, or a keyboard error is reported during boot-up.**

**A:** `Check the cables and make sure they are inserted properly in the correct channels.

`Check to make sure that the power adapter is plugged in and is working properly. Make sure the power switch is on.

`Do not press any keys on the keyboard while the

selected computer is booting up. This is true for any PC, whether stand-alone or connected to a DKVM-8E.

**Q: The computers boot up fine, but the keyboard does not work.**

**A:** `Check the cables and make sure they are inserted properly in the correct ports.

`Make sure the keyboard works when directly plugged into the computers.

`Try a different keyboard, but use only 101,102 or 104-key keyboards.

`Make sure that the keyboard driver is for 101, 102 or 104-key keyboards, and not old XT keyboards.

`Check to make sure that the power adapter is plugged in and is working properly. Make sure the power switch is on.

## PS/2 Mouse Problems

**Q: The mouse is not detected during boot-up.**

**A:** `Check the cables and make sure they are inserted properly in the correct ports.

`Check your computer / motherboard documentation making sure that the PS/2 mouse port (or IRQ) is

enabled.

- Make sure the mouse is directly plugged into the computer. Rebooting is necessary when trying this. If the computer still does not detect the mouse, then your computer's PS/2 mouse port has a problem.

**Q: The computer boot up fine, but the mouse does not work.**

- A:**
- Check the cables and make sure they are inserted properly in the correct ports.
  - Make sure the mouse works when plugged into the computer. Rebooting is necessary when trying this. If the mouse pointer still does not move, then either your PS/2 mouse port or the mouse itself has a problem.
  - Try a different mouse.
  - Make sure the mouse is a true PS/2 mouse. A combo mouse will work just as long as it is set for PS/2 mode with the correct adapter. A serial-only mouse with a combo mouse adapter WILL NOT work.
  - Check to make sure that the power adapter is plugged in and is working properly. Make sure the power switch is on.

**Q: When I switch from one port to another, mouse movement is completely erratic. What do I do?**

**A :** Switch the console port to the problem PC port and power on this PC again to get the mouse.

## Problems with computers using serial mouse output

**Note:**

The DKVM-8E has integrated mouse conversion technology. This technology converts the PS/2 mouse signals at the console to serial mouse signals.

**Q: The computers boot up fine, but the serial mouse port of PC does not work**

**A:** `Check the adapter and make sure they are inserted properly in the correct ports.

`Make sure the adapter pin out is right.

**Q: The wheel on the Mouse does not work on my computer. Why?**

**A:** `Make sure the mouse is fully compatible to Microsoft® Intellimouse® or Microsoft® Intellimouse® Explorer®.

`DKVM-8E does not support special wheel function of

mouse.

## Problems with power supply

**Q: The power switch is off, but the switch still works fine or power adapter**

**Is unplugged from the switch, but the switch still works fine ?**

**A:** DKVM-8E draws the power source from power adapter and PC's PS2 port. Some PC's PS2 port can support enough power for the switch, but some PC's PS2 port ( like laptop, notebook computer...etc.) is unable to supply enough power for the switch. In order to make sure the system can work steadily, please do not set power switch to off state or remove the power adapter from the switch.

Although the PCs connected to DKVM-8E are able to support enough power to the stand alone switch, DKVM-8E still needs a power adapter for daisy chain more banks.



# Specification

---

- Computer Connections : 8
- Display LED Indication: 3
- Keyboard : 6-pin Mini-DIN
- Mouse : 6-pin Mini-DIN
- Monitor : 15-pin HD DB type
- Cascade : Two 6-pin Mini-DIN + One 15-pin HDDB
  
- Cascade Port : 1
- On Screen Display : Yes
- 19" Rack Mount : Yes
- Cascade (Level) : 8
- Max. Access PCs : 64
- Manual Selection : Push Button
- Hot Key : Yes
- Switching Confirmation : Buzzer
- Keyboard state : Saved and Restored
- Keyboard : PS/2
- Mouse : PS/2
- Monitor : VGA, SVGA, XGA, MultiSync
- Display Data Channel : DDC1, DDC2B, DDC2AB
- Resolution : 1920 x 1440
- Bandwidth : 200M Hz
- Enclosure : Metal
- Storage (Celsius) : 0 ~ 70
- Dimension (LxWxH: mm) : 169mm\*410mm\*45mm
- Weight (g) : N/A
- Power Supply : DC 12V, 1A (AC power)

## LIMITED WARRANTY

D-Link provides this limited warranty for its product only to the person or entity who originally purchased the product from D-Link or its authorized reseller or distributor.

**Limited Hardware Warranty:** D-Link warrants that the hardware portion of the D-Link products described below (“Hardware”) will be free from material defects in workmanship and materials from the date of original retail purchase of the Hardware, for the period set forth below applicable to the product type (“Warranty Period”) if the Hardware is used and serviced in accordance with applicable documentation; provided that a completed Registration Card is returned to an Authorized D-Link Service Office within ninety (90) days after the date of original retail purchase of the Hardware. If a completed Registration Card is not received by an authorized D-Link Service Office within such ninety (90) period, then the Warranty Period shall be ninety (90) days from the date of purchase.

<b><i>Product Type</i></b>	<b><i>Warranty Period</i></b>
Product (excluding power supplies and fans)	One (1) Year
Power Supplies and Fans	One (1) Year
Spare parts and spare kits	Ninety (90) days

D-Link’s sole obligation shall be to repair or replace the defective Hardware at no charge to the original owner. Such repair or replacement will be rendered by D-Link at an Authorized D-Link Service Office. The replacement Hardware need not be new or of an identical make, model or part; D-Link may in its discretion may replace the defective Hardware (or any part thereof) with any reconditioned product that D-Link reasonably determines is substantially equivalent (or superior) in all material respects to the defective Hardware. The Warranty Period shall extend for an additional ninety (90) days after any repaired or replaced Hardware is delivered. If a material defect is incapable of correction, or if D-Link determines in its sole discretion that it is not practical to repair or replace the defective Hardware, the price paid by the original purchaser for the defective Hardware will be refunded by D-Link upon return to D-Link of the defective Hardware. All Hardware (or part thereof) that is replaced by D-Link, or for which the purchase price is refunded, shall become the property of D-Link upon replacement or refund.

**Limited Software Warranty:** D-Link warrants that the software portion of the product (“Software”) will substantially conform to D-Link’s then current functional specifications for the Software, as set forth in the applicable documentation, from the date of original delivery of the Software for a period of ninety (90) days (“Warranty Period”), if the Software is properly installed on approved hardware and operated as contemplated in its documentation. D-Link further warrants that, during the Warranty Period, the magnetic media on which D-Link delivers the Software will be free of physical defects. D-Link’s sole obligation shall be to replace the non-conforming Software (or defective media) with software that substantially conforms to D-Link’s functional specifications for the Software. Except as otherwise agreed by D-Link in writing, the replacement Software is provided only to the original licensee, and is subject to the terms and conditions of the license granted by D-Link for the Software. The Warranty Period shall extend for an additional ninety (90) days after any

replacement Software is delivered. If a material non-conformance is incapable of correction, or if D-Link determines in its sole discretion that it is not practical to replace the non-conforming Software, the price paid by the original licensee for the non-conforming Software will be refunded by D-Link; provided that the non-conforming Software (and all copies thereof) is first returned to D-Link. The license granted respecting any Software for which a refund is given automatically terminates.

***What You Must Do For Warranty Service:***

**Registration Card.** The Registration Card provided at the back of this manual must be completed and returned to an Authorized D-Link Service Office for each D-Link product within ninety (90) days after the product is purchased and/or licensed. The addresses/telephone/fax list of the nearest Authorized D-Link Service Office is provided in the back of this manual. FAILURE TO PROPERLY COMPLETE AND TIMELY RETURN THE REGISTRATION CARD MAY AFFECT THE WARRANTY FOR THIS PRODUCT.

**Submitting A Claim.** Any claim under this limited warranty must be submitted in writing before the end of the Warranty Period to an Authorized D-Link Service Office. The claim must include a written description of the Hardware defect or Software nonconformance in sufficient detail to allow D-Link to confirm the same. The original product owner must obtain a Return Material Authorization (RMA) number from the Authorized D-Link Service Office and, if requested, provide written proof of purchase of the product (such as a copy of the dated purchase invoice for the product) before the warranty service is provided. After an RMA number is issued, the defective product must be packaged securely in the original or other suitable shipping package to ensure that it will not be damaged in transit, and the RMA number must be prominently marked on the outside of the package. The packaged product shall be insured and shipped to D-Link, 53 Discovery Drive, Irvine CA 92618, with all shipping costs prepaid. D-Link may reject or return any product that is not packaged and shipped in strict compliance with the foregoing requirements, or for which an RMA number is not visible from the outside of the package. The product owner agrees to pay D-Link's reasonable handling and return shipping charges for any product that is not packaged and shipped in accordance with the foregoing requirements, or that is determined by D-Link not to be defective or non-conforming.

***What Is Not Covered:***

This limited warranty provided by D-Link does not cover:

Products that have been subjected to abuse, accident, alteration, modification, tampering, negligence, misuse, faulty installation, lack of reasonable care, repair or service in any way that is not contemplated in the documentation for the product, or if the model or serial number has been altered, tampered with, defaced or removed; Initial installation, installation and removal of the product for repair, and shipping costs;

Operational adjustments covered in the operating manual for the product, and normal maintenance;

Damage that occurs in shipment, due to act of God, failures due to power surge, and cosmetic damage; and

Any hardware, software, firmware or other products or services provided by anyone

other than D-Link.

**Disclaimer of Other Warranties:** EXCEPT FOR THE LIMITED WARRANTY SPECIFIED HEREIN, THE PRODUCT IS PROVIDED “AS-IS” WITHOUT ANY WARRANTY OF ANY KIND INCLUDING, WITHOUT LIMITATION, ANY WARRANTY OF MERCHANTABILITY, FITNESS FOR A PARTICULAR PURPOSE AND NON-INFRINGEMENT. IF ANY IMPLIED WARRANTY CANNOT BE DISCLAIMED IN ANY TERRITORY WHERE A PRODUCT IS SOLD, THE DURATION OF SUCH IMPLIED WARRANTY SHALL BE LIMITED TO NINETY (90) DAYS. EXCEPT AS EXPRESSLY COVERED UNDER THE LIMITED WARRANTY PROVIDED HEREIN, THE ENTIRE RISK AS TO THE QUALITY, SELECTION AND PERFORMANCE OF THE PRODUCT IS WITH THE PURCHASER OF THE PRODUCT.

**Limitation of Liability:** TO THE MAXIMUM EXTENT PERMITTED BY LAW, D-LINK IS NOT LIABLE UNDER ANY CONTRACT, NEGLIGENCE, STRICT LIABILITY OR OTHER LEGAL OR EQUITABLE THEORY FOR ANY LOSS OF USE OF THE PRODUCT, INCONVENIENCE OR DAMAGES OF ANY CHARACTER, WHETHER DIRECT, SPECIAL, INCIDENTAL OR CONSEQUENTIAL (INCLUDING, BUT NOT LIMITED TO, DAMAGES FOR LOSS OF GOODWILL, WORK STOPPAGE, COMPUTER FAILURE OR MALFUNCTION, LOSS OF INFORMATION OR DATA CONTAINED IN, STORED ON, OR INTEGRATED WITH ANY PRODUCT RETURNED TO D-LINK FOR WARRANTY SERVICE) RESULTING FROM THE USE OF THE PRODUCT, RELATING TO WARRANTY SERVICE, OR ARISING OUT OF ANY BREACH OF THIS LIMITED WARRANTY, EVEN IF D-LINK HAS BEEN ADVISED OF THE POSSIBILITY OF SUCH DAMAGES. THE SOLE REMEDY FOR A BREACH OF THE FOREGOING LIMITED WARRANTY IS REPAIR, REPLACEMENT OR REFUND OF THE DEFECTIVE OR NON-CONFORMING PRODUCT.

**GOVERNING LAW:** This Limited Warranty shall be governed by the laws of the state of California.

Some states do not allow exclusion or limitation of incidental or consequential damages, or limitations on how long an implied warranty lasts, so the foregoing limitations and exclusions may not apply. This limited warranty provides specific legal rights and the product owner may also have other rights which vary from state to state.

## **Trademarks**

Copyright ©1999 D-Link Corporation. Contents subject to change without prior notice. D-Link is a registered trademark of D-Link Corporation/D-Link Systems, Inc. All other trademarks belong to their respective proprietors.

## **Copyright Statement**

No part of this publication may be reproduced in any form or by any means or used to make any derivative such as translation, transformation, or adaptation

without permission from D-Link Corporation/D-Link Systems Inc., as stipulated by the United States Copyright Act of 1976.

## **FCC Certifications**

This equipment has been tested and found to comply with the limits for a Class B digital device, pursuant to Part 15 of the FCC Rules. These limits are designed to provide reasonable protection against harmful interference in a residential installation. This equipment generates, uses and can radiate radio frequency energy and, if not installed and used in accordance with the instructions, may cause harmful interference to radio communications. However, there is no guarantee that interference will not occur in a particular installation. If this equipment does cause harmful interference to radio or television reception, which can be determined by turning the equipment off and on, the user is encouraged to try to correct the interference by one or more of the following measures:

- Reorient or relocate the receiving antenna.
- Increase the separation between the equipment and receiver.
- Connect the equipment into an outlet on a circuit different from that to which the receiver is connected.
- Consult the dealer or an experienced radio/TV technician for help.

Shielded interface cables must be used in order to comply with emission limits.

You are cautioned that changes or modifications not expressly approved by the party responsible for compliance could void your authority to operate the equipment.

This device complies with Part 15 of the FCC rules. Operation is subject to the following two conditions:

(1) This device may not cause harmful interference, and (2) This device must accept any interference received, including interference that may cause undesired operation.

## **CE Mark Warning**

This is a Class B product. In a domestic environment, this product may cause radio

## D-Link Offices

### AUSTRALIA

#### D-LINK AUSTRALIA

Unit 16, 390 Eastern Valley Way, Roseville, NSW 2069, Australia  
TEL: 61-2-9417-7100 FAX: 61-2-9417-1077  
TOLL FREE: 1800-177-100 (Australia), 0800-900900 (New Zealand)  
E-MAIL: [support@dlink.com.au](mailto:support@dlink.com.au), [info@dlink.com.au](mailto:info@dlink.com.au) URL: [www.dlink.com.au](http://www.dlink.com.au)

### BENELUX

#### D-LINK BENELUX

Fellenoord 130, 5611 ZB Eindhoven, The Netherlands  
TEL: 31-40-2668713 FAX: 31-40-2668666  
E-MAIL: [info@dlink-benelux.nl](mailto:info@dlink-benelux.nl), [info@dlink-benelux.be](mailto:info@dlink-benelux.be) URL: [www.dlink-benelux.nl/](http://www.dlink-benelux.nl/), [www.dlink-benelux.be/](http://www.dlink-benelux.be/)

### CANADA

#### D-LINK CANADA

#2180 Winston Park Drive, Oakville, Ontario, L6H 5W1 Canada  
TEL: 1-905-829-5033 FAX: 1-905-829-5095 FREE CALL: 1-800-354-6522  
E-MAIL: [techsup@dlink.ca](mailto:techsup@dlink.ca) URL: [www.dlink.ca](http://www.dlink.ca) FTP: <ftp://ftp.dlinknet.com>

### CHILE

#### D-LINK SOUTH AMERICA

Isidora Goyechea 2934 of 702, Las Condes, Santiago – Chile S.A.  
TEL: 56-2-232-3185 FAX: 56-2-232-0923  
E-MAIL: [ccasassu@dlink.cl](mailto:ccasassu@dlink.cl), [tsilva@dlink.cl](mailto:tsilva@dlink.cl) URL: [www.dlink.cl](http://www.dlink.cl)

### CHINA

#### D-LINK CHINA

2F, Sigma Building, 49 Zhichun Road, Haidian District, 100080 Beijing, China  
TEL: 86-10-88097777 FAX: 86-10-88096789

### DENMARK

#### D-LINK DENMARK

Naverland 2, DK-2600 Glostrup, Copenhagen, Denmark  
TEL: 45-43-969040 FAX: 45-43-424347

E-MAIL: [info@dlink.dk](mailto:info@dlink.dk) URL: [www.dlink.dk](http://www.dlink.dk)

### EGYPT

#### D-LINK MIDDLE EAST

7 Assem Ebn Sabet Street, Heliopolis Cairo, Egypt

TEL: 202-2456176 FAX: 202-2456192  
E-MAIL: [support@dlink-me.com](mailto:support@dlink-me.com) URL: [www.dlink-me.com](http://www.dlink-me.com)

### FINLAND

#### D-Link FINLAND

Thlli-ja Pakkahuone Katajanoklaituri 5, FIN-00160 Helsinki, Finland

TEL: 358-9-622-91660 FAX: 358-9-622-91661

E-MAIL: [info@dlink-fi.com](mailto:info@dlink-fi.com) URL: [www.dlink-fi.com](http://www.dlink-fi.com)

### FRANCE

#### D-LINK FRANCE

Le Florilege #2, Allée de la Fresnerie, 78330 Fontenay le Fleury France

TEL: 33-1-302-38688 FAX: 33-1-3023-8689

E-MAIL: [info@dlink-france.fr](mailto:info@dlink-france.fr) URL: [www.dlink-france.fr](http://www.dlink-france.fr)

### GERMANY

#### D-LINK Central Europe/D-Link Deutschland GmbH

Schwalbacher Strasse 74, D-65760 Eschborn, Germany

TEL: 49-6196-77990 FAX: 49-6196-7799300

INFO LINE: 00800-7250-0000 (toll free) HELP LINE: 00800-7250-4000 (toll free)

REPAIR LINE: 00800-7250-8000

E-MAIL: [info@dlink.de](mailto:info@dlink.de) URL: [www.dlink.de](http://www.dlink.de)

### IBERIA

#### D-LINK IBERIA

Gran Via de Carlos III, 84, 3º Edificio Trade, 08028 BARCELONA

TEL: 34 93 4090770 FAX 34 93 4910795

E-MAIL: [info@dlinkiberia.es](mailto:info@dlinkiberia.es) URL: [www.dlinkiberia.es](http://www.dlinkiberia.es)

### INDIA

#### D-LINK INDIA

Plot No.5, Kuria-Bandra Complex Road, Off Cst Road, Santacruz (E), Bombay - 400 098 India

TEL: 91-22-652-6696 FAX: 91-22-652-8914

E-MAIL: [service@dlink.india.com](mailto:service@dlink.india.com) URL: [www.dlink-india.com](http://www.dlink-india.com)

### ITALY

#### D-LINK ITALIA

Via Nino Bonnet No. 6/b, 20154 Milano, Italy

TEL: 39-02-2900-0676 FAX: 39-02-2900-1723

E-MAIL: [info@dlink.it](mailto:info@dlink.it) URL: [www.dlink.it](http://www.dlink.it)

### JAPAN

#### D-LINK JAPAN

10F, 8-8-15 Nishi-Gotanda, Shinagawa-ku, Tokyo 141, Japan

TEL: 81-3-5434-9678 FAX: 81-3-5434-9868

E-MAIL: [kida@d-link.co.jp](mailto:kida@d-link.co.jp) URL: [www.d-link.co.jp](http://www.d-link.co.jp)

### NORWAY

#### D-LINK NORWAY

Waldemar Thranesgt. 77, 0175 Oslo, Norway

TEL: 47-22-991890 FAX: 47-22-207039

### RUSSIA

#### D-LINK RUSSIA

Michurinski Prospekt 49, 117607 Moscow, Russia

TEL: 7-095-737-3389, 7-095-737-3492 FAX: 7-095-737-3390

E-MAIL: [vl@dlink.ru](mailto:vl@dlink.ru) URL: [www.dlink.ru](http://www.dlink.ru)

### SINGAPORE

#### D-LINK INTERNATIONAL

1 International Business Park, #03-12 The Synergy, Singapore 609917

TEL: 65-774-6233 FAX: 65-774-6322

E-MAIL: [info@dlink.com.sg](mailto:info@dlink.com.sg) URL: [www.dlink-intl.com](http://www.dlink-intl.com)

### S. AFRICA

#### D-LINK SOUTH AFRICA

102-106 Witchazel Avenue, Einetein Park 2, Block B, Highveld Technopark Centurion, South Africa

TEL: 27(0)126652166 FAX: 27(0)126652186

E-MAIL: [atbe@d-link.co.za](mailto:atbe@d-link.co.za) URL: [www.d-link.co.za](http://www.d-link.co.za)

### SWEDEN

#### D-LINK SWEDEN

P.O. Box 15036, S-167 15 Bromma Sweden

TEL: 46-(0)8564-61900 FAX: 46-(0)8564-61901

E-MAIL: [info@dlink.se](mailto:info@dlink.se) URL: [www.dlink.se](http://www.dlink.se)

### TAIWAN

#### D-LINK TAIWAN

2F, No. 119 Pao-Chung Road, Hsin-Tien, Taipei, Taiwan,

TEL: 886-2-2910-2626 FAX: 886-2-2910-1515

E-MAIL: [dsusa@tw.dlinktw.com.tw](mailto:dsusa@tw.dlinktw.com.tw) URL: [www.dlinktw.com.tw](http://www.dlinktw.com.tw)

### U.K.

#### D-LINK EUROPE

4<sup>th</sup> Floor, Merit House, Edgware Road, Colindale, London, NW9 5AB, U.K.

TEL: 44-20-8731-5555 FAX: 44-20-8731-5511

E-MAIL: [info@dlink.co.uk](mailto:info@dlink.co.uk) URL: [www.dlink.co.uk](http://www.dlink.co.uk)

### U.S.A.

#### D-LINK U.S.A.

53 Discovery Drive, Irvine, CA 92618 USA

TEL: 1-949-788-0805 FAX: 1-949-753-7033 INFO LINE: 1-800-326-1688

BBS: 1-949-455-1779, 1-949-455-9616  
E-MAIL: [tech@dlink.com](mailto:tech@dlink.com), [support@dlink.com](mailto:support@dlink.com) URL: [www.dlink.com](http://www.dlink.com)

# Registration Card

*Print, type or use block letters.*

Your name: Mr./Ms \_\_\_\_\_

Organization: \_\_\_\_\_ Dept. \_\_\_\_\_

Your title at organization: \_\_\_\_\_

Telephone: \_\_\_\_\_ Fax: \_\_\_\_\_

Organization's full address: \_\_\_\_\_

Country: \_\_\_\_\_

Date of purchase (Month/Day/Year): \_\_\_\_\_

Product Model	Product Serial No.	* Product installed in type of computer (e.g., Compaq 486)	* Product installed in computer serial No.

(\* Applies to adapters only)

*Product was purchased from:*

Reseller's name: \_\_\_\_\_

Telephone: \_\_\_\_\_ Fax: \_\_\_\_\_

Reseller's full address: \_\_\_\_\_

**Answers to the following questions help us to support your product:**

**1. Where and how will the product primarily be used?**

Home  Office  Travel  Company Business  Home Business  Personal Use

**2. How many employees work at installation site?**

1 employee  2-9  10-49  50-99  100-499  500-999  1000 or more

**3. What network protocol(s) does your organization use ?**

XNS/IPX  TCP/IP  DECnet  Others \_\_\_\_\_

**4. What network operating system(s) does your organization use ?**

D-Link LANsmart  Novell NetWare  NetWare Lite  SCO Unix/Xenix  PC NFS  3Com 3+Open  
 Banyan Vines  DECnet Pathwork  Windows NT  Windows NTAS  Windows '95  
 Others \_\_\_\_\_

**5. What network management program does your organization use ?**

D-View  HP OpenView/Windows  HP OpenView/Unix  SunNet Manager  Novell NMS  
 NetView 6000  Others \_\_\_\_\_

**6. What network medium/media does your organization use ?**

Fiber-optics  Thick coax Ethernet  Thin coax Ethernet  10BASE-T UTP/STP  
 100BASE-TX  100BASE-T4  100VGAnyLAN  Others \_\_\_\_\_

**7. What applications are used on your network?**

Desktop publishing  Spreadsheet  Word processing  CAD/CAM  
 Database management  Accounting  Others \_\_\_\_\_

**8. What category best describes your company?**

Aerospace  Engineering  Education  Finance  Hospital  Legal  Insurance/Real Estate  Manufacturing  
 Retail/Chainstore/Wholesale  Government  Transportation/Utilities/Communication  VAR  
 System house/company  Other \_\_\_\_\_

**9. Would you recommend your D-Link product to a friend?**

Yes  No  Don't know yet

**10. Your comments on this product?**

\_\_\_\_\_  
\_\_\_\_\_





**TO:** \_\_\_\_\_  
\_\_\_\_\_  
\_\_\_\_\_

**D-Link<sup>®</sup>**