

# **D-Link<sup>®</sup>**

## **DGS-1008D 8-Port 10/100/1000Mbps Switch**

### **Manual**



RECYCLABLE

V5.20

Information in this document is subject to change without notice.

© 2010 D-Link Corporation. All rights reserved.

Reproduction in any manner whatsoever without the written permission of D-Link Corporation is strictly forbidden.

Trademarks used in this text: *D-Link* and the *D-LINK* logo are trademarks of D-Link Corporation; *Microsoft* and *Windows* are registered trademarks of Microsoft Corporation.

Other trademarks and trade names may be used in this document to refer to either the entities claiming the marks and names or their products. D-Link Corporation disclaims any proprietary interest in trademarks and trade names other than its own.

#### FCC Warning

This equipment has been tested and found to comply with the limits for a Class B digital device, pursuant to Part 15 of the FCC Rules. These limits are designed to provide reasonable protection against harmful interference when the equipment is operated in a commercial environment. This equipment generates, uses, and can radiate radio frequency energy and, if not installed and used in accordance with this user's guide, may cause harmful interference to radio communications. Operation of this equipment in a residential area is likely to cause harmful interference in which case the user will be required to correct the interference at his own expense.

#### CE Mark Warning

This is a Class B product. In a domestic environment, this product may cause radio interference in which case the user may be required to take adequate measures.

#### Warnung!

Dies ist ein Produkt der Klasse B. Im Wohnbereich kann dieses Produkt Funkstörungen verursachen. In diesem Fall kann vom Benutzer verlangt werden, angemessene Massnahmen zu ergreifen.

#### Precaución!

Este es un producto de Clase B. En un entorno doméstico, puede causar interferencias de radio, en cuyo caso, puede requerirse al usuario para que adopte las medidas adecuadas.

#### Attention!

Ceci est un produit de classe B. Dans un environnement domestique, ce produit pourrait causer des interférences radio, auquel cas l'utilisateur devrait prendre les mesures adéquates.

#### Attenzione!

Il presente prodotto appartiene alla classe B. Se utilizzato in ambiente domestico il prodotto può causare interferenze radio, nel cui caso è possibile che l'utente debba assumere provvedimenti adeguati.

#### VCCI Warning

この装置は、クラスB情報技術装置です。この装置を家庭環境で使用すると電波妨害を引き起こすことがあります。この場合には使用者が適切な対策を講ずるよう要求されることがあります。

#### BSMI Warning

#### 警告使用者

這是乙類的資訊產品，在居住的環境中使用時，可能會造成射頻干擾，在這種情況下使用者會被要求採取某些適當的對策。

# CONTENTS

<b>INTRODUCTION</b> .....	<b>1</b>
ETHERNET TECHNOLOGY.....	1
<i>Fast Ethernet Technology</i> .....	1
<i>Gigabit Ethernet Technology</i> .....	1
802.1P AND QoS.....	1
<i>Advantages of QoS</i> .....	1
<i>Understanding QoS</i> .....	2
D-LINK'S GREEN TECHNOLOGY.....	2
SWITCHING TECHNOLOGY.....	2
SWITCH DESCRIPTION.....	3
<i>Features</i> .....	3
FRONT-PANEL COMPONENTS.....	3
<i>LED Indicators</i> .....	4
REAR PANEL DESCRIPTION.....	5
<b>INSTALLATION</b> .....	<b>6</b>
<i>Package Contents</i> .....	6
BEFORE YOU CONNECT TO THE NETWORK.....	6
MOUNTING THE SWITCH ON A WALL.....	7
POWER ON.....	7
<i>Power Failure</i> .....	7
<b>CONNECTING THE SWITCH</b> .....	<b>8</b>
SWITCH TO END NODE.....	8
SWITCH TO HUB OR SWITCH.....	8
CONNECTING TO NETWORK BACKBONE OR SERVER.....	9
<b>TECHNICAL SPECIFICATIONS</b> .....	<b>10</b>
<b>GLOSSARY</b> .....	<b>12</b>

## Preface

The *DGS-1008D Manual* is divided into sections that describe the system installation and operating instructions with examples.

**Section 1, Introduction** - A description of the physical features of the Switch, including LED indicators, ports and panel descriptions.

**Section 2, Installation** – A description of the physical installation of the Switch including connecting the Switch to the network and connecting stacked switch groups.

**Section 3, Connecting the Switch** – A description of how to connect your Switch to an end node, hub, Switch, or backbone server.

**Appendix A, Technical Specifications** - The technical specifications of the DGS-1008D.

**Glossary** – Lists definitions for terms and acronyms used in this document.

## Intended Readers

The *DGS-1008D Manual* contains information for setup and management and of the DGS-1008D Switch. This manual is intended for network managers familiar with network management concepts and terminology.

## Notes, Notices, and Cautions



**NOTE:** A NOTE indicates important information that helps you make better use of your device.



**NOTICE:** A NOTICE indicates either potential damage to hardware or loss of data and tells you how to avoid the problem.



**CAUTION:** A CAUTION indicates the potential for property damage, personal injury, or death.

# Safety Instructions

Use the following safety guidelines to ensure your own personal safety and to help protect your system from potential damage. Throughout this safety section, the caution icon (  ) is used to indicate cautions and precautions that you need to review and follow.



## Safety Cautions

To reduce the risk of bodily injury, electrical shock, fire, and damage to the equipment, observe the following precautions.

Observe and follow service markings. Do not service any product except as explained in your system documentation. Opening or removing covers that are marked with the triangular symbol with a lightning bolt may expose you to an electrical shock. Only a trained service technician should service components inside these compartments.

If any of the following conditions occur, unplug the product from the electrical outlet and replace the part or contact your trained service provider:

- The power cable, extension cable, or plug is damaged.
- An object has fallen into the product.
- The product has been exposed to water.
- The product has been dropped or damaged.
- The product does not operate correctly when you follow the operating instructions.
- Keep your system away from radiators and heat sources. Also, do not block cooling vents.
- Do not spill food or liquids on your system components, and never operate the product in a wet environment. If the system gets wet, see the appropriate section in your troubleshooting guide or contact your trained service provider.
- Do not push any objects into the openings of your system. Doing so can cause a fire or an electric shock by shorting out interior components.
- Use the product only with approved equipment.
- Allow the product to cool before removing covers or touching internal components.
- Operate the product only from the type of external power source indicated on the electrical ratings label. If you are not sure of the type of power source required, consult your service provider or local power company.
- To help avoid damaging your system, be sure the voltage selection switch (if provided) on the power supply is set to match the power available at your location:
  - 115 volts (V)/60 hertz (Hz) in most of North and South America and some Far Eastern countries such as South Korea and Taiwan.
  - 100 V/50 Hz in eastern Japan and 100 V/60 Hz in western Japan.
  - 230 V/50 Hz in most of Europe, the Middle East, and the Far East.
- Also be sure that attached devices are electrically rated to operate with the power available in your location.
- Use only approved power cable(s). If you have not been provided with a power cable for your system or for any AC-powered option intended for your system, purchase a power cable that is approved for use in your country. The power cable must be rated for the product and for the voltage and current marked on the product's electrical ratings label. The voltage and current rating of the cable should be greater than the ratings marked on the product.
- To help prevent an electric shock, plug the system and peripheral power cables into properly grounded electrical outlets. These cables are equipped with three-prong plugs to help ensure proper grounding. Do not use adapter plugs or remove the grounding prong from a cable. If you must use an extension cable, use a 3-wire cable with properly grounded plugs.
- Observe extension cable and power strip ratings. Make sure that the total ampere rating of all products plugged into the extension cable or power strip does not exceed 80 percent of the ampere ratings limit for the extension cable or power strip.
- To help protect your system from sudden, transient increases and decreases in electrical power, use a surge suppressor, line conditioner, or uninterruptible power supply (UPS).
- Position system cables and power cables carefully; route cables so that they cannot be stepped on or tripped over. Be sure that nothing rests on any cables.
- Do not modify power cables or plugs. Consult a licensed electrician or your power company for site modifications. Always follow your local/national wiring rules.

- When connecting or disconnecting power to hot-pluggable power supplies, if offered with your system, observe the following guidelines:
  - Install the power supply before connecting the power cable to the power supply.
  - Unplug the power cable before removing the power supply.
  - If the system has multiple sources of power, disconnect power from the system by unplugging all power cables from the power supplies.
- Move products with care; ensure that all casters and/or stabilizers are firmly connected to the system. Avoid sudden stops and uneven surfaces.



## General Precautions for Rack-Mountable Products

Observe the following precautions for rack stability and safety. Also refer to the rack installation documentation accompanying the system and the rack for specific caution statements and procedures.

Systems are considered to be components in a rack. Thus, "component" refers to any system as well as to various peripherals or supporting hardware.



**CAUTION:** Installing systems in a rack without the front and side stabilizers installed could cause the rack to tip over, potentially resulting in bodily injury under certain circumstances. Therefore, always install the stabilizers before installing components in the rack.

After installing system/components in a rack, never pull more than one component out of the rack on its slide assemblies at one time. The weight of more than one extended component could cause the rack to tip over and may result in serious injury.

- Before working on the rack, make sure that the stabilizers are secured to the rack, extended to the floor, and that the full weight of the rack rests on the floor. Install front and side stabilizers on a single rack or front stabilizers for joined multiple racks before working on the rack.
- Always load the rack from the bottom up, and load the heaviest item in the rack first.
- Make sure that the rack is level and stable before extending a component from the rack.
- Use caution when pressing the component rail release latches and sliding a component into or out of a rack; the slide rails can pinch your fingers.
- After a component is inserted into the rack, carefully extend the rail into a locking position, and then slide the component into the rack.
- Do not overload the AC supply branch circuit that provides power to the rack. The total rack load should not exceed 80 percent of the branch circuit rating.
- Ensure that proper airflow is provided to components in the rack.
- Do not step on or stand on any component when servicing other components in a rack.



**NOTE:** A qualified electrician must perform all connections to DC power and to safety grounds. All electrical wiring must comply with applicable local or national codes and practices.



**CAUTION:** Never defeat the ground conductor or operate the equipment in the absence of a suitably installed ground conductor. Contact the appropriate electrical inspection authority or an electrician if you are uncertain that suitable grounding is available.



**CAUTION:** The system chassis must be positively grounded to the rack cabinet frame. Do not attempt to connect power to the system until grounding cables are connected. Completed power and safety ground wiring must be inspected by a qualified electrical inspector. An energy hazard will exist if the safety ground cable is omitted or disconnected.

## **Protecting Against Electrostatic Discharge**

Static electricity can harm delicate components inside your system. To prevent static damage, discharge static electricity from your body before you touch any of the electronic components, such as the microprocessor. You can do so by periodically touching an unpainted metal surface on the chassis.

You can also take the following steps to prevent damage from electrostatic discharge (ESD):

1. When unpacking a static-sensitive component from its shipping carton, do not remove the component from the antistatic packing material until you are ready to install the component in your system. Just before unwrapping the antistatic packaging, be sure to discharge static electricity from your body.
2. When transporting a sensitive component, first place it in an antistatic container or packaging.
3. Handle all sensitive components in a static-safe area. If possible, use antistatic floor pads, workbench pads, and an antistatic grounding strap.

# SECTION 1

## Introduction

*Ethernet Technology*

*802.1p and QoS*

*D-Link's Green Technology*

*Switch Description*

*Features*

*Ports*

*Front-Panel Components*

## Ethernet Technology

### Fast Ethernet Technology

The growing importance of LANs and the increasing complexity of desktop computing applications are fueling the need for high performance networks. A number of high-speed LAN technologies are proposed to provide greater bandwidth and improve client/server response times. Among them, Fast Ethernet, or 100BASE-T, provides a non-disruptive, smooth evolution from 10BASE-T technology.

100Mbps Fast Ethernet is a standard specified by the IEEE 802.3 LAN committee. It is an extension of the 10Mbps Ethernet standard with the ability to transmit and receive data at 100Mbps, while maintaining the Carrier Sense Multiple Access with Collision Detection (CSMA/CD) Ethernet protocol.

### Gigabit Ethernet Technology

Gigabit Ethernet is an extension of IEEE 802.3 Ethernet utilizing the same packet structure, format, and support for CSMA/CD protocol, full duplex, flow control, and management objects, but with a tenfold increase in theoretical throughput over 100Mbps Fast Ethernet and a one hundred-fold increase over 10Mbps Ethernet. Since it is compatible with all 10Mbps and 100Mbps Ethernet environments, Gigabit Ethernet provides a straightforward upgrade without wasting a company's existing investment in hardware, software, and trained personnel.

The increased speed and extra bandwidth offered by Gigabit Ethernet are essential to coping with the network bottlenecks that frequently develop as computers and their buses get faster and more users use applications that generate more traffic. Upgrading key components, such as your backbone and servers to Gigabit Ethernet can greatly improve network response times as well as significantly speed up the traffic between your subnetworks.

Gigabit Ethernet enables fast optical fiber connections to support video conferencing, complex imaging, and similar data-intensive applications. Likewise, since data transfers occur 10 times faster than Fast Ethernet, servers outfitted with Gigabit Ethernet NIC's are able to perform 10 times the number of operations in the same amount of time.

In addition, the phenomenal bandwidth delivered by Gigabit Ethernet is the most cost-effective method to take advantage of today and tomorrow's rapidly improving switching and routing internetworking technologies.

### 802.1p and QoS

The DGS-1008D Switch supports 802.1p priority queuing Quality of Service. The implementation of QoS (Quality of Service) and benefits of using 802.1p priority queuing are described here.

### Advantages of QoS

QoS is an implementation of the IEEE 802.1p standard that allows network administrators a method of reserving bandwidth for important functions that require a large bandwidth or have a high priority, such as VoIP (voice-over Internet Protocol), web browsing applications, file server applications or video conferencing. Not only can a larger bandwidth be created, but other less critical traffic can be limited, so bandwidth can be saved. The Switch has separate hardware queues on every physical port to which packets from various applications are mapped to and assigned a priority. The illustration below shows how 802.1P priority queuing is implemented on the Switch. The eight IEEE 802.1P priority levels defined by the standard are mapped to the four class queues used in the Switch.



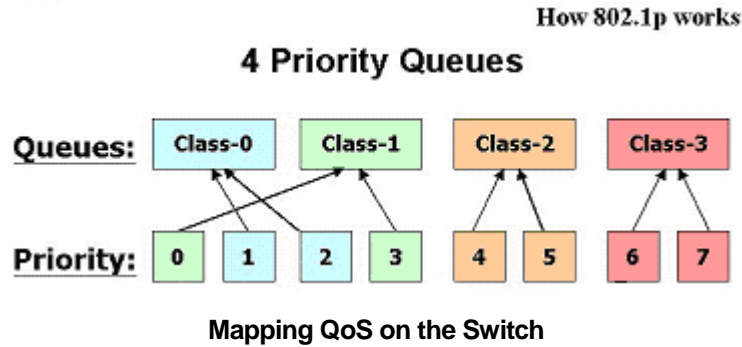

The picture above shows the default priority setting for the Switch. Class-3 has the highest priority of the four priority queues on the Switch. In order to implement QoS, the user is required to instruct the Switch to examine the header of a packet to see if it has the proper identifying tag tagged. Then the user may forward these tagged packets to designated queues on the Switch where they will be emptied, based on priority.

"The DUT support strict mode for 802.1p QoS. The untagged pkt will follow the priority 0 to work (i.e. class 1)."

## Understanding QoS

The Switch has four priority queues. These priority queues are labeled as 3, the high queue to 0, the lowest queue. The eight priority tags, specified in IEEE 802.1p are mapped to the Switch's priority tags as follows:

- Priority 0 is assigned to the Switch's Q1 queue.
- Priority 1 is assigned to the Switch's Q0 queue.
- Priority 2 is assigned to the Switch's Q0 queue.
- Priority 3 is assigned to the Switch's Q1 queue.
- Priority 4 is assigned to the Switch's Q2 queue.
- Priority 5 is assigned to the Switch's Q2 queue.
- Priority 6 is assigned to the Switch's Q3 queue.
- Priority 7 is assigned to the Switch's Q3 queue.

The Switch uses strict priority for Scheduling. Strict priority-based scheduling, any packets residing in the higher priority queues are transmitted first.

## D-Link's Green Technology

D-Link's Green Technology implements special power-saving features under speed at 1000Mbps that detect cable length and link status and adjust power usage accordingly.

Green Ethernet Technology saves energy in two specific ways:

Method 1: If there is no link on a port, such as when there is no computer connected to the port or the connected computer is powered off, Green Ethernet Technology will enter a "sleep mode", drastically reducing power used for that port.

Method 2: D-Link Green Ethernet detects the length of connected Ethernet cable and adjusts power usage accordingly without affecting performance. This way, a port connected to a less than 10m cable only uses as much power as it needs, instead of using full power, which is only needed for 100m cables.

## Switching Technology

Another key development pushing the limits of Ethernet technology is in the field of switching technology. A switch bridges Ethernet packets at the MAC address level of the Ethernet protocol transmitting among connected Ethernet or fast Ethernet LAN segments.

Switching is a cost-effective way of increasing the total network capacity available to users on a local area network. A switch increases capacity and decreases network loading by making it possible for a local area network to be divided into different *segments* that do not compete with each other for network transmission capacity, decreasing the load on each segment.

The switch acts as a high-speed selective bridge between the individual segments. Traffic that needs to go from one segment to another (from one port to another) is automatically forwarded by the switch, without interfering with any other segments (ports). This allows the total network capacity to be multiplied, while still maintaining the same network cabling and adapter cards.

For Fast Ethernet or Gigabit Ethernet networks, a Switch is an effective way of eliminating problems of chaining hubs beyond the “two-repeater limit.” A Switch can be used to split parts of the network into different collision domains, for example, making it possible to expand your Fast Ethernet network beyond the 205-meter network diameter limit for 100BASE-TX networks. Switches supporting both traditional 10Mbps Ethernet and 100Mbps Fast Ethernet are also ideal for bridging between existing 10Mbps networks and new 100Mbps networks.

Switching LAN technology is a marked improvement over the previous generation of network bridges, which were characterized by higher latencies. Routers have also been used to segment local area networks, but the cost of a router and the setup and maintenance required make routers relatively impractical. Today’s Switches are an ideal solution to most kinds of local area network congestion problems.

## Switch Description

The DGS-1008D Switch is equipped with eight ports providing dedicated 10, 100, or 1000 Mbps bandwidth. These ports can be used for connecting PCs, printers, servers, routers, Switches, hubs, and other network devices. The eight multi-speed ports use standard twisted pair cabling and are ideal for segmenting networks into small, connected subnets. Each port can support up to 2000 Mbps of throughput in full-duplex mode. This stand-alone Switch enables the network to use some of the most demanding multimedia and imaging applications concurrently with other user applications without creating bottlenecks.

## Features

The DGS-1008D 8-Port 10/100/1000BASE-T Gigabit Ethernet Switch was designed for easy installation and high performance in an environment where traffic on the network and the number of users increase continuously.

- Eight 10/100/1000BASE-T Gigabit Ethernet ports
- Cable Diagnostics function at Switch boot up
- Supports Auto-Negotiation for 10/100/1000Mbps and duplex mode
- Supports Auto-MDI/MDIX for each port
- Supports Full/Half duplex transfer mode for 10 and 100Mbps
- Supports Full-duplex transfer mode for 1000Mbps
- Full wire speed reception and transmission
- Store-and-Forward switching method
- Supports 4K absolute MAC addresses
- Supports 192KBytes RAM for data buffering
- IEEE 802.3x flow control for full duplex
- IEEE 802.1p priority queues
- Back pressure flow control for half duplex
- Jumbo Frame Support at 1000Mbps (9720Bytes )
- D-Link’s Green Technology

## Front-Panel Components

The top case of the Switch consists of LED indicators, 8 (10/100/1000 Mbps) Ethernet ports.

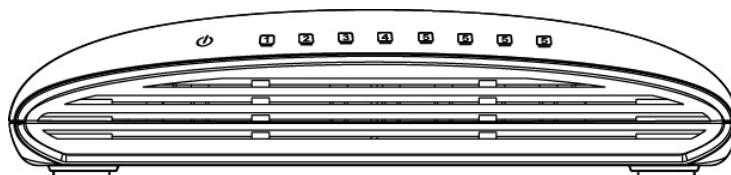
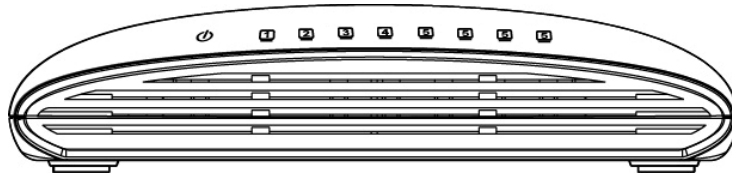

Figure 1-1. Front Panel View of the Switch

Comprehensive LED indicators display the status of the Switch and the network.

## LED Indicators

The LED indicators of the Switch include Power, and Link/Act/Speed. The following shows the LED indicators for the Switch along with an explanation of each indicator.



**Figure 1-2. LED Indicators**

Comprehensive LED indicators display the conditions of the Switch and status of the network. A description of these LED indicators follows (see LED Indicators). The LED indicators of the Switch include Power, Link/Act/Speed. The Cable Diagnostics functions of the Switch are indicated by Link/Act/Speed LED, as described below.

- **Power Indicator**

This green indicator light is on when the Switch is receiving power; otherwise, it is off.

- **Link/Act/Speed**

When connected to a 1000Mbps device, this LED indicator light is green when the port is connected to a device and will blink as data is transmitted or received.

When connected to a 10/100Mbps device, this LED indicator light is amber when the port is connected to a device and will blink as data is transmitted or received.

- **Cable Diagnostics – LED Indications**

When the Switch is booted up (when the Switch is first powered on), the Cable Diagnostics function is initialized and run. The Cable Diagnostics function will detect three common faults in an Ethernet cable connecting the Switch to a remote network device: an open circuit (a lack of continuity between the pins at each end of the Ethernet cable or a disconnected cable), a short circuit (two or more conductors short-circuited), and improper termination (a termination resistance greater than the specified 100 ohms). Any of these common cable faults will be detected by the Cable Diagnostics function and the LEDs will display the results of the Cable Diagnostics function.

The Cable Diagnostics first scans the 5 / 8 Ethernet ports to determine if the Ethernet cable is in good working order. This process is indicated by the Link/Act/Speed LED blinking green for each of the 5 / 8 ports sequentially. If a cable fault is detected, it is indicated by the corresponding port's Link/Act/Speed LED glowing amber after the initial port scan. If the cable connection is good, the corresponding port's Link/Act/Speed LED will glowing green. After the display of cable status, the Switch is then reset for normal operation.

Note: There is no display of cable faults detected by the Cable Diagnostics during the normal operation of the Switch, only when the Switch is booted up or power-cycled.

## Rear Panel Description

### DC Power Jack:

Power is supplied through an external AC power adapter. Check the technical specification section for information about the AC power input voltage.

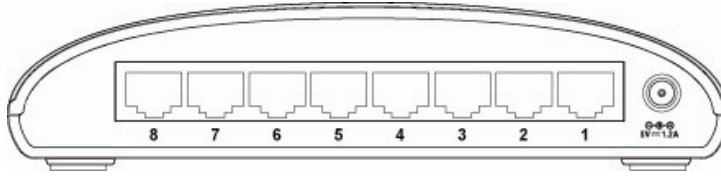

**Figure 1-3. Rear panel view of the Switch**

### 10/100/1000BASE-T Ports:

Eight (8) Gigabit Ethernet, Auto-Negotiating ports (10/100/1000Mbps)

Comprehensive LED indicators display the conditions of the Switch and status of the network.

## SECTION 2

# Installation

### *Package Contents*

### *Before You Connect to the Network*

### *Installing the Switch*

### *Power On*

## Package Contents

Open the shipping carton of the Switch and carefully unpack its contents. The carton should contain the following items:

- One DGS-1008D 8-Port 10/100/1000BASE-T Gigabit Ethernet Switch
- One external power adapter
- Wall-mounting kit
- CD with documentation

If any item is missing or damaged, please contact your local D-Link reseller for replacement.

## Before You Connect to the Network

The site where you install the Switch may greatly affect its performance. Please follow these guidelines for setting up the Switch.

- Install the Switch on a sturdy, level surface that can support at least 3 kg (6.6 lbs.) of weight. Do not place heavy objects on the Switch.
- The power outlet should be within 1.82 meters (6 feet) of the Switch.
- Visually inspect the power cord and see that it is fully secured to the AC power port.
- Make sure that there is adequate space for proper heat dissipation from and adequate ventilation around the Switch. Leave at least 10 cm (4 inches) of space at the front and rear of the Switch for ventilation.
- Install the Switch in a fairly cool and dry place for the acceptable temperature and humidity operating ranges.
- Install the Switch in a site free from strong electromagnetic field generators (such as motors), vibration, dust, and direct exposure to sunlight.
- When installing the Switch on a level surface, attach the rubber feet to the bottom of the device. The rubber feet cushion the Switch, protect the casing from scratches, and prevent it from scratching other surfaces.

## Mounting the Switch on a Wall

The DGS-1008D can also be mounted on a wall. Two mounting slots are provided on the bottom of the switch for this purpose. Please make sure that the front panel is exposed in order to view the LEDs. Please refer to the illustration below:

### A.) Mounting on a cement wall

1. Mount the Nylon screw anchors into a cement wall.
2. Drive the T3 x 15L screws into the Nylon screw anchors.
3. Hook the mounting holes of the switch back on the screws; you have completed the wall-mount.

### B.) Mounting on a wood wall

1. Drive the T3 x 15 L screws into the wood wall.
2. Hook the mounting holes of the switch back on the screws; you have completed the wall-mount.

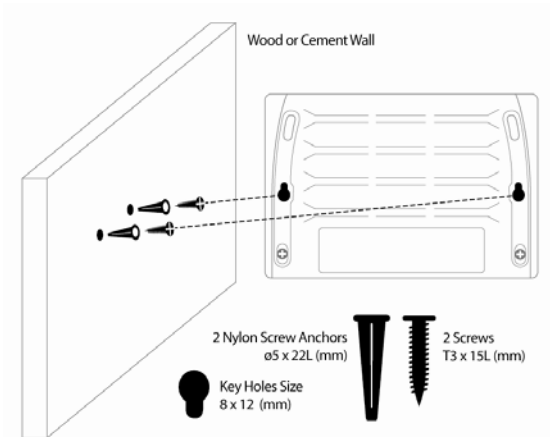

- (1) 3/4 inch minimum for wood wall.
- (2) 3 inch minimum for cement wall.

Figure 2-1. Mounting the Switch to a Wall

### C.) Mounting on a metal wall

1. Mount the magnetic base screws (optional) onto the mounting holes of the switch.
2. Attach the switch to a metallic surface.
3. The magnet kit is optional and is not included in the package contents.

## Power On

Plug one end of the AC to DC power adapter into the power connector of the Switch and the other end into the local power source outlet.

After the Switch is powered on, the LED indicators will momentarily blink. This blinking of the LED indicators represents a reset of the system.

## Power Failure

As a precaution, in the event of a power failure, unplug the Switch. When power is resumed, plug the Switch back in.

## Section 3

# Connecting The Switch

- Switch To End Node*
- Switch To Hub or Switch*
- Connecting To a Server*



**NOTE:** All 8 high-performance NWay Ethernet ports can support both MDI-II and MDI-X connections.

## Switch To End Node

End nodes include PCs outfitted with a 10, 100, or 1000 Mbps RJ-45 Ethernet/Fast Ethernet Network Interface Card (NIC) and most routers.

An end node can be connected to the Switch via a twisted-pair Category 3, 4, 5, or 5e UTP/STP cable. The end node can be connected to any of the ports of the Switch.

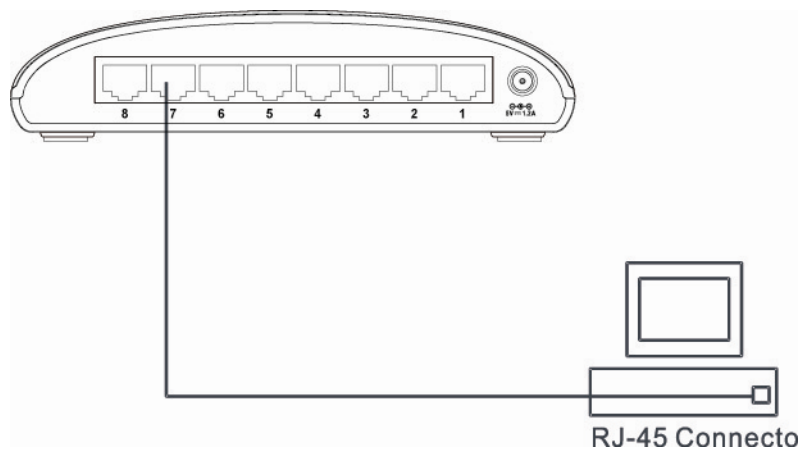

Figure 3-1. Switch connected to an end node

## Switch to Hub or Switch

These connections can be accomplished in a number of ways using a standard Ethernet cable.

- A 10BASE-T hub or switch can be connected to the Switch via a twisted-pair Category 3, 4, 5, or 5e UTP/STP cable.
- A 100BASE-T hub or switch can be connected to the Switch via a twisted -pair Category 5 or better UTP/STP cable.
- A 1000BASE-T switch can be connected to the Switch via a twisted -pair Category 5 or better UTP/STP cable.

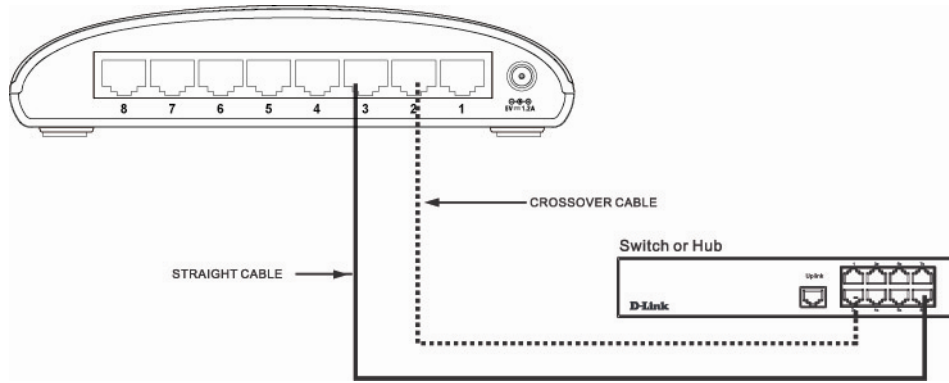

Figure 3-2. Switch connected to a port on a hub or switch using either a straight or crossover cable—any standard Ethernet cable is fine

## Connecting To Network Backbone or Server

Any of the eight Gigabit Ethernet ports are ideal for uplinking to a network backbone or network server.

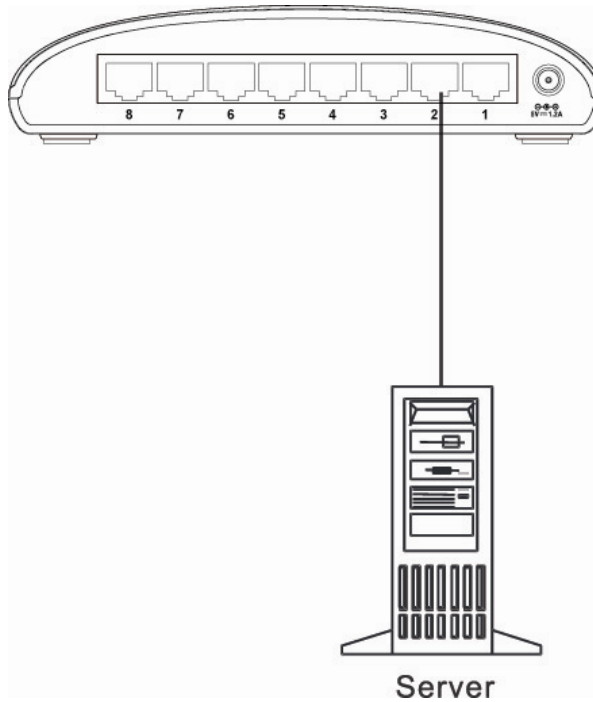

Figure 3-3. Connection to a Server



# Appendix A

## Technical Specifications

General																
<b>Standards:</b>	IEEE 802.3ab 1000BASE-T IEEE 802.3u 100BASE-TX IEEE 802.3 10BASE-T IEEE 802.3x Flow Control IEEE 802.1p priority Queues															
<b>Protocol:</b>	CSMA/CD															
<b>Data Transfer Rate:</b>	<table style="width: 100%; border-collapse: collapse;"> <tr> <td style="width: 30%;">Ethernet:</td> <td style="width: 30%;">10Mbps</td> <td style="width: 40%;">(Half-duplex)</td> </tr> <tr> <td></td> <td>20Mbps</td> <td>(Full-duplex)</td> </tr> <tr> <td>Fast Ethernet:</td> <td>100Mbps</td> <td>(Half-duplex)</td> </tr> <tr> <td></td> <td>200Mbps</td> <td>(Full-duplex)</td> </tr> <tr> <td>Gigabit Ethernet:</td> <td>2000Mbps</td> <td>(Full-duplex)</td> </tr> </table>	Ethernet:	10Mbps	(Half-duplex)		20Mbps	(Full-duplex)	Fast Ethernet:	100Mbps	(Half-duplex)		200Mbps	(Full-duplex)	Gigabit Ethernet:	2000Mbps	(Full-duplex)
Ethernet:	10Mbps	(Half-duplex)														
	20Mbps	(Full-duplex)														
Fast Ethernet:	100Mbps	(Half-duplex)														
	200Mbps	(Full-duplex)														
Gigabit Ethernet:	2000Mbps	(Full-duplex)														
<b>Topology:</b>	Star															
<b>Network Cables:</b>	Ethernet: 2-pair UTP Cat. 3,4,5, Unshield Twisted Pair (UTP) Cable Fast Ethernet: 2-pair UTP Cat. 5, Unshield Twisted Pair (UTP) Cable Gigabit Ethernet: 4-pair UTP Cat. 5, Unshield Twisted Pair (UTP) Cable															
<b>Number of Ports:</b>	Eight 10/100/1000BASE-T Gigabit Ethernet ports															

Physical and Environmental	
<b>DC Inputs:</b>	AC-DC 5V/1.2A This unit is to be used with a power supply listed below, or equivalent: CF0605-B / AMS1-0501200FU for USA    CF0605-D / AMS1-0501200FS for Australia CF0605-C / AMS1-0501200FB for UK    CF0605-N / AMS1-0501200FC for China CF0605-E / AMS1-0501200FV for Europe (Different power lists would be packed for different shipping regions)
<b>Operating Temperature:</b>	0 °C ~ 40°C (32°F ~ 104F °)
<b>Storage Temperature:</b>	-10°C ~ 70°C (14°F ~ 158°F)
<b>Humidity:</b>	5% ~ 95% RH, non-condensing
<b>Dimensions:</b>	6.5 in x 4.5 in x 1.4 in (164.5 mm x 112.4 mm x 35.0 mm)
<b>EMI</b>	FCC Class B, ICES-003 Class B, CE Class B, VCCI Class B
<b>Safety:</b>	cUL + LVD

<b>Performance</b>	
<b>Transmission Method:</b>	Store-and-forward
<b>RAM Buffer:</b>	192KBytes per device
<b>Filtering Address Table:</b>	4K MAC address per device
<b>Packet Filtering/ Forwarding Rate:</b>	Full wire speed
<b>MAC Address Learning:</b>	Self-learning, auto-aging

## Glossary

**1000BASE-SX** – A short laser wavelength on multimode fiber optic cable for a maximum length of 550 meters.

**1000BASE-LX** – A long wavelength for a "long haul" fiber optic cable for a maximum length of 10 kilometers.

**100BASE-FX** – 100Mbps Ethernet implementation over fiber.

**100BASE-TX** – 100Mbps Ethernet implementation over Category 5 and Type 1 Twisted Pair cabling.

**10BASE-T** – The IEEE 802.3 specification for Ethernet over Unshielded Twisted Pair (UTP) cabling.

**aging** – The automatic removal of dynamic entries from the Switch Database which have timed-out and are no longer valid.

**ATM** – Asynchronous Transfer Mode. A connection oriented transmission protocol based on fixed length cells (packets). ATM is designed to carry a complete range of user traffic, including voice, data, and video signals.

**auto-negotiation** – A feature on a port, which allows it to advertise its capabilities for speed, duplex, and flow control. When connected to an end station that also supports auto-negotiation, the link can self-detect its optimum operating setup.

**backbone port** – A port that does not learn device addresses, and that receives all frames with an unknown address. Backbone ports are normally used to connect the Switch to the backbone of your network. Note that backbone ports were formerly known as designated downlink ports.

**backbone** – The part of a network used as the primary path for transporting traffic between network segments.

**Bandwidth** – Information capacity, measured in bits per second, that a channel can transmit. The bandwidth of Ethernet is 10Mbps, the bandwidth of Fast Ethernet is 100Mbps.

**baud rate** – The switching speed of a line. Also known as *line speed*.

**BOOTP** – The BOOTP protocol allows you to automatically map an IP address to a given MAC address each time a device is started. In addition, the protocol can assign the subnet mask and default gateway to a device.

**bridge** – A device that interconnects local or remote networks no matter what higher level protocols are involved. Bridges form a single logical network, centralizing network administration.

**broadcast** – A message sent to all destination devices on the network.

**broadcast storm** – Multiple simultaneous broadcasts that typically absorb available network bandwidth and can cause network failure.

**console port** – The port on the Switch accepting a terminal or modem connector. It changes the parallel arrangement of data within computers to the serial form used on data transmission links. This port is most often used for dedicated local management.

**CSMA/CD** – Channel access method used by Ethernet and IEEE 802.3 standards, in which devices transmit only after finding the data channel clear for some period of time. When two devices transmit simultaneously, a collision occurs and the colliding devices delay their retransmissions for a random amount of time.

**data center switching** – The point of aggregation within a corporate network where a switch provides high-performance access to server farms, a high-speed backbone connection, and a control point for network management and security.

**Ethernet** – A LAN specification developed jointly by Xerox, Intel, and Digital Equipment Corporation. Ethernet networks operate at 10Mbps using CSMA/CD to run over cabling.

**Fast Ethernet** – 100Mbps technology based on the Ethernet/CD network access method.

**Flow Control** – (IEEE 802.3x) A means of holding packets back at the transmit port of the connected end station. Prevents packet loss at a congested switch port.

**forwarding** – The process of sending a packet toward its destination by an internetworking device.

**full duplex** – A system that allows packets to be transmitted and received at the same time and, in effect, doubles the potential throughput of a link.

**half duplex** – A system that allows packets to be transmitted and received, but not at the same time. Contrast with *full duplex*.

**IP address** – Internet Protocol address. A unique identifier for a device attached to a network using TCP/IP. The address is written as four octets separated with full-stops (periods), and is made up of a network section, an optional subnet section and a host section.

**IPX** – Internetwork Packet Exchange. A protocol allowing communication in a NetWare network.

**LAN** – Local Area Network. A network of connected computing resources (such as PCs, printers, servers) covering a relatively small geographic area (usually not larger than a floor or building). Characterized by high data rates and low error rates.

**latency** – The delay between the time a device receives a packet and the time the packet is forwarded out of the destination port.

**line speed** – See *baud rate*.

**main port** – The port in a resilient link that carries data traffic in normal operating conditions.

**MDI** – Medium Dependent Interface. An Ethernet port connection where the transmitter of one device is connected to the receiver of another device.

**MDIX** – Medium Dependent Interface Cross-over. An Ethernet port connection where the internal transmit and receive lines are crossed.

**MIB** – Management Information Base. Stores a device's management characteristics and parameters. MIBs are used by the Simple Network Management Protocol (SNMP) to contain attributes of their managed systems. The Switch contains its own internal MIB.

**multicast** – Single packets copied to a specific subset of network addresses. These addresses are specified in the destination-address field of the packet.

**protocol** – A set of rules for communication between devices on a network. The rules dictate format, timing, sequencing, and error control.

**resilient link** – A pair of ports that can be configured so that one will take over data transmission should the other fail. See also *main port* and *standby port*.

**RJ-45** – Standard 8-wire connectors for IEEE 802.3 10BASE-T networks.

**RMON** – Remote Monitoring. Subset of SNMP MIB II, which allows monitoring and management capabilities by addressing up to ten different groups of information.

**RPS** – Redundant Power System. A device that provides a backup source of power when connected to the Switch.

**server farm** – A cluster of servers in a centralized location serving a large user population.

**SLIP** – Serial Line Internet Protocol. A protocol that allows IP to run over a serial line connection.

**SNMP** – Simple Network Management Protocol. A protocol originally designed to be used in managing TCP/IP internets. SNMP is presently implemented on a wide range of computers and networking equipment and may be used to manage many aspects of network and end station operation.

**Spanning Tree Protocol** – (STP) A bridge-based system for providing fault tolerance on networks. STP works by allowing you to implement parallel paths for network traffic, and to ensure that redundant paths are disabled when the main paths are operational and enabled if the main paths fail.

**stack** – A group of network devices that are integrated to form a single logical device.

**standby port** – The port in a resilient link that will take over data transmission if the main port in the link fails.

**switch** – A device that filters, forwards, and floods packets based on the packet's destination address. The Switch learns the addresses associated with each switch port and builds tables based on this information to be used for the switching decision.

**TCP/IP** – A layered set of communications protocols providing Telnet terminal emulation, FTP file transfer, and other services for communication among a wide range of computer equipment.

**Telnet** – A TCP/IP application protocol that provides virtual terminal service, letting a user log in to another computer system and access a host as if the user were connected directly to the host.

**TFTP** – Trivial File Transfer Protocol. Allows you to transfer files (such as software upgrades) from a remote device using your switch's local management capabilities.

**UDP** – User Datagram Protocol. An Internet standard protocol that allows an application program on one device to send a datagram to an application program on another device.

**VLAN** – Virtual LAN. A group of location- and topology-independent devices that communicate as if they are on a common physical LAN.

**VLT** – Virtual LAN Trunk. A Switch-to-Switch link which carries traffic for all the VLANs on each Switch.

**VT100** – A type of terminal which uses ASCII characters. VT100 screens have a text-based appearance.