



DES-6300
Modular L3 Ethernet Switch
User's Guide

First Edition (September 2002)

6DES6300..01
Printed In Taiwan



RECYCLABLE

Wichtige Sicherheitshinweise

1. Bitte lesen Sie sich diese Hinweise sorgfältig durch.
2. Heben Sie diese Anleitung für den spätern Gebrauch auf.
3. Vor jedem Reinigen ist das Gerät vom Stromnetz zu trennen. Verwenden Sie keine Flüssig- oder Aerosolreiniger. Am besten dient ein angefeuchtetes Tuch zur Reinigung.
4. Um eine Beschädigung des Gerätes zu vermeiden sollten Sie nur Zubehörteile verwenden, die vom Hersteller zugelassen sind.
5. Das Gerät ist vor Feuchtigkeit zu schützen.
6. Bei der Aufstellung des Gerätes ist auf sichern Stand zu achten. Ein Kippen oder Fallen könnte Verletzungen hervorrufen. Verwenden Sie nur sichere Standorte und beachten Sie die Aufstellhinweise des Herstellers.
7. Die Belüftungsöffnungen dienen zur Luftzirkulation die das Gerät vor Überhitzung schützt. Sorgen Sie dafür, daß diese Öffnungen nicht abgedeckt werden.
8. Beachten Sie beim Anschluß an das Stromnetz die Anschlußwerte.
9. Die Netzanschlußsteckdose muß aus Gründen der elektrischen Sicherheit einen Schutzleiterkontakt haben.
10. Verlegen Sie die Netzanschlußleitung so, daß niemand darüber fallen kann. Es sollte auch nichts auf der Leitung abgestellt werden.
11. Alle Hinweise und Warnungen die sich am Geräten befinden sind zu beachten.
12. Wird das Gerät über einen längeren Zeitraum nicht benutzt, sollten Sie es vom Stromnetz trennen. Somit wird im Falle einer Überspannung eine Beschädigung vermieden.
13. Durch die Lüftungsöffnungen dürfen niemals Gegenstände oder Flüssigkeiten in das Gerät gelangen. Dies könnte einen Brand bzw. Elektrischen Schlag auslösen.
14. Öffnen Sie niemals das Gerät. Das Gerät darf aus Gründen der elektrischen Sicherheit nur von autorisiertem Servicepersonal geöffnet werden.
15. Wenn folgende Situationen auftreten ist das Gerät vom Stromnetz zu trennen und von einer qualifizierten Servicestelle zu überprüfen:
 - a – Netzkabel oder Netzstecker sind beschädigt.
 - b – Flüssigkeit ist in das Gerät eingedrungen.
 - c – Das Gerät war Feuchtigkeit ausgesetzt.
 - d – Wenn das Gerät nicht der Bedienungsanleitung entsprechend funktioniert oder Sie mit Hilfe dieser Anleitung keine Verbesserung erzielen.
 - e – Das Gerät ist gefallen und/oder das Gehäuse ist beschädigt.
 - f – Wenn das Gerät deutliche Anzeichen eines Defektes aufweist.
16. Bei Reparaturen dürfen nur Originalersatzteile bzw. den Originalteilen entsprechende Teile verwendet werden. Der Einsatz von ungeeigneten Ersatzteilen kann eine weitere Beschädigung hervorrufen.
17. Wenden Sie sich mit allen Fragen die Service und Reparatur betreffen an Ihren Servicepartner. Somit stellen Sie die Betriebssicherheit des Gerätes sicher.
18. Zum Netzanschluß dieses Gerätes ist eine geprüfte Leitung zu verwenden, Für einen Nennstrom bis 6A und einem Gerätegewicht größer 3kg ist eine Leitung nicht leichter als H05VV-F, 3G, 0.75mm² einzusetzen.

Trademarks

Copyright ©2002.

Contents subject to change without prior notice.

All trademarks belong to their respective proprietors.

Copyright Statement

No part of this publication may be reproduced in any form or by any means or used to make any derivative such as translation, transformation, or adaptation without permission from the manufacturer, as stipulated by the United States Copyright Act of 1976.

FCC Warning

This equipment has been tested and found to comply with the limits for a Class A digital device, pursuant to Part 15 of the FCC Rules. These limits are designed to provide reasonable protection against harmful interference when the equipment is operated in a commercial environment. This equipment generates, uses, and can radiate radio frequency energy and, if not installed and used in accordance with this user's guide, may cause harmful interference to radio communications. Operation of this equipment in a residential area is likely to cause harmful interference in which case the user will be required to correct the interference at his own expense.

This device complies with part 15 of the FCC Rules. Operation is subject to the following two conditions: (1) This device may not cause harmful interference, and (2) this device must accept any interference received, including interference that may cause undesired operation.

CE Mark Warning

This is a Class A product. In a domestic environment, this product may cause radio interference in which case the user may be required to take adequate measures.

Warnung!

Dies ist in Produkt der Klasse A. Im Wohnbereich kann dieses Produkt Funkstoerungen verursachen. In diesem Fall kann vom Benutzer verlangt werden, angemessene Massnahmen zu ergreifen.

Precaución!

Este es un producto de Clase A. En un entorno doméstico, puede causar interferencias de radio, en cuyo caso, puede requerirse al usuario para que adopte las medidas adecuadas.

Attention!

Ceci est un produit de classe A. Dans un environnement domestique, ce produit pourrait causer des interférences radio, auquel cas l'utilisateur devrait prendre les mesures adéquates.

Attenzione!

Il presente prodotto appartiene alla classe A. Se utilizzato in ambiente domestico il prodotto può causare interferenze radio, nel cui caso è possibile che l'utente debba assumere provvedimenti adeguati.

VCCI Warning

注意

この装置は、情報処理装置等電波障害自主規制協議会(VCCI)の基準に基づく第一種情報技術装置です。この装置を家庭環境で使用すると電波妨害を引き起こすことがあります。この場合には使用者が適切な対策を講ずるよう要求されることがあります。

BSMI Warning

警告使用者

這是甲類的資訊產品,在居住的環境中使用時,可能會造成射頻干擾,在這種情況下使用者會被要求採取某些適當的對策。

TABLE OF CONTENTS

About This Guide	v
Conventions.....	v
Overview of this User's Guide.....	v
Introduction	6
Fast Ethernet Technology	6
Gigabit Ethernet Technology.....	6
Switching Technology	7
Features	7
Chassis	7
Switch Modules.....	8
Unpacking and Setup.....	11
Unpacking.....	11
Setup.....	11
Desktop or Shelf Installation.....	11
Rack Installation	12
Installing Modules	12
Connecting a Terminal.....	14
Power on.....	14
Power Failure	14
Identifying External Components	15
Front Panel.....	15
Side Panels	15
Optional Plug-in Modules	16
DES-6303 10BASE-T/100BASE-TX Module	16
DES-6304 100BASE-FX (MT-RJ) Module.....	16
DES-6305 100BASE-FX (SC) Gigabit Module	17
DES-6306 1000BASE-SX (SC) Gigabit Module	17
DES-6307 1000BASE-LX (SC) Gigabit Module	18
DES-6308 1000BASE-T (RJ-45) Module.....	18
DES-6309 GBIC Module.....	19
Power Supply Modules	19
LED Indicators	19
Connecting The Switch.....	21
Switch to End Node	21
Switch to Hub or Switch	21
10BASE-T Device	21
100BASE-TX Device	22
1000BASE-T Device	22
100BASE-FX Device	22
1000BASE-SX Device	22
1000BASE-LX Device	22
Cable Lengths.....	22
Switch Management Concepts.....	24
IP Addresses and SNMP Community Names	24
Traps.....	24
MIBs.....	25
Packet Forwarding.....	25

Aging Time	26
Filtering Database	26
Spanning Tree Algorithm	26
STA Operation Levels	27
User-Changeable STA Parameters	27
Illustration of STA	28
Port Trunking	29
VLANs & Broadcast Domains.....	30
MAC-based Broadcast Domains	30
802.1Q VLANs.....	31
Port-based VLANs	34
Broadcast Storms	34
Segmenting Broadcast Domains	34
Eliminating Broadcast Storms.....	34
Using ConfigMaster	36
Installation	37
General System Requirements.....	37
Installing ConfigMaster	37
Troubleshooting	43
Starting ConfigMaster	45
Error Log.....	46
Using ConfigMaster Windows	48
Setting ConfigMaster Options.....	50
The Front Panel Display	57
ConfigMaster Shortcuts.....	61
Using Tables	62
Working With Configuration Files	64
Managing the Device.....	68
Device Global Parameters.....	69
Device Features.....	71
Configuring VLANs	71
Working With VLANs	72
Configuring Ports.....	80
Port Properties	80
Port Mirroring	86
Storm Control	87
Configuring GVRP and Trunking.....	89
GVRP	89
Trunk.....	94
Configuring Bridging.....	100
Operating Parameters	100
Unicast	101
Spanning Tree.....	104
Rapid Spanning Tree.....	113
Configuring Routing	120
IP	120
IPM	156
IPX.....	174
Configuring Security Options.....	194
Community Table.....	194
Configuring Quality of Service.....	196
Global Parameters.....	196
Profile Table	197
Working With Statistics	210
Element Statistics	210
Interface Statistics	215
Port Statistics.....	217

Working With Services	229
Device Tuning	229
Event Log	233
Refresh	234
Polling Configuration	234
Community Change	235
Ping	235
Refresh Device Software	237
Technical Specifications	239
Sample Configuration File	241
Index	243

ABOUT THIS GUIDE

This User's Guide tells you how to install your Modular Layer 3 Ethernet Switch, how to connect it to your Ethernet network, and how to set its configuration using either the built-in console interface or Web-based management.

Conventions

References in this manual to the DES-6300 are frequently written simply as "Switch" or "Switches" where the text applies to both models. Model numbers are normally used only to differentiate between specific Switches where necessary.

Unless differentiated by model number, all information applies to both models.

Overview of this User's Guide

- ◆ Chapter 1, "*Introduction.*" Describes the Switch and its features.
- ◆ Chapter 2, "*Unpacking and Setup.*" Helps you get started with the basic installation of the Switch.
- ◆ Chapter 3, "*Identifying External Components.*" Describes the front panel, side panels, optional plug-in modules, and LED indicators of the Switch.
- ◆ Chapter 4, "*Connecting the Switch.*" Tells how you can connect the Switch to your Ethernet network as well as providing an informational cable length table.
- ◆ Chapter 5, "*Switch Management Concepts.*" Talks about how to manage the Switch.
- ◆ Chapter 6, "*Using ConfigMaster.*" Tells how to use the built-in configuration software to change, set, and monitor Switch performance and security.
- ◆ Appendix A, "*Technical Specifications.*" Lists the technical specifications of the Switch.
- ◆ Appendix B, "*RJ-45 Pin Specifications.*" Shows the details and pin assignments for the RJ-45 receptacle/connector.
- ◆ Appendix C, "*Sample Configuration File.*"

INTRODUCTION

This section describes the features of the Switch, as well as giving some background information about Ethernet/Fast Ethernet, Gigabit Ethernet, and switching technology.

Fast Ethernet Technology

The growing importance of LANs and the increasing complexity of desktop computing applications are fueling the need for high performance networks. A number of high-speed LAN technologies are proposed to provide greater bandwidth and improve client/server response times. Among them, Fast Ethernet, or 100BASE-T, provides a non-disruptive, smooth evolution from the current 10BASE-T technology. The dominating market position virtually guarantees cost effective and high performance Fast Ethernet solutions in the years to come.

100Mbps Fast Ethernet is a standard specified by the IEEE 802.3 LAN committee. It is an extension of the 10Mbps Ethernet standard with the ability to transmit and receive data at 100Mbps, while maintaining the Carrier Sense Multiple Access with Collision Detection (CSMA/CD) Ethernet protocol.

Gigabit Ethernet Technology

Gigabit Ethernet is an extension of IEEE 802.3 Ethernet utilizing the same packet structure, format, and support for CSMA/CD protocol, full duplex, flow control, and management objects, but with a tenfold increase in theoretical throughput over 100Mbps Fast Ethernet and a one hundred-fold increase over 10Mbps Ethernet. Since it is compatible with all 10Mbps and 100Mbps Ethernet environments, Gigabit Ethernet provides a straightforward upgrade without wasting a company's existing investment in hardware, software, and trained personnel.

The increased speed and extra bandwidth offered by Gigabit Ethernet is essential to coping with the network bottlenecks that frequently develop as computers and their busses get faster and more users use applications that generate more traffic. Upgrading key components, such as your backbone and servers to Gigabit Ethernet can greatly improve network response times as well as significantly speed up the traffic between your subnets.

Gigabit Ethernet enables fast optical fiber connections to support video conferencing, complex imaging, and similar data-intensive applications. Likewise, since data transfers occur 10 times faster than Fast Ethernet, servers outfitted with Gigabit Ethernet NIC's are able to perform 10 times the number of operations in the same amount of time.

In addition, the phenomenal bandwidth delivered by Gigabit Ethernet is the most cost-effective method to take advantage of today and tomorrow's rapidly improving switching and routing internetworking technologies. And with expected advances in the coming years in silicon technology and digital signal processing that will enable Gigabit Ethernet to eventually operate over unshielded twisted-pair (UTP) cabling, outfitting your network with a powerful 1000Mbps-capable backbone/server connection creates a flexible foundation for the next generation of network technology products.

Switching Technology

Another key development pushing the limits of Ethernet technology is in the field of switching technology. A switch bridges Ethernet packets at the MAC address level of the Ethernet protocol transmitting among connected Ethernet, Fast Ethernet, or Gigabit Ethernet LAN segments.

Switching is a cost-effective way of increasing the total network capacity available to users on a local area network. A switch increases capacity and decreases network loading by making it possible for a local area network to be divided into different *segments* which don't compete with each other for network transmission capacity, giving a decreased load on each.

The switch acts as a high-speed selective bridge between the individual segments. Traffic that needs to go from one segment to another (from one port to another) is automatically forwarded by the switch, without interfering with any other segments (ports). This allows the total network capacity to be multiplied, while still maintaining the same network cabling and adapter cards.

For Fast Ethernet or Gigabit Ethernet networks, a switch is an effective way of eliminating problems of chaining hubs beyond the "two-repeater limit." A switch can be used to split parts of the network into different collision domains, for example, making it possible to expand your Fast Ethernet network beyond the 205 meter network diameter limit for 100BASE-TX networks. Switches supporting both traditional 10Mbps Ethernet and 100Mbps Fast Ethernet are also ideal for bridging between existing 10Mbps networks and new 100Mbps networks.

Switching LAN technology is a marked improvement over the previous generation of network bridges, which were characterized by higher latencies. Routers have also been used to segment local area networks, but the cost of a router and the setup and maintenance required make routers relatively impractical. Today's switches are an ideal solution to most kinds of local area network congestion problems.

Features

The DES-6300 is a high performance modular switch platform that allows a customized array of Layer 2 and Layer 3 functions to be easily installed and managed in a single device. The Switch is ideal for expanding enterprise networks and environments where traffic volume and needs fluctuate.

Switch features include:

Chassis

The chassis is the main unit that modules and power supplies are installed into. A CPU module and a power supply module come preinstalled in the chassis.

Chassis features include:

- ◆ Six slots for installing networking modules (plus one slot reserved for the CPU)
- ◆ Two slots for installing redundant power supply modules
- ◆ 31.99 Gigabit/sec. (Gbps) backplane switching fabric
- ◆ Hot-swappable design for power supply modules
- ◆ Networking modules warm-swappable (except CPU module)
- ◆ Ears and screws for rack mounting

Switch Modules

The plug-in modules available for the switch are optional except for the CPU module. These modules are described below:

CPU Module

A single CPU module must be present and must be installed in first (uppermost) slot.

Layer 2 support includes:

- ◆ Layer 2 switching based on MAC address & VLAN ID
- ◆ Store and Forward packet switching
- ◆ Broadcast Storm rate filtering
- ◆ Supports static filtering (based on MAC address)
- ◆ Supports IEEE 802.1Q VLAN (Static VLAN)
- ◆ Proprietary simplified Port-based VLANs
- ◆ IEEE 802.1d Spanning Tree support
- ◆ Address table: 64K MAC address per switch
- ◆ 96 Static VLAN Entries (in IEEE 802.1Q VLANs mode)
- ◆ Supports 802.1p priority queuing (2 priority queues)
- ◆ Port Aggregation (Port-Trunking) Capability
- ◆ Port Mirroring
- ◆ IGMP snooping
- ◆ Head Of Line (HOL) Blocking Prevention
- ◆ RS-232 port for out-of-band management and system configuration
- ◆ Telnet Remote Configuration
- ◆ TFTP software upgrades, settings file and switch log uploads
- ◆ NMS (Net Management System)
- ◆ CLI (Command Line Interface)
- ◆ SNMP Agents:
 - MIB-II (RFC 1213)
 - RMON MIB (RFC 1757)
 - Bridge MIB (RFC 1493)
 - Supports four RMON (1, 2, 3, 9) groups
- ◆ Port Security
- ◆ BootP support

Layer 3 support includes:

- ◆ Support for DHCP Client
- ◆ Support RIP1 and RIP2 routing protocol
- ◆ Support OSPF routing protocol

- ◆ Support IGMP, IP Multicast packet filtering, support QoS (Quality of Service)
- ◆ Support Multicast Routing protocol: DVMRP, PIM DM
- ◆ Support Layer 3 Access Control List, (ACL)

Optional Modules:

DES-6303 10BASE-T/100BASE-TX Module

- ◆ Sixteen 10BASE-T/100BASE-TX ports
- ◆ Fully compliant with IEEE 802.3 10BASE-T, IEEE 802.3u 100BASE-TX
- ◆ All 10/100Mbps ports support NWay auto-negotiation
- ◆ Back pressure Flow Control support for half-duplex mode
- ◆ IEEE 802.3x-compliant Flow Control support for full duplex

DES-6304 100BASE-FX (MT-RJ) Module

- ◆ Twelve 100BASE-FX (MT-RJ) Fast Ethernet ports
- ◆ Fully compliant with IEEE 802.3u 100BASE-FX
- ◆ IEEE 802.3x compliant Flow Control support for full duplex

DES-6305 100BASE-FX (SC) Module

- ◆ Eight 100BASE-FX (SC) Fast Ethernet ports
- ◆ Connects to a 100BASE-FX device at full duplex.
- ◆ Fully compliant with IEEE 802.3u 100BASE-FX
- ◆ Supports Full-duplex operation only
- ◆ IEEE 802.3x-compliant Flow Control support

DES-6306 1000BASE-SX (SC) Module

- ◆ Two 1000BASE-SX (SC) Gigabit Ethernet ports
- ◆ Fully compliant with IEEE 802.3z
- ◆ Support full-duplex operation only
- ◆ IEEE 802.3x-compliant Flow Control support

DES-6307 1000BASE-LX (SC) Module

- ◆ Two 1000BASE-LX (SC) Gigabit Ethernet ports
- ◆ Fully compliant with IEEE 802.3z
- ◆ Support full-duplex operation only
- ◆ IEEE 802.3x-compliant Flow Control support

DES-6308 1000BASE-T (RJ-45) Module

- ◆ Two 1000BASE-T Gigabit Ethernet ports
- ◆ Connects to 1000BASE-T devices only at full duplex and auto-negotiating 10/100/1000 Mbps ports
- ◆ Fully compliant with IEEE 802.3ab

- ◆ Fully compliant with IEEE 802.1Q/P
- ◆ Back pressure Flow Control support for half-duplex mode
- ◆ IEEE 802.3x compliant Flow Control support for full duplex

DES-6309 GBIC Module

- ◆ Two GBIC Ethernet ports
- ◆ Fully compliant with IEEE 802.3z
- ◆ Support full-duplex operation only
- ◆ IEEE 802.3x-compliant Flow Control support

Power Supply Modules

- ◆ Dual power modules design
- ◆ Current sharing design
- ◆ Full redundant feature design to ensure continuous operation
- ◆ If one power module fails, the other will take over all current supply automatically
- ◆ Hot-swappable/Hot-pluggable
- ◆ Power management functions enabled
- ◆ Revolving handle design
- ◆ Input: 90 ~ 264 VAC, 47 ~ 63Hz
- ◆ Output: 3.3V 80A maximum, 12V 2A maximum

UNPACKING AND SETUP

This chapter provides unpacking and setup information for the Switch.

Unpacking

Open the shipping carton of the Switch and carefully unpack its contents. The carton should contain the following items:

- ◆ One switch chassis
- ◆ One management module (pre-installed in uppermost slot)
- ◆ One power supply module (pre-installed)
- ◆ One mounting kit: four mounting brackets and screws
- ◆ Four rubber feet with adhesive backing
- ◆ One AC power cord
- ◆ One console cable
- ◆ One printed copy of the Quickstart Guide
- ◆ One CD-ROM containing this User's Guide

If any item is found missing or damaged, please contact your local reseller for replacement.

Setup

The setup of the Switch can be performed using the following steps:

- ◆ The surface must support at least 5 kg.
- ◆ The power outlet should be within 1.82 meters (6 feet) of the device.
- ◆ Visually inspect the power cord and see that it is secured fully to the AC power connector.
- ◆ Make sure that there is proper heat dissipation from and adequate ventilation around the Switch. Do not place heavy objects on the Switch.

Desktop or Shelf Installation

When installing the Switch on a desktop or shelf, the rubber feet included with the device must be first attached. Attach these cushioning feet on the bottom at each corner of the device. Allow enough ventilation space between the device and the objects around it.

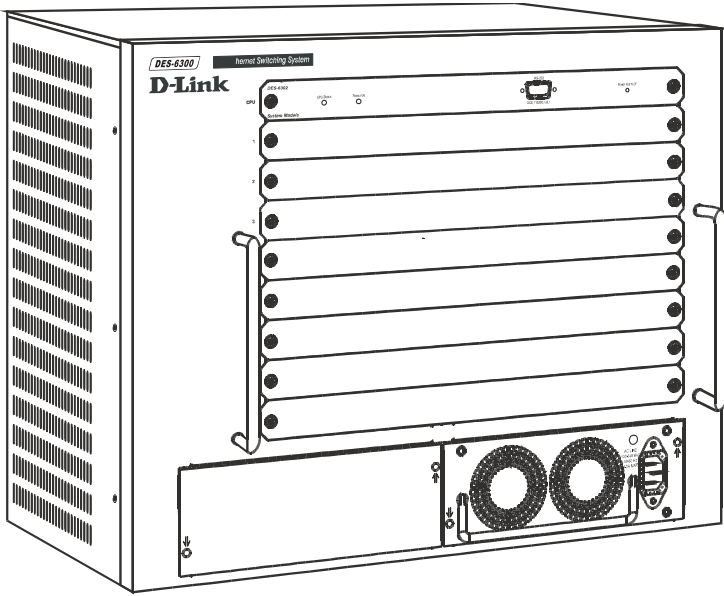

Figure 2- 1. Switch installed on a Desktop or Shelf

Rack Installation

The Switch can be mounted in an EIA standard size, 19-inch rack, which can be placed in a wiring closet with other equipment. To install, attach the mounting brackets on the Switch's front panel (one on each side) and secure them with the screws provided.

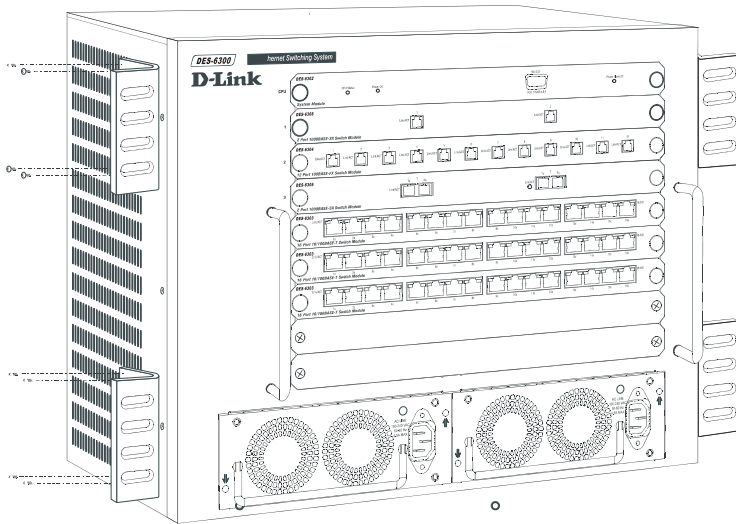

Figure 2- 2. Attaching the mounting brackets to the Switch

Then, use the screws provided with the equipment rack to mount the Switch in the rack.

Installing Modules

The DES-6300 supports up to 6 modules that can be installed into the module bays. Networking modules are warm-swappable, meaning they can be added and removed while power to the switch is

ON. After warm-swapping a networking module, the switch will automatically be rebooted. Make sure to use the Save Changes command to save the current configuration to NV-RAM before warm-swapping modules. The CPU module, however, is NOT hot-swappable. Removing or inserting the CPU module while the power is on may cause irreparable damage to the module and/or to the Switch itself. Further, make sure you have unplugged the power cord from the removable power supply module before inserting or removing it from the Switch.

CAUTION: Due to the high energy present in this system, extreme caution should be exercised whenever adding or removing system components. No element of this system may be installed or removed except by an authorized technician.

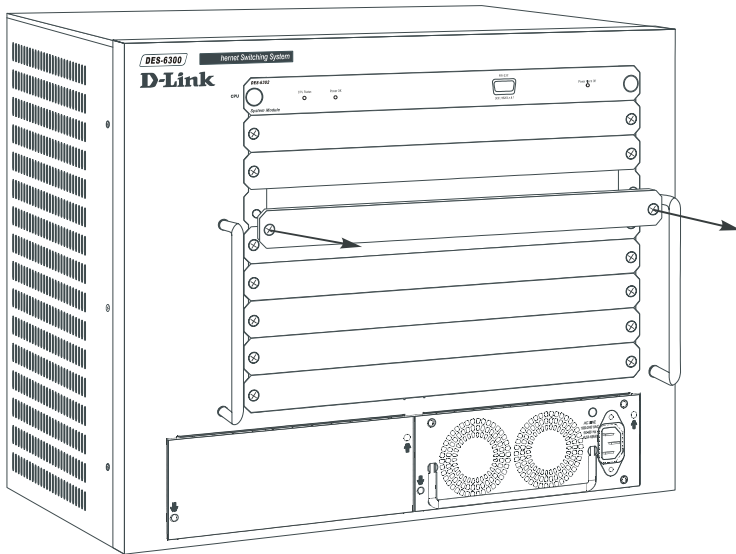

Figure 2-3. Removing a Blank Slot Cover

Modules can be installed into any free slot, except the CPU module. The CPU module must be installed in the uppermost (top) slot. To install a module, simply remove a blank slot cover and slide the module along the guide rails until it snaps firmly in place.

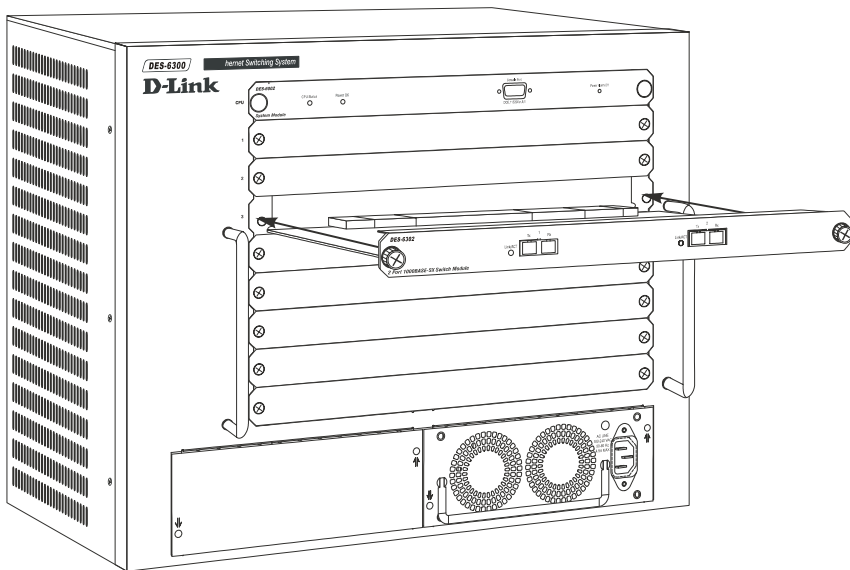

Figure 2-4. Installing a Module

Connecting a Terminal

The DES-6300 can perform basic switching functions without special configuration, but to use the Switch's advanced features you must first configure the unit through a terminal (a VT-100 serial data terminal or a computer running a VT-100 emulator). The connection is made through the Switch's Diagnostic RS-232 port, which is configured at the factory as follows:

◆ Baud Rate:	115200
◆ Data Bits:	8
◆ Parity:	none
◆ Stop Bits:	1
◆ Flow Control:	none

The RS-232 port has a nine-socket D-shell connector with IBM-type DCE wiring, and can be connected to the terminal using an off-the-shelf RS-232 cable with the proper connectors for the terminal and the DES-6300.

Power on

Power up the DES-6300 as follows:

- ◆ Make sure the power module is properly installed in the device.
- ◆ Plug the device end of the supplied power cord firmly into the power inlet on the DES-6300's front panel of the redundant power supply.
- ◆ Plug the outlet end of the power cord firmly into a suitable AC outlet.
- ◆ Observe the DES-6300's LED indicators to make sure the Switch is operating correctly.

The DES-6300's LED indicators operate as follows during a normal power-up:

- ◆ All indicators blink momentarily to indicate a system reset.
- ◆ The Power indicator flashes for about 20 seconds while the switch prepares its run-time software and performs a self-test.
- ◆ The Power indicator begins shining steadily, and the remaining indicators begin reflecting port and system status.

Power Failure

As a precaution, the Switch should be unplugged in case of an impending power failure. When power is resumed, plug the Switch back in.

IDENTIFYING EXTERNAL COMPONENTS

This chapter describes the front panel, side panels, optional plug-in modules, and LED indicators of the Switch.

Front Panel

The front panel of the Switch consists nine slide-in module slots for networking modules, two slide-in module slots for power supply modules, an RS-232 communication port, and LED indicators.

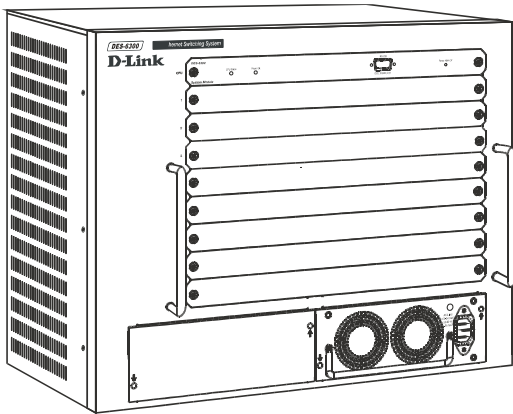

Figure 3- 1. Front panel view of the Switch

The front panel features:

- ◆ Comprehensive LED indicators display the conditions of the Switch and status of the network. A description of these LED indicators follows (see *LED Indicators*).
- ◆ An RS-232 DCE console port is used to diagnose the Switch via a connection to a terminal (or PC) and Local Console Management.
- ◆ Seven slide-in module slots installing networking modules and the CPU module.
- ◆ Two slide-in module slots for installing power supply modules.

Side Panels

The left side panel of the Switch contains four system fans. The right side panel contains heat vents.

The system fans are used to dissipate heat. The sides of the system also provide heat vents to serve the same purpose. Do not block these openings, and leave adequate space at the rear and sides of the Switch for proper ventilation. Be reminded that without proper heat dissipation and air circulation, system components might overheat, which could lead to system failure.

Optional Plug-in Modules

The DES-6300 Modular Ethernet Switch is able to accommodate a range of plug-in modules in order to increase functionality and performance.

DES-6303 10BASE-T/100BASE-TX Module

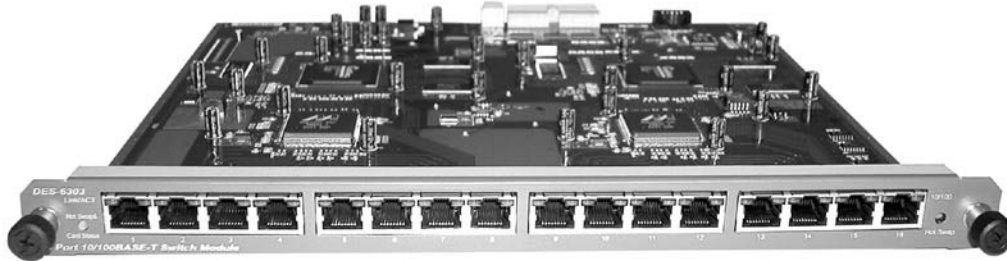

Figure 3-2. Sixteen-port, 10/100BASE-TX module

- ◆ Sixteen-port, front-panel module
- ◆ Connects to 10BASE-T and 100BASE-TX devices at full- or half-duplex
- ◆ Supports Category 3, 4, 5 or better UTP or STP connections of up to 100 meters each

DES-6304 100BASE-FX (MT-RJ) Module



Figure 3-3. Twelve-port, 100BASE-FX (MT-RJ) module

- ◆ Twelve-port, front-panel module
- ◆ Connects to 100BASE-FX devices at full- or half-duplex
- ◆ Twelve 100BASE-FX (MT-RJ) Fast Ethernet ports
- ◆ Fully compliant with IEEE 802.3u 100BASE-FX
- ◆ IEEE 802.3x compliant Flow Control support for full duplex

DES-6305 100BASE-FX (SC) Gigabit Module

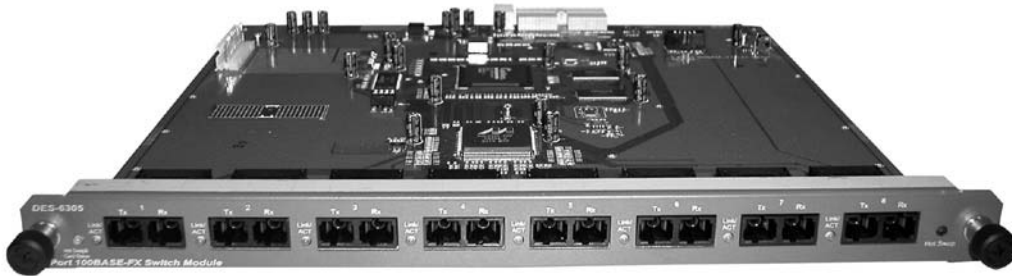

Figure 3-4. Eight-port, 100BASE-FX (SC) module

- ◆ Eight-port, front panel module
- ◆ Connects to a 100BASE-FX device at full duplex
- ◆ Eight 100BASE-FX (SC) ports
- ◆ Fully compliant with IEEE 802.3u
- ◆ Supports full-duplex operation only
- ◆ IEEE 802.3x-compliant Flow Control support

DES-6306 1000BASE-SX (SC) Gigabit Module

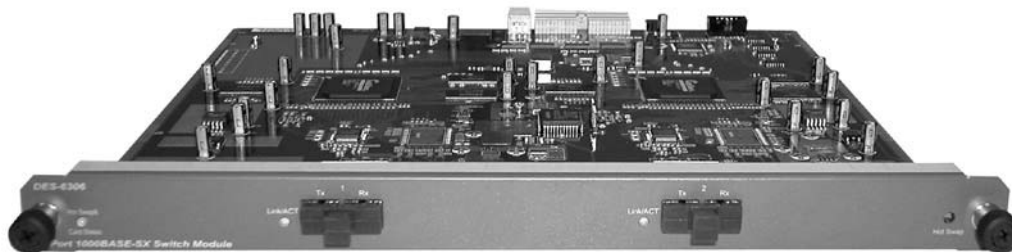

Figure 3-5. Two-port, 1000BASE-SX gigabit module

- ◆ Two-port, front-panel module
- ◆ Connects to 1000BASE-SX devices at full duplex
- ◆ Two 1000BASE-SX (SC) Gigabit Ethernet ports
- ◆ Fully compliant with IEEE 802.3z
- ◆ Support full-duplex operation only
- ◆ IEEE 802.3x-compliant Flow Control support

DES-6307 1000BASE-LX (SC) Gigabit Module

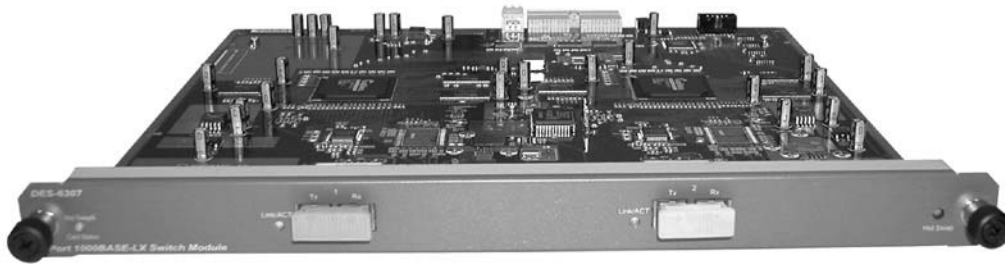

Figure 3- 6. Two-port, 1000BASE-LX gigabit module

- ◆ Two-port, front-panel module
- ◆ Connects to 1000BASE-LX devices at full duplex
- ◆ Two 1000BASE-LX (SC) Gigabit Ethernet ports
- ◆ Fully compliant with IEEE 802.3z
- ◆ Supports full-duplex operation only
- ◆ IEEE 802.3x-compliant Flow Control support

DES-6308 1000BASE-T (RJ-45) Module

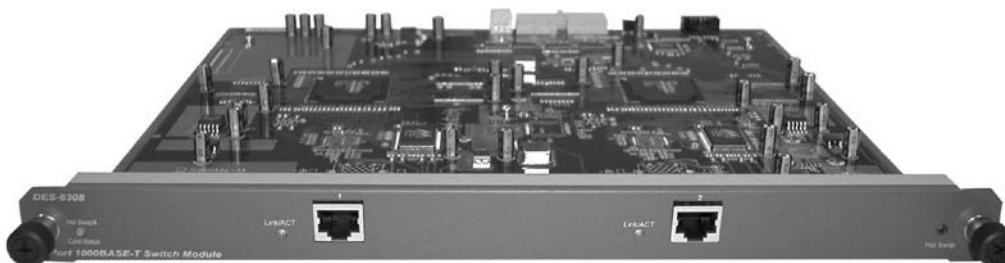

Figure 3- 7. Two-port, 1000BASE-T (RJ-45) module

- ◆ Two-port, front-panel module
- ◆ Connects to 1000BASE-T devices only at full duplex and auto-negotiating
- ◆ Two auto-sensing 10/100/1000 Mbps ports
- ◆ Fully compliant with IEEE 802.3ab
- ◆ Fully compliant with IEEE 802.1Q/P
- ◆ Back pressure Flow Control support for half-duplex mode
- ◆ IEEE 802.3x compliant Flow Control support for full duplex

DES-6309 GBIC Module

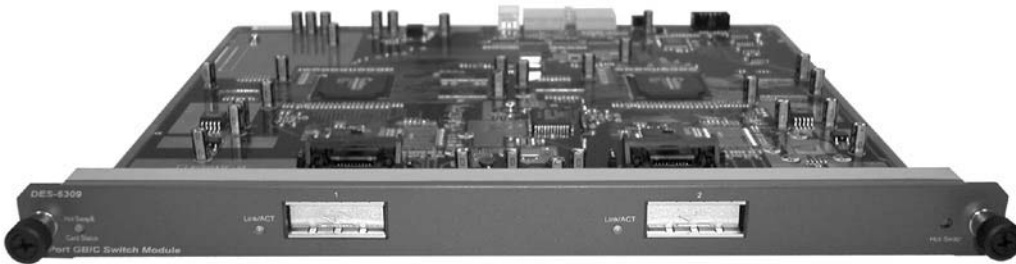

Figure 3- 8. Two-port GBIC Module

- ◆ Two-port, front-panel module
- ◆ Connects to GBIC devices at full duplex
- ◆ Two GBIC Ethernet ports
- ◆ Fully compliant with IEEE 802.3z
- ◆ Supports full-duplex operation only
- ◆ IEEE 802.3x-compliant Flow Control support

Power Supply Modules

- ◆ Dual power modules design with current sharing design
- ◆ Full redundant feature design to ensure continuous operation—if one power module fails, the other will take over all current supply automatically
- ◆ Hot-swappable/Hot-pluggable capability
- ◆ Power management functions
- ◆ Input: 90 ~ 264 VAC, 47 ~ 63Hz
- ◆ Output: 3.3V 80A maximum, 12V 2A maximum

LED Indicators

The LED indicators of the Switch include CPU Status and Power OK. The following shows the LED indicators for the Switch along with an explanation of each indicator.



Figure 3- 9. CPU Front Panel LED Indicators

◆ **CPU Status** – This center indicator on the front panel displays the current status of the switch. The LED will blink while the Power-On Self-Test (POST) is running during startup. It will light a steady green after the POST test to indicate the switch is powered on and operating properly. It will light amber when an error occurs during startup and the switch is therefore not functioning.

◆ **Power OK** – This indicator lights green when the CPU module of the switch is receiving power and functioning properly.

CONNECTING THE SWITCH

This chapter describes how to connect the Switch to your Ethernet network as well as providing an informational cable length table.

Switch to End Node

End nodes include PCs outfitted with a Network Interface Card (NIC) and most routers. For twisted-pair (copper) connections, the RJ-45 UTP ports on NICs and most routers are MDI-II. When using a normal straight-through cable, an MDI-II port must connect to an MDI-X port.

An end node can be connected to the Switch via a two-pair Category 3, 4, 5 UTP/STP straight cable (be sure to use Category 5 UTP or STP cabling for 100BASE-TX Fast Ethernet connections). The end node should be connected to any of the sixteen ports (1x - 16x) on the 10BASE-T/100BASE-TX module. The LED indicators for the port the end node is connected to are lit according to the capabilities of the NIC. If LED indicators are not illuminated after making a proper connection, check the PC's LAN card, the cable, switch conditions, and connections.

The following LED indicator states are possible for an end node to switch connection:

1. The 100M indicator comes *ON* for a 100 Mbps and stays *OFF* for 10 Mbps.
2. The Link/Act indicator lights up upon hooking up a PC that is powered on.

Switch to Hub or Switch

These connections can be accomplished in a number of ways. For twisted-pair (copper) connections, the most important consideration is that when using a normal, straight-through cable, the connection should be made between a normal crossed port (Port 1x, 2x, etc.) and an Uplink (MDI-II) port. If you are using a crossover cable, the connection can be made from a normal crossed port to another crossed port.

- ◆ A 10BASE-T hub or switch can be connected to the Switch via a two-pair Category 3, 4 or 5 UTP/STP straight cable.
- ◆ A 100BASE-TX hub or switch can be connected to the Switch via a four-pair Category 5 UTP/STP straight cable.

If the other switch or hub contains an unused Uplink port, we suggest connecting the other device's Uplink (MDI-II) port to any of the switch's (MDI-X) ports (1x - 16x 100BASE-TX ports).

If the other device does not have an unused Uplink port, make the connection with a crossover cable from any of the twisted-pair ports on the switch to any normal twisted-pair port on the hub.

10BASE-T Device

For a 10BASE-T device, the Switch's LED indicators should display the following:

- ◆ 100M speed indicator is *OFF*.

- ◆ Link/Act indicator is *ON*.

100BASE-TX Device

For a 100BASE-TX device, the Switch's LED indicators should display the following:

- ◆ 100M speed indicator is *ON*.
- ◆ Link/Act indicator is *ON*.

1000BASE-T Device

For a 1000BASE-T device, the Switch's LED indicators should display the following:

- ◆ Link/Act indicator is *ON*.

100BASE-FX Device

For a 100BASE-FX device, the Switch's LED indicators should display the following:

- ◆ Link/Act indicator is *ON*.

1000BASE-SX Device

For a 1000BASE-SX device, the Switch's LED indicators should display the following:

- ◆ Link/Act indicator is *ON*.

1000BASE-LX Device

For a 1000BASE-LX device, the Switch's LED indicators should display the following:

- ◆ Link/Act indicator is *ON*.

Cable Lengths

Standard	Media Type	MHz/km Rating	Maximum Distance
1000BASE-SX	50/125µm Multimode Fiber	400	500 Meters
	50/125µm Multimode Fiber	500	550 Meters
	62.5/125µm Multimode Fiber	160	220 Meters
	62.5/125µm Multimode Fiber	200	275 Meters
1000BASE-LX	50/125µm Multimode Fiber	400	500 Meters
	50/125µm Multimode Fiber	500	550 Meters
	62.5/125µm Multimode Fiber	500	550 Meters
	10µ Single-mode Fiber		5000 Meters
1000BASE-T	Category 5e UTP Cable (1000Mbps)		100 Meters
100BASE-FX	50/125µm Multimode Fiber (half-duplex operation)		400 Meters

	50/125µm Multimode Fiber (full-duplex operation)		2000 Meters
	62.5/125µm Multimode Fiber (half-duplex operation)		400 Meters
	52.5/125µm Multimode Fiber (full-duplex operation)		2000 Meters
100BASE-TX	Category 5 UTP Cable (100Mbps)		100 Meters
10BASE-T	Category 3 UTP Cable (10Mbps)		100 Meters

Table 4-1. Cable Lengths

SWITCH MANAGEMENT CONCEPTS

This chapter discusses many of the features used to manage the switch, and explains many concepts and important points regarding these features. Configuring the Switch to implement these concepts is discussed in detail in the next chapters.

IP Addresses and SNMP Community Names

Each Switch has its own IP Address, which is used for communication with an SNMP network manager or other TCP/IP application (for example BOOTP, TFTP, etc.). You must provide the switch with an IP Address to meet the specification of your networking address scheme.

In addition, you can also set an IP Address for a gateway router. This becomes necessary when the network management station is located on a different IP network as the Switch, making it necessary for management packets to go through a router to reach the network manager, and vice-versa.

For security, you can set in the Switch a list of IP Addresses of the network managers that you allow to manage the Switch. You can also change the default Community Name in the Switch and set access rights of these Community Names.

Traps

Traps are messages that alert you of events that occur on the Switch. The events can be as serious as a reboot (someone accidentally turned *OFF* the Switch), or less serious like a port status change. The Switch generates traps and sends them to the network manager (trap managers). The following lists the types of events that can take place on the Switch.

- ◇ System resets
- ◇ Errors
- ◇ Status changes
- ◇ Topology changes
- ◇ Operation

You can also specify which network managers may receive traps from the Switch by setting a list of IP Addresses of the authorized network managers.

Trap managers are special users of the network who are given certain rights and access in overseeing the maintenance of the network. Trap managers will receive traps sent from the Switch; they must immediately take certain actions to avoid future failure or breakdown of the network.

The following are trap types a trap manager will receive:

◆ **Cold Start** – This trap signifies that the Switch has been powered up and initialized such that software settings are reconfigured and hardware systems are rebooted. A cold start is different from a factory reset.

- ◆ **Authentication Failure** – This trap signifies that someone has tried to logon to the switch using an invalid SNMP community name. The switch automatically stores the source IP address of the unauthorized user.
- ◆ **Link Change Event** – This trap is sent whenever the link of a port changes from link up to link down or from link down to link up.
- ◆ **Power Fan1 Failure** – This trap is sent whenever one of the two fans on a redundant power supply module fails.
- ◆ **Power Fan2 Failure** – This trap is sent whenever one of the two fans on a redundant power supply module fails.
- ◆ **End TFTP** – This trap is sent when TFTP service ends.
- ◆ **Abort TFTP** – This trap is sent when TFTP service aborts.
- ◆ **Start TFTP** – This trap is sent when TFTP service starts.
- ◆ **VLAN Dynamic Port Added** – This trap is sent when a VLAN dynamic port is added.
- ◆ **VLAN Dynamic Port Removed** – This trap is sent when a VLAN dynamic port is removed.

MIBs

Management information and counters are stored in the Switch in the Management Information Base (MIB). The Switch uses the standard MIB-II Management Information Base module. Consequently, values for MIB objects can be retrieved from any SNMP-based network manager software. In addition to the standard MIB-II, the Switch also supports its own proprietary enterprise MIB as an extended Management Information Base. These MIBs may also be retrieved by specifying the MIB's Object-Identity (OID) at the network manager. MIB values can be either read-only or read-write.

Read-only MIBs variables can be either constants that are programmed into the Switch, or variables that change while the Switch is in operation. Examples of read-only constants are the number of ports and types of ports. Examples of read-only variables are the statistics counters such as the number of errors that have occurred, or how many kilobytes of data have been received and forwarded through a port.

Read-write MIBs are variables usually related to user-customized configurations. Examples of these are the Switch's IP Address, Spanning Tree Algorithm parameters, and port status.

If you use a third-party vendors' SNMP software to manage the Switch, a diskette listing the Switch's propriety enterprise MIBs can be obtained by request. If your software provides functions to browse or modify MIBs, you can also get the MIB values and change them (if the MIBs' attributes permit the write operation). This process however can be quite involved, since you must know the MIB OIDs and retrieve them one by one.

Packet Forwarding

The Switch learns the network configuration and uses this information to forward packets. This reduces the traffic congestion on the network, because packets, instead of being transmitted to all segments, are transmitted to the destination only. Example: if Port 1 receives a packet destined for a station on Port 2, the Switch transmits that packet through Port 2 only, and transmits nothing through the other ports.

Aging Time

The Aging Time is a parameter that affects the auto-learn process of the Switch in terms of the network configuration. Dynamic Entries, which make up the auto-learned-node address, are aged out of the address table according to the Aging Time that you set.

The Aging Time can be from 10 seconds to 9999 seconds. A very long Aging Time can result with the out-of-date Dynamic Entries that may cause incorrect packet filtering/forwarding decisions.

On the other hand, if the Aging Time is too short, many entries may be aged out soon, resulting in a high percentage of received packets whose source addresses cannot be found in the address table, in which case the Switch will broadcast the packet to all ports, negating many of the benefits of having a switch.

Filtering Database

A switch uses a filtering database to segment the network and control communications between segments. It also filters packets off the network for intrusion control (MAC Address filtering).

For port filtering, each port on the switch is a unique collision domain and the switch filters (discards) packets whose destination lies on the same port as where it originated. This keeps local packets from disrupting communications on other parts of the network.

For intrusion control, whenever a switch encounters a packet originating from or destined to a MAC address defined by the user, the switch will discard the packet.

Filtering includes:

Dynamic filtering – Automatic learning and aging of MAC addresses and their location on the network. Filtering occurs to keep local traffic confined to its segment.

MAC address filtering – The manual entry of specific MAC addresses to be filtered from the network.

Filtering done by the Spanning Tree Protocol – Able to filter packets based on topology, making sure that signal loops don't occur.

Filtering done for VLAN integrity – Packets from a member of a VLAN (VLAN 2, for example) destined for a device on another VLAN (VLAN 3) will be filtered.

Spanning Tree Algorithm

The Spanning Tree Algorithm (STA) in the Switch allows you to create alternative paths (with multiple switches or other types of bridges) in your network. These backup paths are idle until the Switch determines that a problem has developed in the primary paths. When a primary path is lost, the switch providing the alternative path will automatically go into service with no operator intervention. This automatic network reconfiguration provides maximum uptime to network users. The concept of the Spanning Tree Algorithm is a complicated and complex subject and must be fully researched and understood. Please read the following before making any changes.

Network loop detection and prevention – With STA, there will be only one path between any two LANs. If there is more than one path, forwarded packets will loop indefinitely. STA detects any looped path and selects the path with the lowest path cost as the active path, while blocking the other path and using it as the backup path.

Automatic topology re-configuration – When the path for which there is a backup path fails, the backup path will be automatically activated, and STA will automatically re-configure the network topology.

STA Operation Levels

STA operates on two levels: the bridge level and the port level. On the bridge level, STA calculates the Bridge Identifier for each Switch, then sets the Root Bridge and the Designated Bridges. On the port level, STA sets the Root Port and Designated Ports. Details are as follows:

On the Bridge Level

Root Bridge – The switch with the lowest Bridge Identifier is the Root Bridge. Naturally, you will want the Root Bridge to be the best switch among the switches in the loop to ensure the highest network performance and reliability.

Bridge Identifier – This is the combination of the Bridge Priority (a parameter that you can set) and the MAC address of the switch. Example: 4 00 80 c8 00 01 00, where 4 is the Bridge Priority. A lower Bridge Identifier results in a higher priority for the switch, and thus increases it probably of being selected as the Root Bridge.

Designated Bridge – From each LAN segment, the attached Bridge that has the lowest Root Path Cost to the Root Bridge is the Designated Bridge. It forwards data packets for that LAN segment. In cases where all Switches have the same Root Path Cost, the switch with the lowest Bridge Identifier becomes the Designated Bridge.

Root Path Cost – The Root Path Cost of a switch is the sum of the Path Cost of the Root Port and the Root Path Costs of all the switches that the packet goes through. The Root Path Cost of the Root Bridge is zero.

Bridge Priority – This is a parameter that users can set. The smaller the number you set, the higher the Bridge Priority is. The higher the Bridge Priority, the better the chance the Switch will be selected as the Root Bridge.

On the Port Level

Root Port – Each switch has a Root Port. This is the port that has the lowest Path Cost to the Root Bridge. In case there are several such ports, then the one with the lowest Port Identifier is the Root Port.

Designated Port – This is the port on each Designated Bridge that is attached to the LAN segment for which the switch is the Designated Bridge.

Port Priority – The smaller this number, the higher the Port Priority is. With higher Port Priority, the higher the probability that the port will be selected as the Root Port.

Path Cost – This is a changeable parameter and may be modified according to the STA specification. The 1000Mbps segment has an assigned Path Cost of 4, the 100Mbps segment has an assigned Path Cost of 19, and each 10Mbps segment has an assigned Path Cost of 100, based on the STA specifications.

User-Changeable STA Parameters

The factory default setting should cover the majority of installations. However, it is advisable to keep the default settings as set at the factory, unless it is absolutely necessary. The user changeable parameters in the Switch are as follows:

Bridge Priority – A Bridge Priority can be from 0 to 65535. 0 is equal to the highest Bridge Priority.

Bridge Hello Time – The Hello Time can be from 1 to 10 seconds. This is the interval between two transmissions of BPDU packets sent by the Root Bridge to tell all other Switches that it is indeed the Root Bridge. If you set a Hello Time for your Switch, and it is not the Root Bridge, the set Hello Time will be used if and when your Switch becomes the Root Bridge.

Note: The Hello Time cannot be longer than the Max. Age. Otherwise, a configuration error will occur.

Bridge Max. Age – The Max. Age can be from 6 to 40 seconds. At the end of the Max. Age, if a BPDU has still not been received from the Root Bridge, your Switch will start sending its own BPDU to all other Switches for permission to become the Root Bridge. If it turns out that your Switch has the lowest Bridge Identifier, it will become the Root Bridge.

Bridge Forward Delay – The Forward Delay can be from 4 to 30 seconds. This is the time any port on the Switch spends in the listening state while moving from the blocking state to the forwarding state.

Observe the following formulas when you set the above parameters:

$$\text{Max. Age} \leq 2 \times (\text{Forward Delay} - 1 \text{ second})$$

$$\text{Max. Age} \geq 2 \times (\text{Hello Time} + 1 \text{ second})$$

Port Priority – A Port Priority can be from 0 to 255. The lower the number, the greater the probability the port will be chosen as the Root Port.

Illustration of STA

A simple illustration of three Bridges (or the Switch) connected in a loop is depicted in *Figure 5-1*. In this example, you can anticipate some major network problems if the STA assistance is not applied. For instance, if Bridge 1 broadcasts a packet to Bridge 2, Bridge 2 will broadcast it to Bridge 3, and Bridge 3 will broadcast it to Bridge 1 and so on. The broadcast packet will be passed indefinitely in a loop, causing a serious network failure.

To alleviate network loop problems, STA can be applied as shown in *Figure 5-2*. In this example, STA breaks the loop by blocking the connection between Bridge 1 and 2. The decision to block a particular connection is based on the STA calculation of the most current Bridge and Port settings. Now, if Bridge 1 broadcasts a packet to Bridge 3, then Bridge 3 will broadcast it to Bridge 2 and the broadcast will end there.

STA setup can be somewhat complex. Therefore, you are advised to keep the default factory settings and STA will automatically assign root bridges/ports and block loop connections. However, if you need to customize the STA parameters, refer to *Table 5-1*.

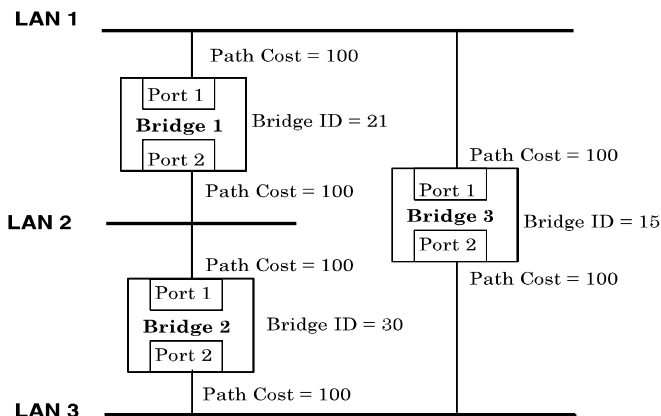

Figure 5-1. Before Applying the STA Rules

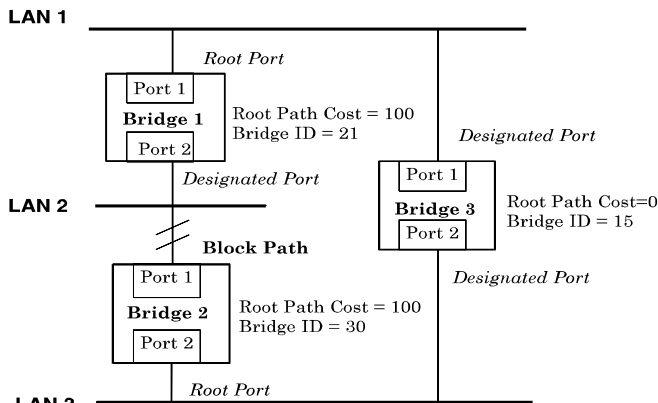

Figure 5-2. After Applying the STA Rules

STA parameters	Settings	Effects	Comment
Bridge Priority	lower the #, higher the priority	Increases chance of becoming the Root Bridge	Avoid, if the switch is used in workgroup level of a large network
Hello Time	1 - 10 sec.	No effect, if not Root Bridge	Never set greater than Max. Age Time
Max. Age Time	6 - 40 sec.	Compete for Root Bridge, if BPDU is not received	Avoid low number for unnecessary reset of Root Bridge
Forward Delay	4 - 30 sec.	High # delays the change in state	Max. Age $\leq 2 \times$ (Forward Delay - 1) Max. Age $\geq 2 \times$ (Hello Time + 1)
Port Level STA parameters			
Enable/Disable	Enable/Disable	Enable or disable this LAN segment	Disable a port for security or problem isolation
Port Priority	lower the #, higher the priority	Increases chance of become Root Port	

Table 5-1. User-selective STA parameters

Port Trunking

Port trunking is used to combine a number of ports together to make a single high-bandwidth data pipeline. The participating parts are called members of a trunk group, with one port designated as the *anchor* of the group. Since all members of the trunk group must be configured to operate in the same manner, all settings changes made to the anchor port are applied to all members of the trunk group. Thus, when configuring the ports in a trunk group, you only need to configure the anchor port.

The Switch supports up to 16 trunk groups. Each module on the switch supports up to two trunk groups except gigabit modules, which support a single trunk group. The Switch treats all ports in a trunk group as a single port. As such, trunk ports will not be blocked by Spanning Tree.

Data transmitted to a specific host (destination address) will always be transmitted over the same port in a trunk group. This allows packets in a data stream to arrive in the same order they were sent. A trunk connection can be made with any other switch that maintains host-to-host data streams over a

single trunk port. Switches that use a load-balancing scheme that sends the packets of a host-to-host data stream over multiple trunk ports cannot have a trunk connection with the Switch.

VLANs & Broadcast Domains

VLANs are a collection of users or switch ports grouped together in a secure, autonomous broadcast and multicast domain. The main purpose of setting up VLANs on a network is to limit the range and effects of broadcast packets, which can develop into broadcast storms and seriously impair network performance.

Three types of VLANs and broadcast domains are implemented on the switch: 802.1Q VLANs, port-based VLANs, and MAC-based broadcast domains. Only one of the three types can be active on the switch at any given time, however. Thus, you will need to choose the type of VLAN or broadcast domain you wish to setup on your network and configure the switch accordingly. MAC-based broadcast domains and port-based VLANs are limited to the switch and devices directly connected to it, while 802.1Q VLANs support IEEE 802.1Q tagging, which enables them to span the entire network (assuming all switches on the network are IEEE 802.1Q-compliant).

All VLANs allow a network to be segmented in order to reduce the size of broadcast domains. All broadcast, multicast, and unknown packets entering the switch on a particular VLAN or broadcast domain will only be forwarded to the stations (MAC-based) or ports (802.1Q and Port-based) that are members of that VLAN or broadcast domain. 802.1Q VLANs can also be setup to limit unicast packets to members of a particular VLAN, thus providing a degree of security to your network.

Another benefit of 802.1Q and port-based VLANs is that you can change the network topology without physically moving stations or changing cable connections. Stations can be 'moved' to another VLAN and thus communicate with members and share resources on the new VLAN, simply by changing the port VLAN settings from one VLAN (the sales VLAN, for example) to another VLAN (the marketing VLAN). This allows VLANs to accommodate network moves, changes and additions with the utmost flexibility. MAC-based broadcast domains, on the other hand, allow a station to be physically moved yet still belong to the same broadcast domain without having to change configuration settings.

The *untagging* feature of IEEE 802.1Q VLANs allows VLANs to work with legacy switches and NICs that don't recognize VLAN tags in packet headers. The *tagging* feature allows VLANs to span multiple 802.1Q-compliant switches through a single physical connection and allows Spanning Tree to be enabled on all ports and work normally.

MAC-based Broadcast Domains

The Switch supports up to 12 MAC-based broadcast domains, which are by their nature, limited to the switch itself and the devices connected directly to it.

Since MAC addresses are hard-wired into a station's network interface card (NIC), MAC-based broadcast domains enable network managers to move a station to a different physical location on the network and have that station automatically retain its broadcast domain membership. This provides the network with a high degree of flexibility since even notebook PC's can plug into any available port on a network and communicate with the same people and use the same resources that have been allocated to the broadcast domain in which it is a member.

Since MAC-based broadcast domains do not restrict the transmission of known unicast frames to other broadcast domains, they can only be used to define limited broadcast domains. As such, they are best implemented on networks where stations are frequently moving, for example where people using notebook PCs are constantly plugging into different parts of the network.

Setting up MAC-based broadcast domains is a relatively straight-forward process. Simply create the broadcast domain by assigning it a name (description) and add MAC addresses for the stations that will be members.

802.1Q VLANs

The Switch supports up to 2048 802.1Q VLANs. 802.1Q VLANs limit traffic that flows into and out of switch ports. Thus, all devices connected to a port are members of the VLAN(s) the port belongs to, whether there is a single computer directly connected to a switch, or an entire department.

On 802.1Q VLANs, NICs do not need to be able to identify 802.1Q tags in packet headers. NICs send and receive normal Ethernet packets. If the packet's destination lies on the same segment, communications take place using normal Ethernet protocols. Even though this is always the case, when the destination for a packet lies on another Switch port, VLAN considerations come into play to decide if the packet gets dropped by the Switch or delivered.

There are two key components to understanding 802.1Q VLANs; Port VLAN ID numbers (PVIDs) and VLAN ID numbers (VIDs). Both variables are assigned to a switch port, but there are important differences between them. A user can only assign one PVID to each switch port. The PVID defines which VLAN a packet belongs to when packets need to be forwarded to another switch port or somewhere else on the network. On the other hand, a user can define a port as a member of multiple VLANs (VIDs), allowing the segment connected to it to receive packets from many VLANs on the network. These two variables control a port's ability to transmit and receive VLAN traffic, and the difference between them provides network segmentation, while still allowing resources to be shared across more than one VLAN.

802.1Q VLAN Segmentation

The following example is helpful in explaining how 802.1Q VLAN segmentation works. Take a packet that is transmitted by a machine on Port 1 that is a member of VLAN 2 and has the Port VLAN ID number 2 (PVID=2). If the destination lies on another port (found through a normal forwarding table lookup), the Switch then looks to see if the other port (Port 10) is a member of VLAN 2 (and can therefore receive VLAN 2 packets). If port 10 is not a member of VLAN 2, then the packet will be dropped by the Switch and will not reach its destination. If Port 10 is a member of VLAN 2, the packet will go through. This selective forwarding feature based on VLAN criteria is how VLANs segment networks. The key point being that Port 1 will only transmit on VLAN 2, because it's Port VLAN ID number is 2 (PVID=2).

Sharing Resources Across 802.1Q VLANs

Network resources such as printers and servers however, can be shared across 802.1Q VLANs. This is achieved by setting up overlapping VLANs as shown in the diagram below.

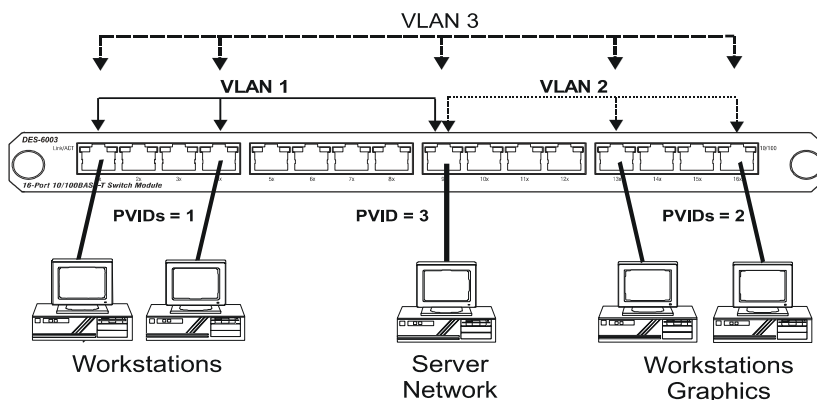

Figure 5-3. Example of typical VLAN configuration

In the above example, there are three different 802.1Q VLANs and each port can transmit packets on one of them according to their Port VLAN ID (PVID). However, a port can receive packets on all VLANs (VID) that it belongs to. The assignments are as follows:

Port	PVID
Port 1	1
Port 4	1
Port 13	2
Port 16	2
Port 9	3

Ports	VID
1,4,9	1
9,13,16	2
1,4,9,13, 16	3

Table 5-2. VLAN assignments for Figure 5-4

The server attached to Port 9 is shared by VLAN 1 and VLAN 2 because Port 9 is a member of both VLANs (it is listed as a member of VID 1 and 2). Since it can receive packets from both VLANs, all ports can successfully send packets to it. Ports 1 and 4 send these packets on VLAN 1 (their PVID=1), and Ports 13 and 16 send these packets on VLAN 2 (PVID=2). The third VLAN (PVID=3) is used by the server to transmit files that had been requested on VLAN 1 or 2 back to the computers. All computers that use the server will receive transmissions from it since they are all located on ports which are members of VLAN 3 (VID=3).

802.1Q VLANs Spanning Multiple Switches

802.1Q VLANs can span multiple switches as well as your entire network. Two considerations to keep in mind while building VLANs of this sort are whether the switches are IEEE 802.1Q-compliant and whether VLAN packets should be tagged or untagged.

Definitions of relevant terms are as follows:

- ◆ **Tagging** – The act of putting 802.1Q VLAN information into the header of a packet. Tagging ports will put the VID number, priority, and other VLAN information into all packets that flow into and out of it. If a packet has previously been tagged, the port will not alter the packet, thus keeping the VLAN information intact. Tagging is used to send packets from one 802.1Q-compliant device to another.
- ◆ **Untagging** – The act of stripping 802.1Q VLAN information out of the packet header. Untagging ports will take all VLAN information out of all packets that flow into and out of a port. If the packet doesn't have a VLAN tag, the port will not alter the packet, thus keeping the packet free of VLAN information. Untagging is used to send packets from an 802.1Q-compliant switch to a non-compliant device.
- ◆ **Ingress port** – A port on a switch where packets are flowing into the switch. If an ingress port has the Ingress Filter enabled, the switch will examine each packet to determine whether or not it is a VLAN member and then take one of two actions: if the port is not a member of a VLAN, the packet will be dropped; if the port is a member of a VLAN, then the packet will be forwarded. Otherwise, if the Ingress Filter is disabled, then the switch will process any packet received at this port in its normal fashion.
- ◆ **Egress port** – A port on a switch where packets are flowing out of the switch, either to another switch or to an end station, and tagging decisions must be made. If an egress port is connected to an 802.1Q-compliant device, tagging should be enabled so the other device can take VLAN data into account when making forwarding decisions (this allows VLANs to span multiple switches). If an egress connection is to a non-compliant switch or end-station, tags should be stripped so the (now normal Ethernet) packet can be read by the receiving device.

VLANs Over 802.1Q-compliant Switches

When switches maintaining the same VLANs are 802.1Q-compliant, it is possible to use tagging. Tagging puts 802.1Q VLAN information into each packet header, enabling other 802.1Q-compliant switches that receive the packet to know how to treat it. Upon receiving a tagged packet, an 802.1Q-compliant switch can use the information in the packet header to maintain the integrity of VLANs, carry out priority forwarding, etc.

Data transmissions between 802.1Q-compliant switches take place as shown below.

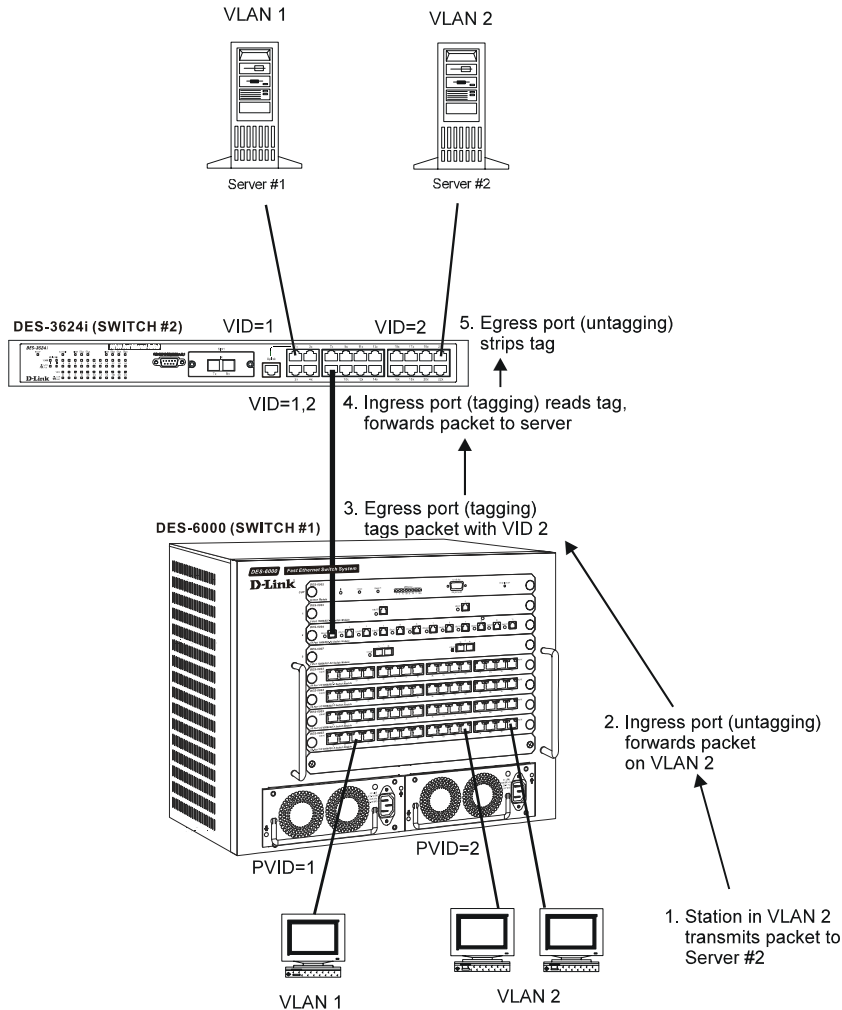

Figure 5-4. Data transmissions between 802.1Q-compliant switches

In the above example, step 4 is the key element. Because the packet has 802.1Q VLAN data encoded in its header, the ingress port can make VLAN-based decisions about its delivery: whether server #2 is attached to a port that is a member of VLAN 2 and thus, should the packet be delivered; the queuing priority to give to the packet, etc. It can also perform these functions for VLAN 1 packets as well, and, in fact, for any tagged packet it receives regardless of the VLAN number.

If the ingress port in step 4 were connected to a non-802.1Q-compliant device and was thus receiving untagged packets, it would tag its own PVID onto the packet and use this information to make forwarding decisions. As a result, the packets coming from the non-compliant device would automatically be placed on the ingress ports VLAN and could only communicate with other ports that are members of this VLAN.

Port-based VLANs

In port-based VLANs, broadcast, multicast and unknown packets will be limited to within the VLAN. Thus, port-based VLANs effectively segment your network into broadcast domains. Furthermore, ports can only belong to a single VLAN.

Because port-based VLANs are uncomplicated and fairly rigid in their implementation, they are best used for network administrators who wish to quickly and easily set up VLANs in order to limit the effect of broadcast packets on their network.

For the most secure implementation, make sure that end stations are directly connected to the switch. Attaching a hub, switch or other repeater to a port causes all stations attached to the repeater to become members of the Port-based VLAN.

To setup port-based VLANs, simply select one of 24 VLAN ID numbers, name the VLAN and specify which ports will be members. All other ports will automatically be forbidden membership, even dynamically as a port can belong to only one VLAN.

Broadcast Storms

Broadcast storms are a common problem on today's networks. Basically, they consist of broadcast packets that flood and/or are looped on a network causing noticeable performance degradation and, in extreme cases, network failure. Broadcast storms can be caused by network loops, malfunctioning NICs, bad cable connections, and applications or protocols that generate broadcast traffic, among others.

In effect, broadcast storms can originate from any number of sources, and once they are started, they can be self-perpetuating, and can even multiply the number of broadcast packets on the network over time. In the best case, network utilization will be high and bandwidth limited until the hop counts for all broadcast packets have expired, whereupon the packets will be discarded and the network will return to normal. In the worst case, they will multiply, eventually using up all the network bandwidth (although network applications will usually crash long before this happens), and cause a network meltdown.

Broadcast storms have long been a concern for network administrators with routers traditionally being used to prevent their occurrence, and if that failed, to at least limit their scope. However, with the advent of VLANs, switches are now able to limit broadcast domains better and cheaper than routers. Also, many switches, including the DES-6300 series, have broadcast sensors and filters built into each port to further control broadcast storms.

Segmenting Broadcast Domains

VLANs can be used to segment broadcast domains. They do this by forwarding packets only to ports in the same VLAN. Thus, broadcast packets will only be forwarded to ports that are members of the same VLAN. Other parts of the network are effectively shielded. As a result, the smaller the broadcast domain, the less effect a broadcast storm will have. Because VLANs are implemented at each switch port, they can be quite effective in limiting the scope of broadcast storms.

Eliminating Broadcast Storms

SNMP agents can be programmed to monitor the number of broadcast packets on switch ports and act on the data. When the number of broadcast packets on a given port rise past an assigned threshold, an action can be triggered. When enabled, the usual action is to block the port to broadcast frames, which discards all broadcast frames arriving at the port from the attached segment. Not only does this isolate the broadcast domain, but it actually starts removing broadcast packets from the affected segment. When the number of broadcast packets falls to an acceptable level (below a *falling threshold*), the SNMP agent can remove the blocking condition, returning the port to its normal operational state.

In the DES-6300 switch, the default rising threshold is met when more than 500 broadcast packets per second are being detected on a specified port. Once the rising threshold is surpassed for a duration of more than 5 seconds, it will trigger the broadcast storm rising action configured by the user. The default falling threshold is met if there are less than 250 broadcast packets per second. It is triggered once the duration is at least 30 seconds. The actions can easily be defined by using a normal SNMP management program or through the console interface.

USING CONFIGMASTER

ConfigMaster is an intricate SNMP-based network management system that operates as an applet and as an application. ConfigMaster configures, monitors, and troubleshoots networking devices both locally at the management console, or remotely using a standard Web browser. ConfigMaster provides real-time graphs from a wide selection of MIB variables that help monitor device performance.

ConfigMaster is accessed through a Graphic User Interface (GUI) that displays the actual device front panel. The panel indicators, such as the LEDs, are mirrored to the front panel display and are viewed by the network manager.

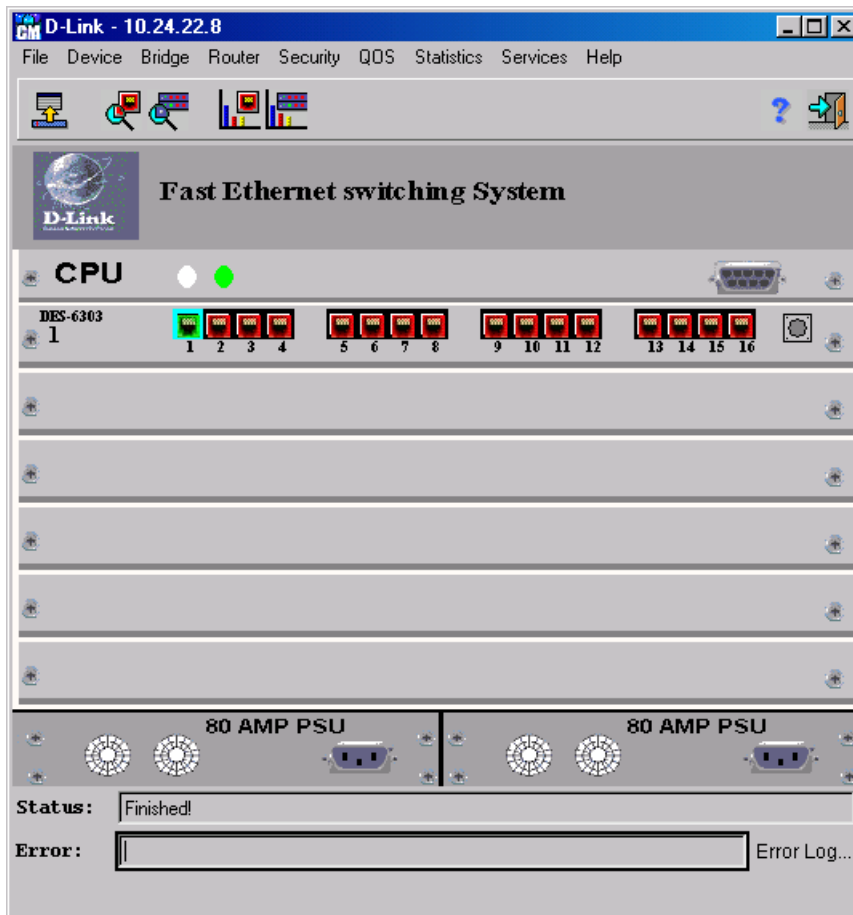

The main window displayed above is used for managing ConfigMaster. It also contains general information about other ConfigMaster windows and buttons, and describes how to add optional features to devices.

Installation

General System Requirements

To effectively operate ConfigMaster, the system requires that hardware and software meet system requirements.

Hardware Requirements

The hardware requirements are as follows:

- ◆ Pentium-based Machine.
- ◆ Windows NT 4.0, Windows 95, Windows 98, Windows ME, or Windows 2000 (Service Pack).
- ◆ 32MB RAM (64MB RAM or more is recommended).
- ◆ 50 MB Hard Disk Space.
- ◆ CD-ROM Drive.
- ◆ 800x600 (minimum recommended) Screen Resolution.

Software Requirements

The software requirements are as follows:

- ◆ Netscape Communicator Version 4.5 or above.
- or
- ◆ Microsoft Internet Explorer Version 5.0 or above.
 - ◆ Java Virtual Machine supporting Java version 1.1.7 and above.

In addition, ConfigMaster runs with:

- ◆ Sun JVM (JRE).

The DES-6300 has been verified to run with Microsoft's JVM (Wjview) and Sun's JVM (jREw). In case of JRE, we recommend not to use version 1.1.7A because of a known bug. If you decide to use SUN's JVM, it is included on the CD-ROM- "Util\Tools\jre117Bi-win32.exe".

If you don't have a JVM, you can download one of the following:

Sun's JVM (JRE) – <http://java.sun.com/products/jdk/1.1/jre/index.html>

Microsoft JVM (Jview) (comes with Microsoft Internet Explorer version 4.01 or above) –
<http://www.microsoft.com/windows/ie/download>

To download just the Java Virtual Machine from Microsoft download the latest Microsoft VM from
http://www.microsoft.com/java/vm/dl_vm40.htm

Note for Windows 2000 users only: *The Microsoft VM is included with the Windows 2000 operating system and can only be updated with a Windows 2000 hotfix or service pack release. A description of the Windows 2000 Windows File Protection (WFP) feature can be found in Microsoft Knowledge Base (KB) article number Q222193.*

Installing ConfigMaster

To install ConfigMaster:

1. The opening ConfigMaster **Authentication key** window is:

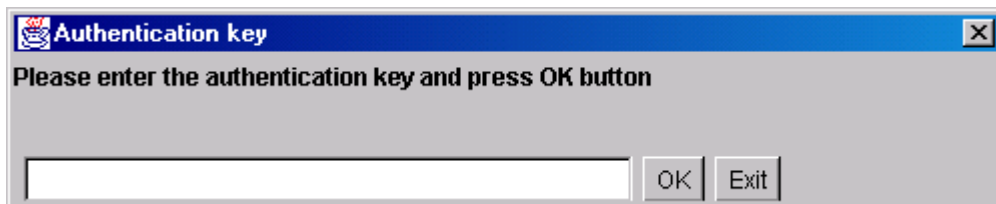

Figure 6- 1. Authentication key window

2. Enter the authentication key and press . The **ConfigMaster Setup** window opens:

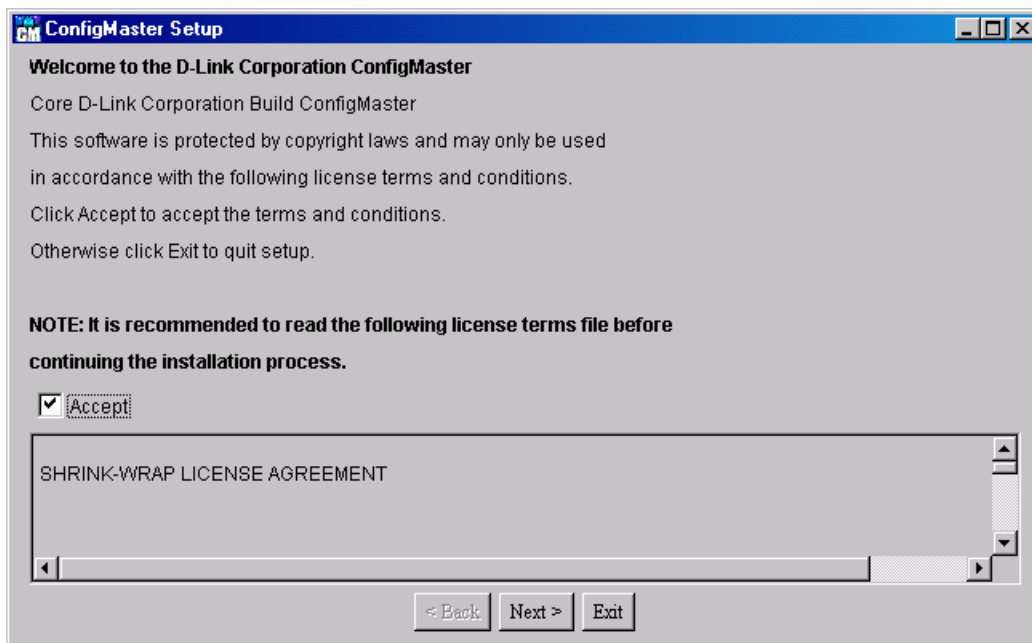



Figure 6- 2. ConfigMaster Setup window

3. Check the Accept checkbox and press . The **Selecting the Installation Directory** window opens:

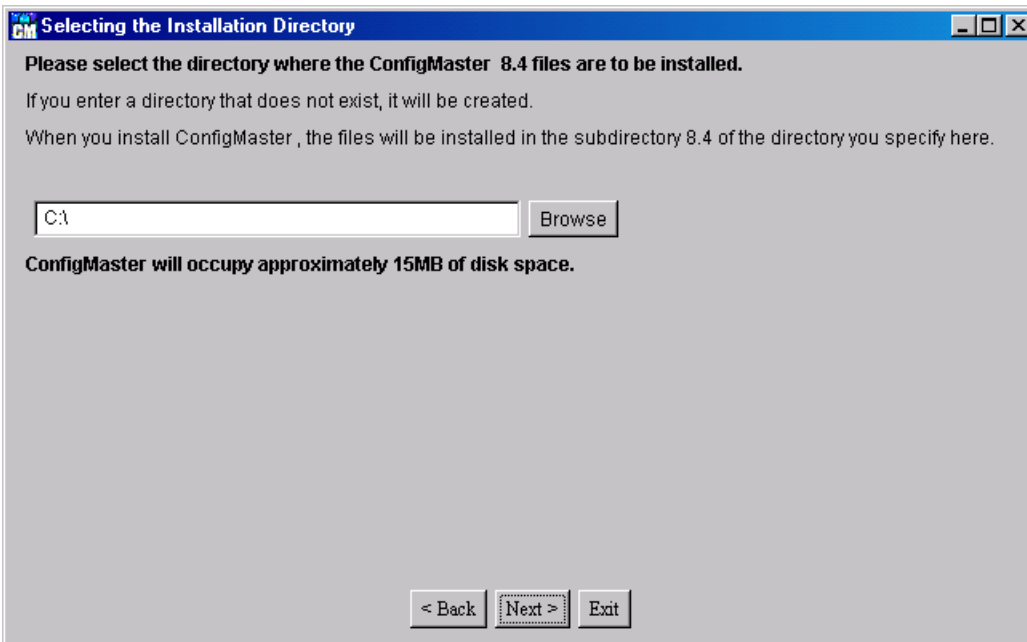



Figure 6-3. Selecting the Installation Directory window

4. Enter the installation path and directory where you want to install ConfigMaster and press . If the directory entered does not exist, the system automatically creates it. The default installation directory is c:/program files/. The **Selecting the Internet Browser** window opens:

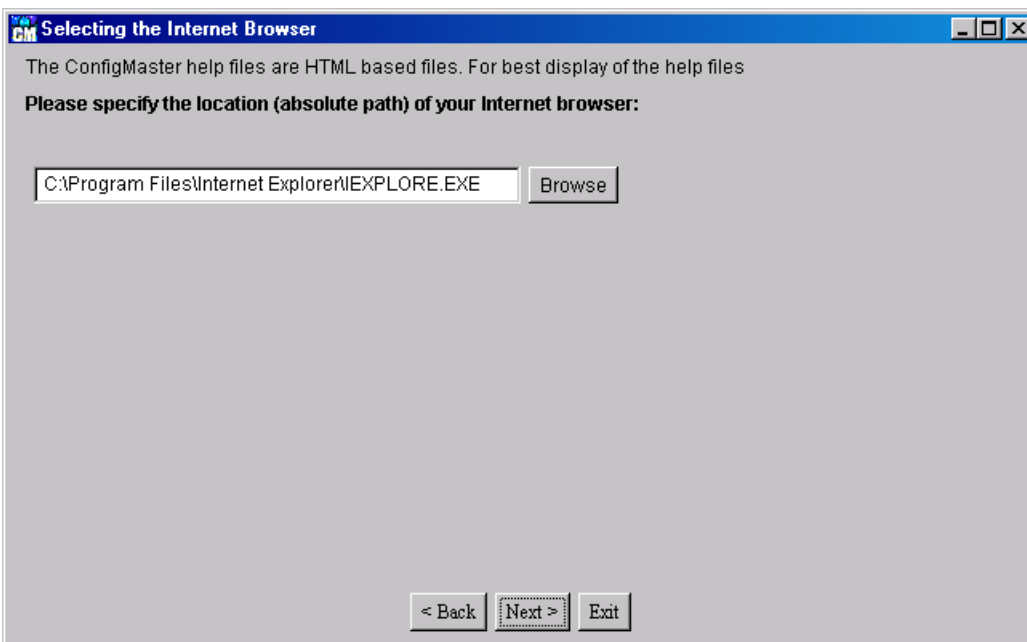

Figure 6-4. Selecting the Internet Browser window

5. Enter the Internet browser path and press . The **Setting the Java Interpreter** window opens:

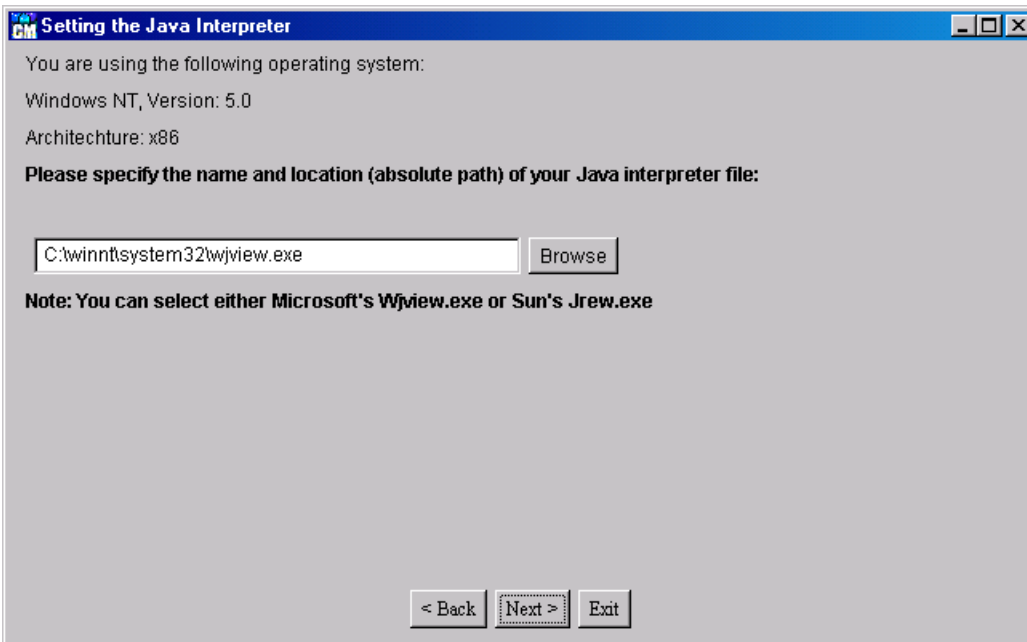



Figure 6- 5. Selecting the Java Interpreter window

6. Enter the Java Interpreter absolute path. The default location appears in the textbox. Enter the path of the file:
 - ◆ Sun Java Interpreter—jrew.exe.

or

 - ◆ Microsoft Java Interpreter—wjview.exe for Microsoft Internet Explorer.
7. Press . The **Device List** window opens:

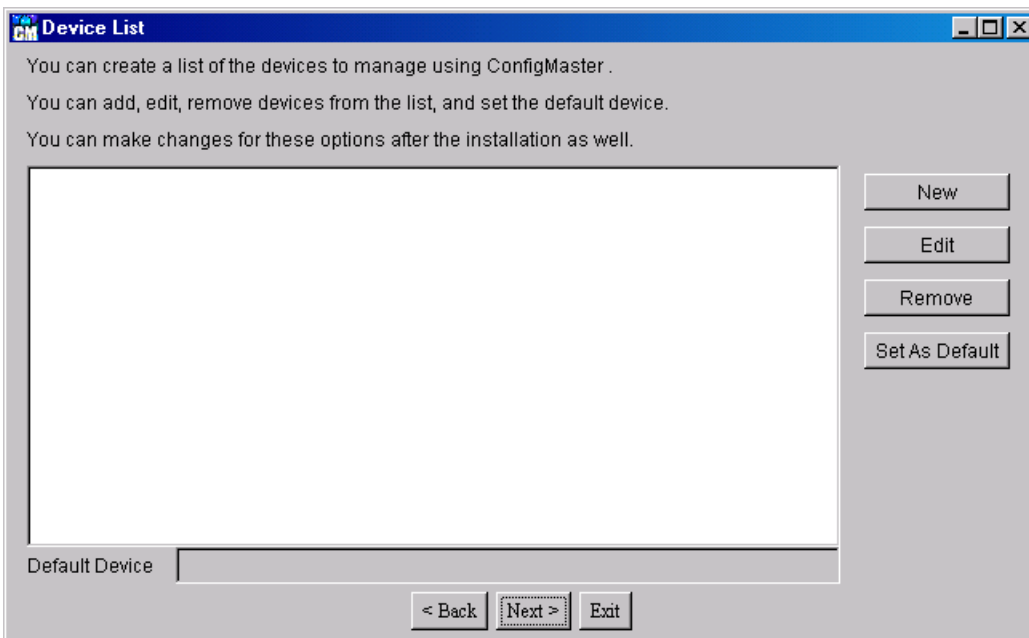

Figure 6- 6. Device List window

8. If required, create a list of devices (name and IP addresses) to facilitate device connection when running ConfigMaster. A default device can be set as the selected device.

Note: The Device List can be edited through the ConfigMaster menu. The Device List is edited through **Options->Configuration->Device List**.

9. Press **Next >**. The **Create Desktop and "Start Menu" Shortcut** window opens:

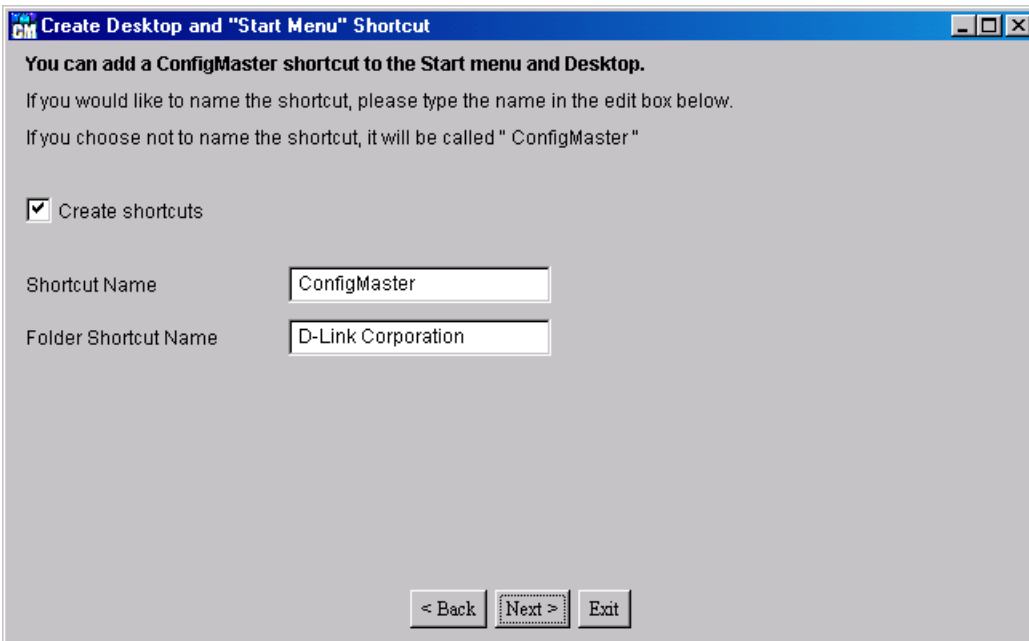

Figure 6- 7. Create Desktop and "Start Menu" Shortcut window

10. Specify a name for the ConfigMaster Desktop shortcut and for the Start Menu shortcuts folder. If a shortcut is not required, uncheck the Create shortcuts checkbox.
11. After checking the summary of the information, click **Next >**. To make corrections, click **< Back**. The **Installation Summary** window opens:

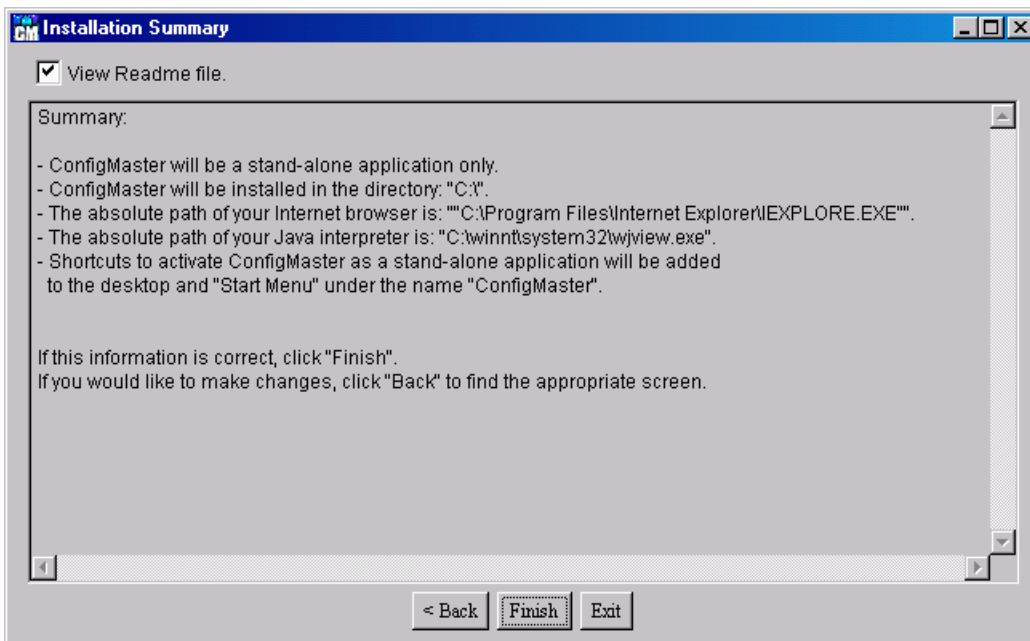

Figure 6- 8. Installation Summary window

12. Check the summary and if all the information is correct click **Finish**. If the information is incorrect, click **< Back** until the desired window displays. Modify the information and click **Next >** until the **Installation Summary** window opens.
13. Click **Finish**. The installation process begins. When the installation process ends the **ConfigMaster README File** window opens:

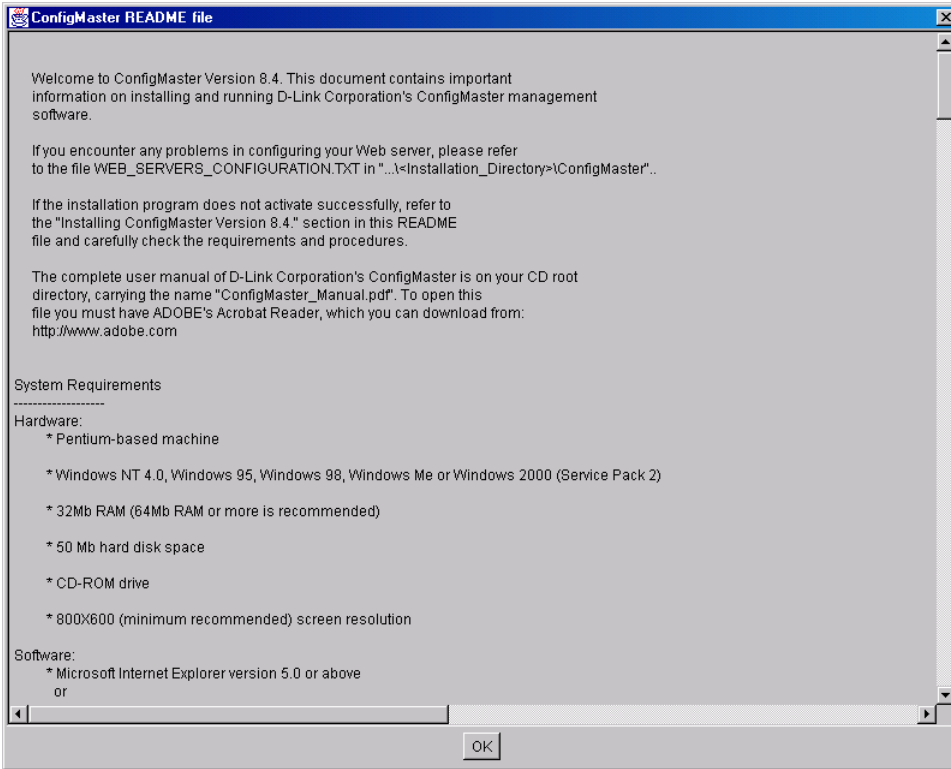



Figure 6- 9. ConfigMaster README file window

14. Click **OK**. The **Finished Installation** window opens:



Figure 6- 10. Finished Installation window

During installation, a script file called `ConfigMaster.bat` is created in the `\<Installation_Directory>\ConfigMaster\NMS` directory. This script file activates ConfigMaster as a Standalone application. Alternatively, double-click  on the Desktop.

Uninstalling ConfigMaster

Uninstall removes ConfigMaster and all of its components, including the configuration directory and its contents.

Note: *Duplicate important files saved in the installation directory before uninstalling ConfigMaster.*

To uninstall ConfigMaster:

1. Select **Start > Programs > D-Link Corporation** (or the folder chosen as the default folder while installing ConfigMaster).
2. Click **Uninstall**. The ConfigMaster files are removed from your computer.

Reinstalling ConfigMaster

To re-install ConfigMaster:

- ◆ Install the new software version without uninstalling the current version, unless the current version is older than version 6.4.
- ◆ For versions older than 6.4, ConfigMaster must first be uninstalled.

The installation procedure provides the existing program defaults and device lists. Files saved in the installation directory, such as the configuration files, are not erased from the disk.

Troubleshooting

ConfigMaster provides troubleshooting answers for the following issues that may arise when installing ConfigMaster:

- ◆ Very Slow Directory Discovery.
- ◆ Poor Web Performance With Windows 95.
- ◆ Cannot View Tables When Using A Browser.
- ◆ Local Intranet Use.
- ◆ ConfigMaster.bat Does Not Activate ConfigMaster.

Very Slow Directory Discovery

When clicking **Browse** to browse for a directory, the program detects all the drives defined on the system. If there is a slow network connection to any of these drives, it takes a few seconds until the browse window displays.

Poor Web Performance With Windows 95

Poor Web performance of ConfigMaster on Windows 95 may be caused by a problem in the Windows 95 winsock. There is a Microsoft patch to rectify the problem. This patch is on the ConfigMaster CD `Tools\W95ws2setup.exe`. The patch can be downloaded from the Microsoft site: <http://www.microsoft.com/windows/downloads/contents/Updtes/W95Sockets2>. Read the `Tools\winsock2License.txt` file before using this patch.

Cannot View Tables When Using A Browser

There are some compatibility problems between Microsoft and Sun JVMs (Java Virtual Machines). There could be a problem using one JVM as a client (Sun Netscape Browser or HotJava and Microsoft Internet Explorer), and the other as a server (Sun Jrew and Microsoft Wjview).

To avoid compatibility problems, ensure that the same propriety JVM is used for both client and server (i.e., Netscape or Hot Java browsers as clients and Sun JRE as a server, or, Microsoft Internet Explorer as a client and Wjview as a server).

Local Intranet Use

If the system uses a Web browser to access a local Intranet Web server, and there is a Proxy server installed for communication with the Internet, the Proxy server must be disabled when connecting to the Web server running ConfigMaster.

To disable the Proxy server:

1. Configure the Proxy server not to pass out the Web server IP address (after configuring, reboot the client before connecting the Web server).
2. Disable the Proxy client (WSP Client) in the Control Panel.
3. Configure the browser to bypass the Proxy server when connecting the Web server IP address.

To configure the Internet Proxy with a Web server ID:

1. Select **Start > Settings > Control Panel**. The **Control Panel** window opens.
2. Click **Internet Options**. The **Internet Options** window opens.
3. Click the **Connections** tab. The **Connections** tab opens.
4. Click **LAN Settings...**.
5. In the Proxy server panel, select the two checkboxes and click **Advanced** to open the **Proxy Settings** window.
6. In the Exceptions panel, enter the Web server IP address.
7. Click **OK**.
8. Click **OK** in the **Internet Options** window.

ConfigMaster.bat Does Not Activate ConfigMaster

If running ConfigMaster.bat does not activate ConfigMaster and displays an error message regarding an invalid path, check if the command interpreter is 32-bit (MS-DOS Prompt or Command Prompt).

This error occurs if a 16-bit command interpreter, which does not support long filenames, runs the batch file.

Running the BER/ASCII Converter Without Running ConfigMaster

The BER/ASCII converter can run using the following batch file:
/ <Installation_Directory>/ConfigMaster/NMS/ Configuration/convert.bat

The syntax is:

```
convert.bat <direction> <Source_file> <Destination_file>
```

Where:

<direction> - Indicates the type of the file conversion: enter **0** to convert an ASCII file to BER format; and **1** to convert a BER file to ASCII format.

<Source_file> - Indicates the name of the file being converted to another format.

<Destination_file> - Indicates the name of the file after conversion.

Starting ConfigMaster

To start the ConfigMaster application:

- ◆ Click  on the desktop.





or

- ◆ Select **Start > Programs > D-Link Corporation > ConfigMaster**. The **ConfigMaster Main** window opens:



Figure 6- 11. ConfigMaster main window

The **ConfigMaster Main** window displays the following information:

- ◆ **Device** – The user-defined names of frequently used devices, which appear in a drop-down list. The Device list can be added to and edited.
- ◆ **IP** – Indicates the device's IP address. IP addresses can be selected from the drop-list.
- ◆ **Community** – Displays a community name defined for the selected device.
- ◆ **Connect** – Click  to open the selected device front panel display.
- ◆ **Help** – Click  to access ConfigMaster's on-line Help.
- ◆ **Options** – Click  to set ConfigMaster options before starting the front panel display applet.
- ◆ **About** – Click  to see the date of the current software version.
- ◆ **Cascade Windows** – Click  to arrange all open windows in a cascade (except for the secondary windows such as Edit and Insert dialog boxes, confirmation messages, etc.).

- ◆ **Error Log** – Click **Error Log...** to display the ConfigMaster Error Log. The messages of this log are generally describe problems encountered while starting up the applet, for example, wrong IP addresses, unknown device names, unsuccessful calls to the server, etc.

Error Log

The Error Log contains information regarding errors that may have occurred while connecting to devices.

- ◆ To display the **Error Log** window, click **Error Log...**. The following **Error Log** window opens:



Figure 6- 12. Error Log window

There are three main connection errors:

- ◆ **Device Error** – Indicates that a connection was attempted to a non-existent device.
- ◆ **Unknown Device** – Indicates that a connection was attempted to a device that the system does not recognize.
- ◆ **Version Unknown** – Indicates that a connection was attempted with an obsolete version of the device.

Device Error

If a connection attempt is to a non-existing device, the following Device Error message is displayed prompting reconnection. The device IP address should be checked and re-entered.

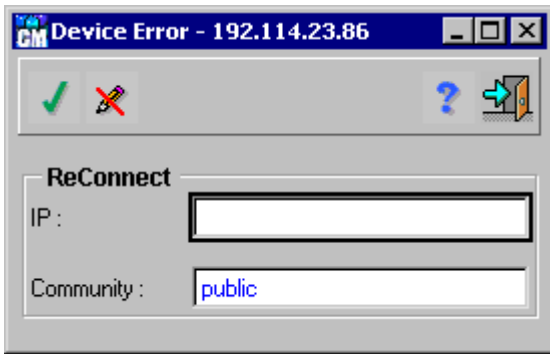





Figure 6- 13. Device Error window

To edit the IP address or Community:

- ◆ In the IP field, enter the correct IP address and click .

To re-enter the IP address or Community:

1. Click . The fields are cleared.
2. Re-enter the IP address and Community and click .

To return to the Main Window:

- ◆ Close the **Device Error** window.

Unknown Device

The **Unknown Device** window is displayed when a connection is attempted to a device not supported by the system.



Figure 6- 14. Unknown Device window

To re-enter the IP address:

1. Close the **Unknown Device** window. The **ConfigMaster Main** window opens.
2. Re-enter the IP address and click .

Version Unknown

The **Unknown Version** window is displayed when a connection is attempted to an obsolete version of the device.



Figure 6- 15. Unknown Version window

The following fields display:

- ◆ **Current Version** – Indicates the current version of ConfigMaster that is currently running.
- ◆ **Supported Versions** – Indicates the ConfigMaster versions supported
- ◆ **Device Name** – Identifies the user-defined device name.
- ◆ **IP** – Identifies the IP address.
- ◆ **Type** – Identifies the device type.

Using ConfigMaster Windows

ConfigMaster’s GUI is windows based with a standardized screen layout. The following figure illustrates a typical screen layout.

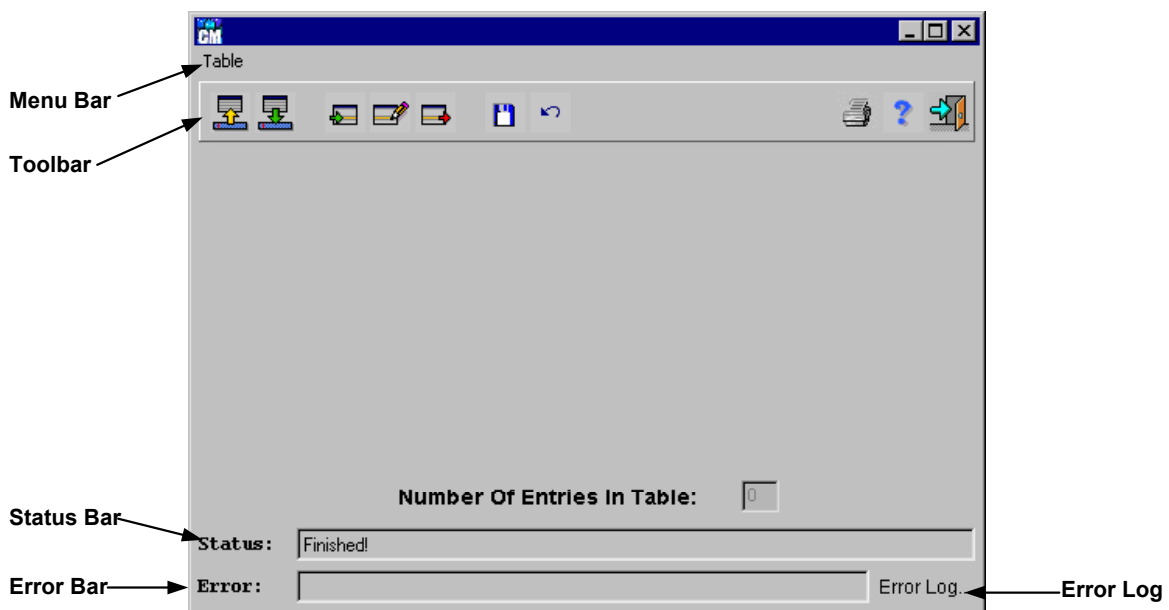

Figure 6- 16. Typical ConfigMaster window

The screen is divided into the following sections:

- ◆ Menu Bar.
- ◆ Toolbar.
- ◆ Error Log.
- ◆ Error Bar.
- ◆ Status Bar.

Menu Bar













Most windows opened directly from the front panel display contain a menu with various options. The most widely used options are:

- ◆ **Refresh** – Polls the device and shows new information.
- ◆ **Set** – Sends and updates new configurations to the device.
- ◆ **Insert** – Inserts a new row into a table.
- ◆ **Edit** – Allows information in a dialog box or table to be edited.
- ◆ **Delete** – Deletes information from a table.
- ◆ **Close** – Closes a dialog box or table.

Toolbar

ConfigMaster windows have toolbars for quick access to ConfigMaster options. Each window contains only those toolbar icons that are relevant to that window. The table below describes standard Toolbar icons used in the application.

ConfigMaster Toolbar Icons

Icon	Function	Relevant Shortcut
	Polls the device and show current information.	Ctrl+R
	Sends new data from a window to the device and update the device.	Ctrl+S
	Opens a dialog box for inserting a table row. Remember to click  to save modifications in the table.	Ctrl+L
	Opens a dialog box for editing table data. Remember to click  to save modifications in the table.	Ctrl+E
	Deletes the selected table rows.	Ctrl+D
	Prints the current screen.	Ctrl+P
	Generates a graph.	
	Opens a previously stored graph configuration.	
	Undoes all changes since the last time  was clicked.	
	Exits from the current screen and/or application	





Icon	Function	Relevant Shortcut
	Sends table modifications or additions made in an Insert or Edit dialog box to the table.	Ctrl+U
	Cancel changes in an Insert or Edit window.	
	Erases the data from the entire table.	
	Saves a trap to file in the Traps Table.	
	Accesses the Statistics window.	

Table 6- 1. ConfigMaster Toolbar Icons

Error Bar

Displays an explanation of an SNMP action that could not be carried out or that failed for any reason.

Status Bar

Indicates the last SNMP action status. The most common status bar messages are the following:

- ◆ **Sending Data** – Displayed when the device is reading or writing.
- ◆ **Data Arriving** – Displayed when the device is getting SNMP data.
- ◆ **Finished** – Displayed when a set or get action has been completed.
- ◆ **Sending Window Request!** – Displayed when the device is searching for a window or table.

Setting ConfigMaster Options

The NMS options can be set before starting the applet. The method of accessing the **General Options** window is as follows: On the main window, click the **Options** button (or click **Ctrl+O**).

The **General Options** window opens:

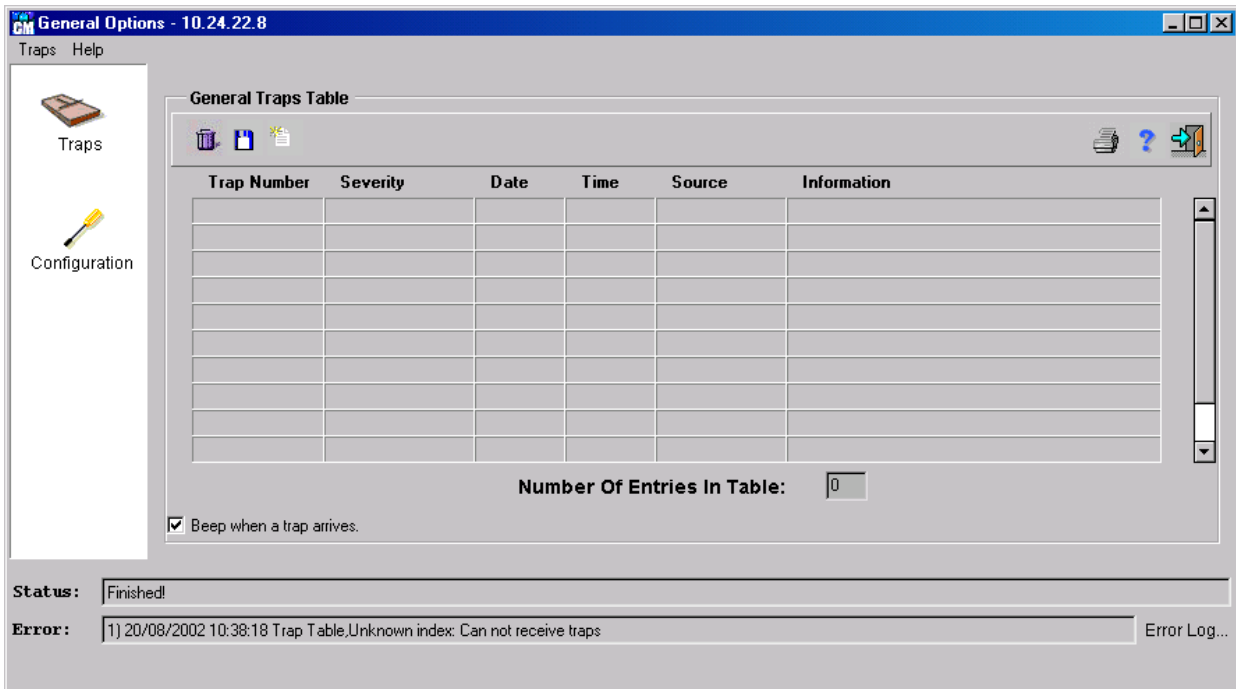



Figure 6- 17. General Options window

The **General Options** window is divided into two panes, the left pane contains the screen functions, and the right pane contains corresponding function screen. The left pane always remains constant. Clicking on the function icons in the left pane toggles the right pane. In the **General Options** window left-hand pane, the following two icons are displayed:

- 

The **General Options** window displays the **General Traps Table** by default. Tables displaying system signal traps.
- 

Displays the **General Options - Configuration** dialog box in the right pane. Used for modifying system configuration options.

Viewing the General Traps Table

With ConfigMaster, SNMP network events, or traps, can be viewed.

To view the General Traps Table:

- ◆ Click the  icon in the left pane.

The **General Traps Table** is displayed in the right pane:

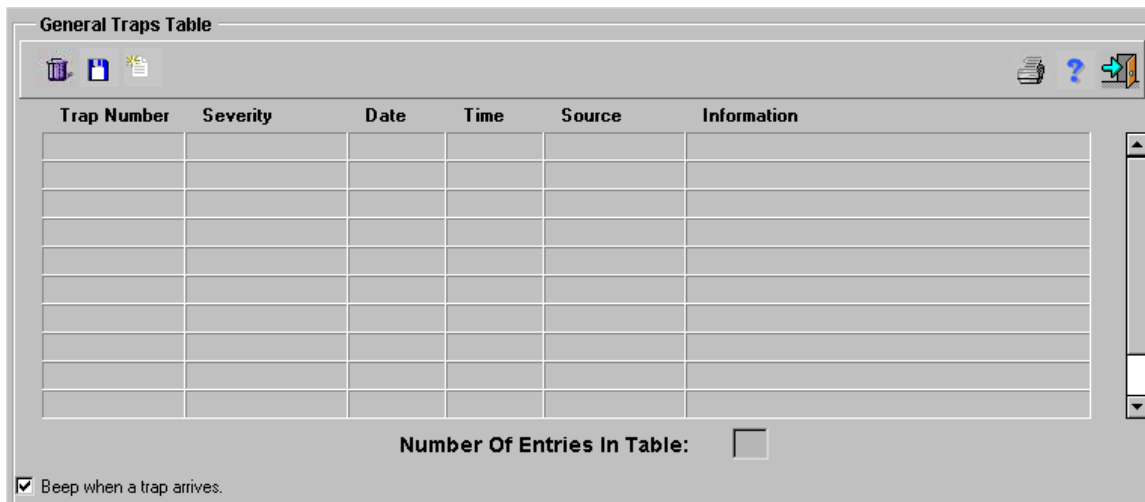

Figure 6- 18. General Traps Table

The **General Traps Table** displays the following information:

- ◆ **Trap Number** – A consecutive number given to each event to make information retrieval more efficient.
- ◆ **Severity** – The event level, which can be one of the following: *Informational*, *Warning*, *Error*, or *Fatal*.
- ◆ **Date and Time** – When the trap occurred.
- ◆ **Source** – The device IP address sending the trap.
- ◆ **Information** – An event description. For example, Link Up.



To view a device front panel display from the trap source:

- ◆ Double-click a trap in the **General Traps Table** to open the device front panel display that sent the trap.

To set an alarm when receiving traps:

- ◆ Click the “Beep when a trap arrived” checkbox to hear the beep every time a new trap arrives.

The **General Traps Table** has the following icons on the toolbar:

Icon	Function
	Delete General Traps Table entries.
	Save the General Traps Table . The Status bar displays the file path to which the trap has been saved: <ConfigMaster>/Nms/Configuration/traps.dat.

Configuring Trap Parameters

To configure the number of traps displayed in the General Traps Table and how many traps stored in a file:

- ◆ From the **General Options** window **Menu Bar** click  , then select **Traps Configuration**. The **Saved traps** window opens:

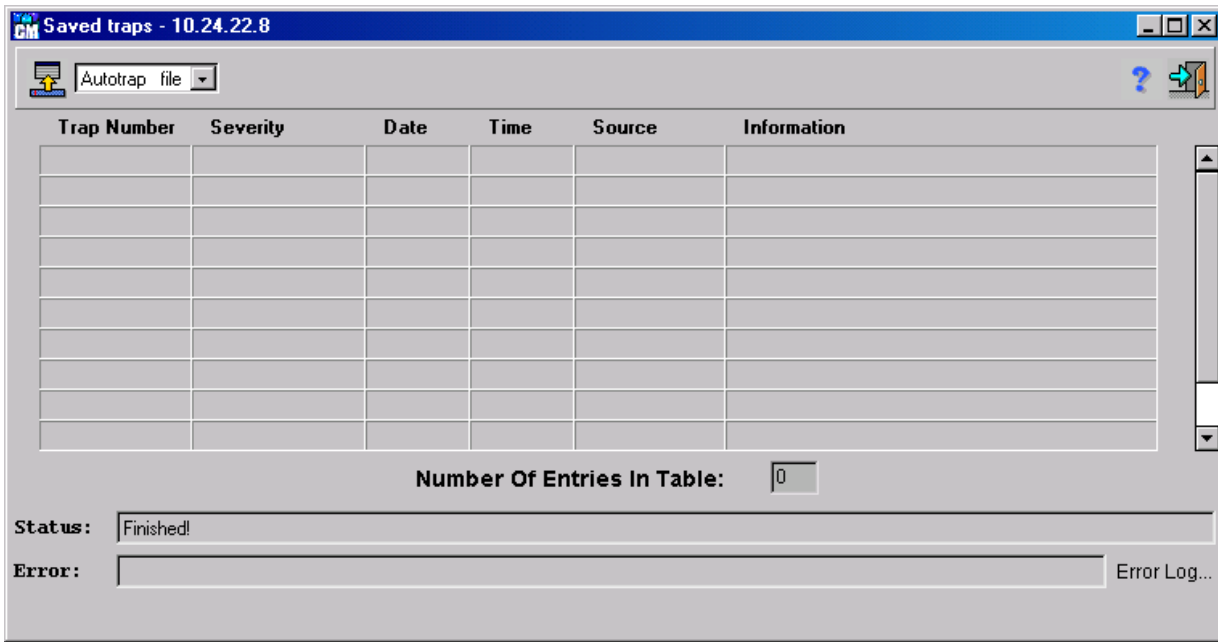



Figure 6- 19. Saved traps window

The following parameters are displayed in the **Saved traps** window:

- ◆ **Maximal number of traps to display** – How many traps are displayed in the **General Traps Table**. By default, 500 traps can be displayed.
- ◆ **Maximal number of traps to keep in file** – How many traps to store in a file. The default value is 5000, i.e. 5000 traps are stored by the system in the file called `autotraps.dat`.

The maximal number of traps to keep on file must be greater than the maximal number of traps to display. For example, with maximal number of traps to display set to 100 and maximal number of traps to keep in file set to 300. If 150 new traps arrive, the most recent 100 traps are displayed in the Traps Table and the rest of the new traps (50 traps arrived earlier than the 100 traps displayed in the Table) are stored in the `autotraps.dat` file.

Enter the two parameters and click . The configuration is saved and the **General Traps Table** opens.

General Options Configuration

In the left pane click  to display the **General Options - Configuration** window:

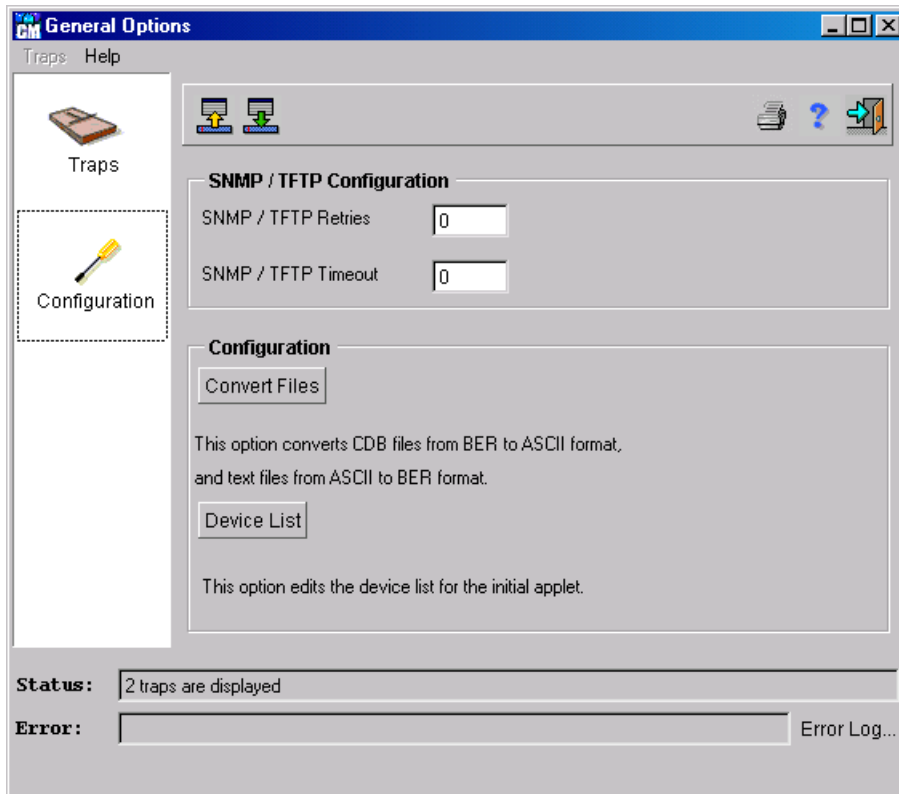

Figure 6- 20. General Options - Configuration window

There are two configuration options:

- ◆ SNMP/TFTP Configuration.
- ◆ Configuration.

SNMP/TFTP Configuration

In the SNMP/TFTP Configuration area of the **General Options - Configuration** window, configure the options for sending requests to accommodate for different traffic loads.

To configure the SNMP/TFTP:

1. In the SNMP/TFTP Retries field, enter the number of times that the device tries to reach the server.
2. In the SNMP/TFTP Timeout field, enter the number of seconds the device waits for a response from the server before the request is timed out. After every new try, the number of seconds is doubled.

For example, if 3 is entered in the SNMP/TFTP Retries field and 1 in the SNMP/TFTP Timeout field, the device sends a request and wait for one second. If there is no response from the server after one second, the device tries again, waiting for two seconds. The third try lasts up to four seconds.

This doubling technique provides servers with more opportunities to respond to requests. ConfigMaster systems operating in traffic-heavy networks waits longer before timing out requests (i.e., make the SNMP/TFTP Timeout value large).

To reset the fields to the stored configuration on the system, click .

- ◆ Click . The options are entered into the system.

Configuration

The **General Options** widow allows for files conversions and editing both file and device configuration, and includes the following options:

- ◆ Converting Files.
- ◆ Editing the Device List.

Converting Files

Edit the Configuration File:

1. In the **General Options - Configuration** window, click **Convert Files** to translate the configuration file from BER format to ASCII format.
2. Edit the configuration file and then translate the file from ASCII format to BER format. The **Configuration File – Conversion** window opens:

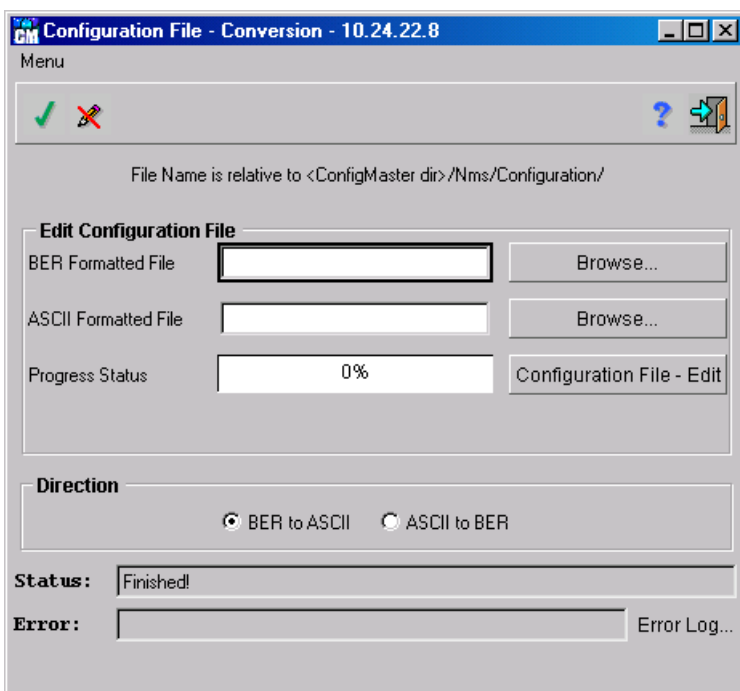

Figure 6- 21. Configuration File – Conversion window

3. Enter the BER formatted file and target ASCII formatted file in the fields provided.
4. Select the conversion direction *BER to ASCII* and click **Edit ASCII File**. The file is converted from BER to ASCII format.
5. Edit the ASCII file.
6. Select the conversion direction *BER to ASCII* and click **Edit ASCII File**. The file is converted back to BER format.

Note: *The Edit Configuration File option can be also accessed via the front panel display Menu Bar command **File > Configuration File > Edit Configuration File**.*

In addition to editing the Device List, the Device List can be used for:

- Adding New entry to Device List – Adds new devices to the device list.
- Making a Device the Default – Provides information for defining a device as the default device on the device list.

◆ Modifying a Device – Provides information for modifying the device list.

Deleting a Device – Provides information for deleting a device from the device list.

Editing the Device List

Adding user-defined device names as default to the **ConfigMaster Main** window Device list, allows the display of a device front panel display by selecting its name from the Device list (without entering its IP address), and clicking **Enter**. In the **General Options - Configuration** window, click **Edit Device List** to manage the device list. The following **Edit the Device List** window opens:

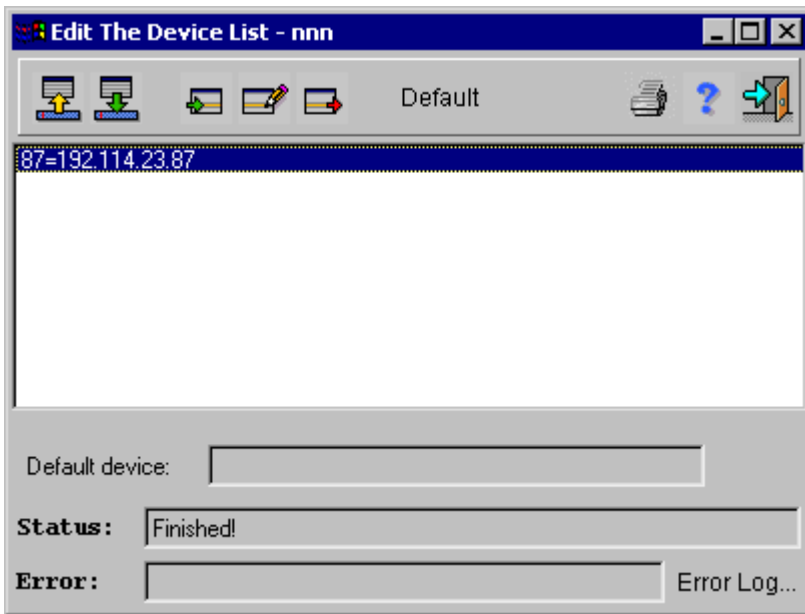



Figure 6- 22. Edit the Device List window

Adding New entry to Device List

To add a new entry to the Device list:

1. Click . The **Insert a Device** dialog box opens:

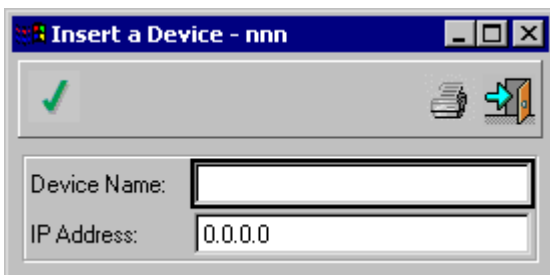



Figure 6- 23. Insert a Device dialog box

2. Enter new device name and the IP address in the **Insert a Device** dialog box.
3. Click . In the **Edit Device List** window, the new device name appears.

Making a Device the Default

A default device can be defined.



To make a device the default:

1. Double-click a device name, or select a device name and click **Default**.
2. Click . The selected device is set as the default device.

Modify a Device

The devices on the device list can be modified.

To Modify a device:

1. Select the device.
2. Click  to modify the names already configured for the network devices.
3. Click . The selected device is modified.

Deleting a Device

Devices can be deleted from the device list.

To delete device:

1. Select the device.
2. Click . The device is removed from the list.

The Front Panel Display

The front panel display GUI is a graphic image illustrating the device combined with the user interface. Labels in the front panel display represent the various interfaces of units and are color-coded for easy identification. All ConfigMaster options are accessed through the front panel display. It provides a device zoomed image. The front panel display has access to all options for controlling the device.

Opening the Front Panel Display

To open the front panel display:

1. From the **ConfigMaster Main** window, enter the device IP Address in the IP field, or select the device name in the device field.
2. Click the  button. The selected device front panel display opens.

Note: *If a device error, unknown device or version unknown error occurs when attempting to start the applet, an error message is displayed requesting reconnection. For further information, refer to Error Log.*

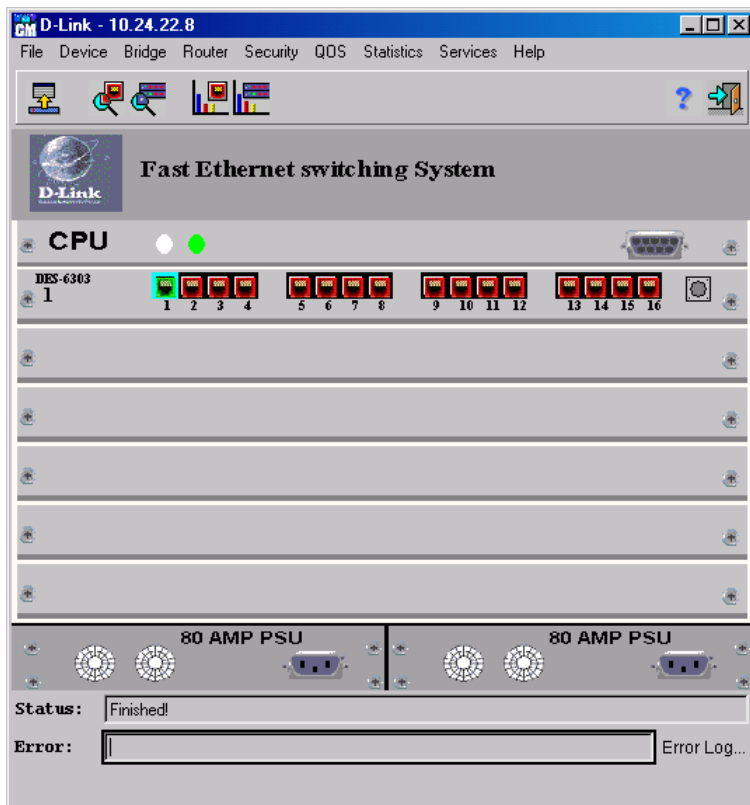

Figure 6- 24. Front Panel Display

Front Panel Display Toolbar

The front panel display toolbar includes the following icons:

Front Panel Display Toolbar Icons

Icon	Function	Relevant Shortcuts
	Refreshes the front panel display	Ctrl+R
	Accesses the Port Properties window	Ctrl+T
	Accesses the Global Parameters window	Ctrl+G
	Views Port Statistics for the selected port	Ctrl+P
	Views Element Statistics	
	Accesses the on-line Help	F1
	Exits the front panel display	Ctrl+X

Table 6-1. Front Panel Display Toolbar Icons

Understanding Front Panel Display Colors

Around each port on the front panel display is a colored border. These borders indicate the device port status. The following table describes the various status indications.

Front Panel Display Interface Color-Code

Label Color	Explanation
Green	Interface link is up
Red	Interface link is down
Blue	Port selected

Table 6-2. Front Panel Display Interface Color-Code

Understanding the Front Panel Display LEDs

The front panel displays LEDs as they appear on the device front panel. The LEDs are color-coded with the same configuration as the front panel.

Each card has its own set of LEDs. The LEDs on the host card indicate the device LED indication mode. The LEDs on the other cards indicate the card individual port status.

Front Panel Display Mode LEDs

On the Host card are eight mode LEDs. Each LED represents a device function mode. The mode selection determines what function is indicated by the LEDs on the individual cards. The selection is made by physically clicking the Mode Selector button. The mode selected is applied to all the LEDs on the device, for example, if "Rx" is selected, wherever a port is receiving a signal, the port corresponding LED indicates this status.

Device Front Panel Display Power LEDs

On the Host front panel there are two power supply LEDs. The LED indicates the device power supply status.

The top LED indicates if the device is powered by the power supply 1. The bottom LED indicates that the unit is power by the power supply 2. The following table describes the color code representing the power supply status.

Color Codes for Power Supply LEDs

Color	Status
LED on	The power is being supply.
LED off	A fault has been detected in the power supply.

Table 6-3. Color Codes for Power Supply LEDs

Front Panel Display Card LEDs

On all cards installed, there is a corresponding LED for each configured port. Based on the mode selected on the host panel, the LED indicates the port status.

Color Codes for the Status LED

Function	Indication and Status	Giga Indications and Status
Link/act	LED On—Link is up LED On and blinking—Link is up	LED On—Link is up LED On and blinking—Link is up

	and active LED Off—Link is down	and active LED Off—Link is down
10/100	LED On—100Tx LED Off—10BaseT	LED On—1000 Mbps
Coll	LED On—Collision occurs	N/A
B.P. (Back Clickure)	LED On—Receive buffer threshold number is exceeded	N/A
Act	LED On—Activity in the link	LED On—Activity in the link
FD (Full Duplex)	LED On—Full Duplex LED Off—Half Duplex	LED On—Full Duplex LED Off—Half Duplex
Tx	LED On—Link is transmitting traffic	LED On—Link is transmitting traffic
Rx	LED On—Link is receiving traffic	LED On—Link is receiving traffic

Table 6-4. Color Codes for the Status LED

View Port Status

To view a specific port status:

1. Click a port to select it. Selected ports are highlighted in blue.
2. Right-click a port to open a context-sensitive menu. There are two menu selections:
 - ◆ Refresh Port – The port status is refreshed
 - ◆ Port Properties – Displays the port configuration
3. Double-click a port.
 - or
 - Click **Ctrl+T**
 - or
 - Click the  to open the **Port Properties** window for other configuration options.
4. Select a port and click **Ctrl+P** to open the **Port Statistics** window for other configuration options.

Refreshing the Front Panel Display

To view the current device and interface status, the front panel display can be refreshed.

To refresh the front panel display:

1. Click **Ctrl+R**
 - or
 - Click .
 - or
 - Select **Services > Refresh Device Version**. The **Check Version** for window opens:

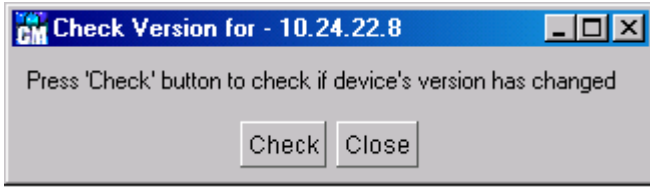

Figure 6- 25. Check Version for window

2. Click **Check**. The device is polled for current device and its interfaces.

ConfigMaster Shortcuts

ConfigMaster has a set of shortcuts for quick access to the main ConfigMaster options. The following table describes the shortcuts and functions used in the ConfigMaster screens.

Note: The plus sign (+) is used in the table to show that two keys should be clicked simultaneously, or two actions should be performed at the same time

ConfigMaster Shortcuts

Shortcut	Function
ConfigMaster Main Window	
F1	Accesses the on-line help.
Ctrl + O	Accesses the General Options - Traps Table .
Enter	Opens the selected device front panel display.
Ctrl + right click inside the IP field; Or Ctrl + D	Accesses the Edit Device List window.
Front panel display	
F1	Accesses the on-line help.
Ctrl + X	Exits the front panel display.
Ctrl + R	Refreshes the front panel display.
Ctrl + G	Accesses the Global Parameters window
Ctrl + T; Or double click the port	Accesses the Port Properties window
Select a port and click Ctrl + P	Accesses the Port Statistics window.
Windows	
Ctrl + S	Sends the data from the window to the device.
Ctrl + R	Refreshes the front panel display showing the current device and its interfaces status.
Ctrl + L; Or double click an empty row	Accesses the Insert dialog box.
Ctrl + D	Deletes a table row.

Shortcut	Function
Ctrl + E; Or double click the row to edit	Accesses the Edit Dialog box
Ctrl + X	Exits the window.
Right click the table row and choose Undo	Undoes the last action performed in the selected table row.
F1	Accesses the on-line help.
Insert/Edit Dialog Boxes	
Ctrl + U	Sends the table modifications made in the Insert/Edit dialog box to the table.
Escape	Closes the dialog box and return to the table
Tables	
Drag the mouse across the table rows	Selects multiple table rows Note: This option is not available for FACS, VLAN and Global Forwarding tables.
Edit Device List Window	
Double click the device name within the table row	Sets the device name as default
Enter (in the Insert a Device dialog box)	Adds a new device name to the Device list in the Edit Device List window (This shortcut is used instead of clicking  .)
Traps Table	
Double click the trap within the table row	Opens the Device front panel display that sent the trap

Table 7-5. ConfigMaster Shortcuts

Using Tables

Within ConfigMaster there are tables for configuring devices. The tables are opened though the various operational screens. Section includes the following:

- ◆ Editing Table Rows.
- ◆ Inserting Table Rows.
- ◆ Deleting Table Rows.
- ◆ Erasing Tables.

Editing Table Rows

Certain ConfigMaster tables allow editing. If editing is not allowed, the  toolbar icon does not appear.

To edit an existing table row:

1. Select the table row

2. Click .

or

Double-click the selected row.

or

Click **Ctrl+E**.

The **Edit** dialog box opens.



3. Edit the parameters. Parameters that cannot be edited will not appear or are disabled.

Note: To cancel changes, click .

4. Click .

or

Click **Ctrl+U**. The **Edit** dialog box closes and the row appears yellow in the table.

Note: To undo changes, click . This option affects only those changes that have been made since  was clicked.

◆ To upload the modifications to the device, click .

Inserting Table Rows

Certain ConfigMaster tables allow new rows. If adding a row is not allowed, the  toolbar icon does not appear.

To add a new table row:

1. Click .

or

Double-click an empty row in the table.

or

Click **Ctrl+L**. The **Insert** dialog box opens.



2. Enter the parameter values. Parameters that are set automatically do not appear.

Note: To cancel changes, click .

3. Click .

or

Click **Ctrl+U**. The **Insert** dialog box closes and the row appears yellow in the table.

Note: To undo changes, click . This option affects only those changes that have been made since  was clicked.



◆ To send the changes from the table to the device, click .

Deleting Table Rows

Certain ConfigMaster tables allow row deletion. If deleting a row is not allowed, the  toolbar icon does not appear.

To delete a table row:

1. Select a table row. To select multiple rows, drag the mouse across the table rows. This option is not available for FACS, VLAN and Global Forwarding tables.
2. Click 
or
Click **Ctrl+D**. The row is deleted.

Note: To undo changes, click . This option affects only those changes that have been made since  was clicked.

3. To send the changes from the table to the device, click .

Erasing Tables

Certain ConfigMaster tables allow the entire table to be erased. If a table cannot be erased  does not appear.

To erase an entire table:

- ◆ Click . All table rows are erased.

Working With Configuration Files

For security reasons, the configuration files are saved on the ConfigMaster computer in the following directory: ConfigMaster/Nms/Configuration.

To save (or backup) the configuration files in this directory:

- ◆ File access must be permitted. Files are sent by either FTP or copied into the configuration file directory.
- ◆ The configuration file is managed through the front panel display **File** menu. The **Configuration File** menu has the following menu options:
 - ◆ **Send Configuration To Device.**
 - ◆ **Get Configuration From Device.**
 - ◆ **Configuration File - Conversion.**

Send Configuration To Device

To download the configuration file backup copy to the device:

1. Select **File > Configuration File > Send Configuration to Device**. The **Send Configuration to Device** window opens:

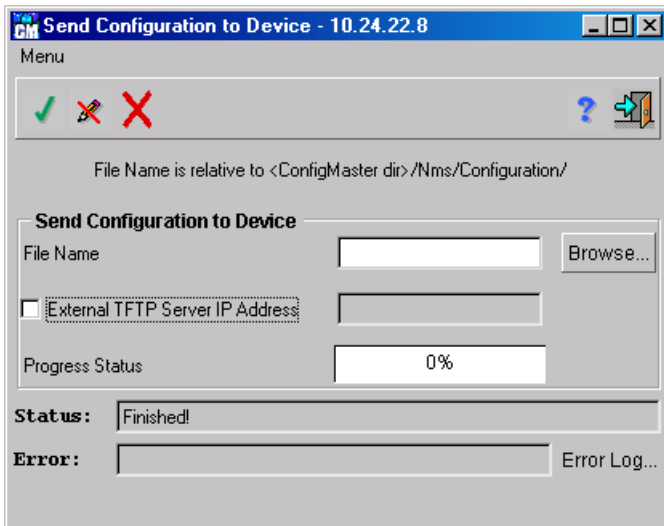



Figure 6- 26. Send Configuration to Device window

2. In the File Name field, enter the configuration file name to send to the device, or press **Browse...** to locate the configuration file name.
3. If the configuration file is saved on the external TFTP server, check the “External TFTP Server IP Address” check box and enter the external TFTP server IP address.
4. Click . The procedure begins. The procedure progress is illustrated by the Progress Status incremental bar. When the incremental bar indicates that the procedure is completed, a **Reset** window prompt opens.
5. Click **Reset** to reset the device. The device is reset.

Get Configuration From Device

To maintain a copy of the device configuration file, the device configuration is saved on the server.

To save (or backup) the modified configuration files:

1. Select **File > Configuration File > Get Configuration from Device**. The **Get Configuration from Device** window opens:

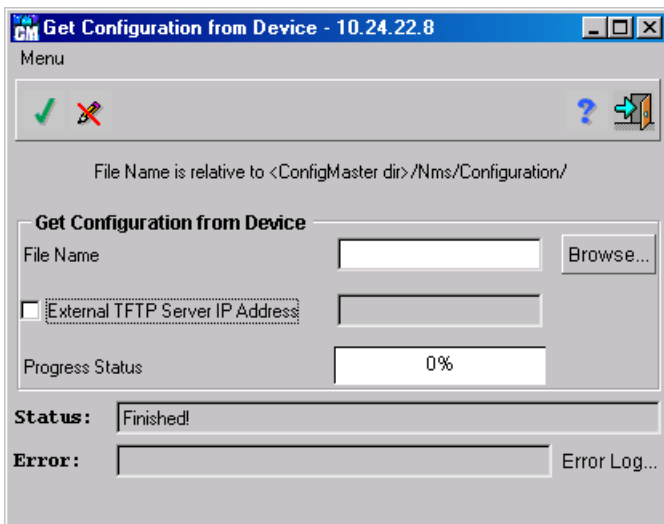

Figure 6- 27. Get Configuration from Device window

2. In the File Name field, enter the device configuration file, or click to locate the device configuration file name.
3. If the default TFTP server provided with the device is not required, check the “External TFTP Server IP Address” checkbox and enter the external TFTP server IP address. To use the default TFTP server, clear the “External TFTP Server IP Address” checkbox.
4. Click . The file saving procedure begins. The configuration file is retrieved from the server. The procedure progress is illustrated by the Progress Status incremental bar. When the incremental bar indicates that the procedure is completed, the file is retrieved.

Configuration File - Conversion

The **Configuration File - Conversion** screen is used to translate the configuration file from BER to ASCII format, edit the configuration file and then translate the file back from ASCII to BER format.

Note: Using the **Configuration File - Edit** button on the **Configuration File - Conversion** window to edit the configuration file in ASCII should be done only by authorized personnel familiar with the format, otherwise the procedure may result in configuration download errors.

Update Device Software

D-Link Corporation may release updated software versions of the device software. Software files reside on the web server computer and are downloaded from the ConfigMaster\Nms\Configuration directory.

Note: If download is not successful, the current device software version does not change. If download is successful, new software is not implemented until the device is reset.

To update the configuration device software:

1. Select **File > Update Device Software**. The **Update Device Software** window opens:

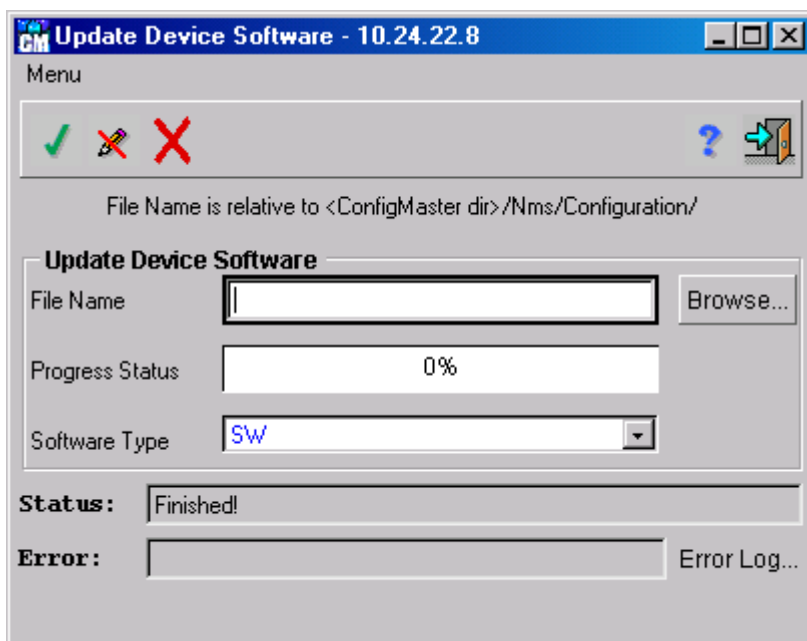

Figure 6- 28. Update Device Software window

2. In the File Name field, enter the Web server directory software file

or

Click **Browse...** to manually locate the software file.

3. Select one of the following software types for updating:

- ◆ SW.
- ◆ Features.
- ◆ CLI.

4. Click . The update procedure begins. The update progress is illustrated by the Progress Status incremental bar. The software update takes a few minutes. When the update is complete, the following **Confirm reset** window opens:



Figure 6- 29. Confirm reset window

5. Click **Reset** to reset the device. The **Resetting** window opens:

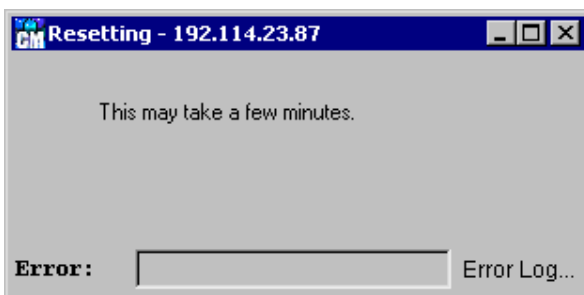

Figure 6- 30. Resetting window

The device is reset and the following **Reset complete** window prompt opens:



Figure 6- 31. Reset complete window

6. Click **O.K.**

Exit

To end the current front panel display session:

- ◆ Select **File > Exit**. The front panel display is closed and the **ConfigMaster Main** window opens.

Managing the Device

Reset Device implements changes made to the device.

To reset a device:

1. Select **Device > Reset Device**. The **Confirm Reset** window opens:

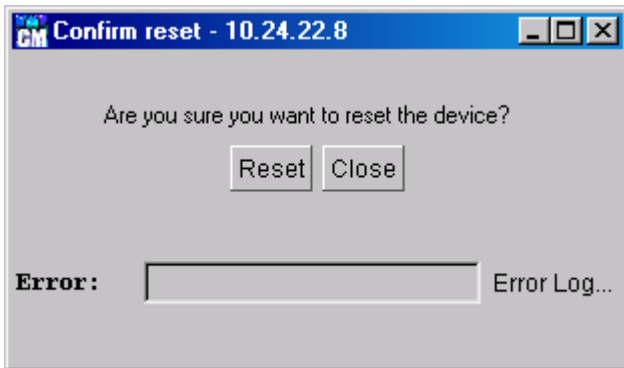

Figure 6- 32. Confirm reset window

2. Click **Reset** to reset the device. The **Resetting** window opens:

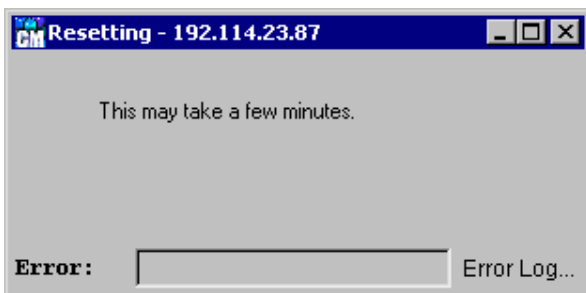

Figure 6- 33. Resetting window

The device is reset and the following **Reset complete** window opens:



Figure 6- 34. Reset complete window

3. Click **O.K.**

Device Global Parameters

The Global Parameters command is to set the device System Identification, Time and Software Version commands.

Note: The **Global Parameters** window can be also accessed by clicking  on the front panel display toolbar, or pressing **Ctrl+G**.

To display the Global Parameters screen:

- ◆ Select **Device > Global Parameters**. The **Global Parameters** window opens. The **Global Parameters** window has the following three tabs:
 - ◆ **Identification** – Defines a general description, user-defined name, location, and contact person for a device.
 - ◆ **Time** – Defines the System Up Time, System Time, and System Date for a device.
 - ◆ **Version** – Defines the software and hardware software versions running on a device.

The default screen is the **Identification** tab. The following figure illustrates the **Global Parameters** window **Identification** tab:

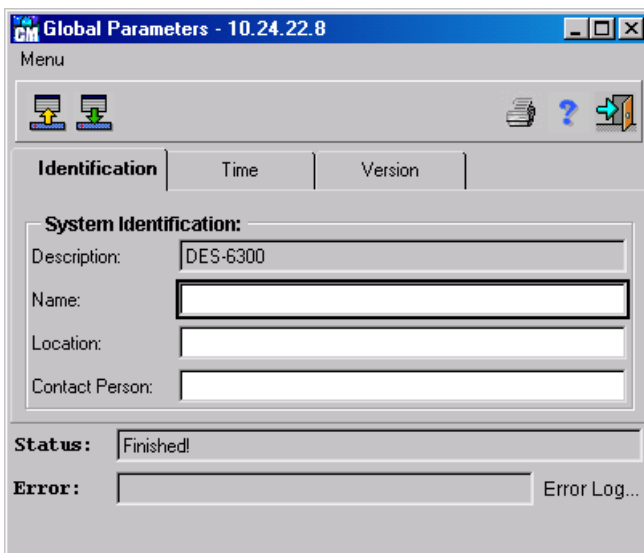



Figure 6- 35. Global Parameters – Identification tab

The **Identification** tab displays the following fields:

- ◆ **Description** – Device General description.
- ◆ **Name** – User assigned device name that appears on all system windows Title Bars.
- ◆ **Location** – Device geographic location.
- ◆ **Contact Person** – The persons responsible for the device.

To edit an Identification tab field:

1. Edit any field except the Description field.
2. Click . When the Status field displays “Finished!”, the fields are confirmed as modified.

The following figure illustrates the **Global Parameters** window **Time** tab:

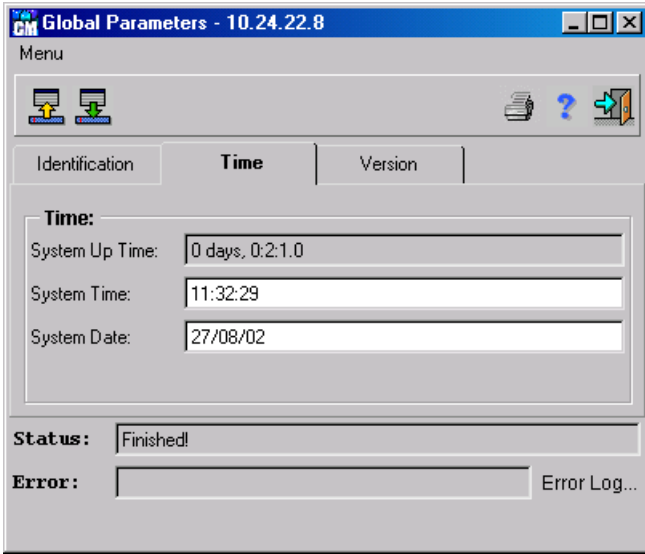



Figure 6- 36. Global Parameters – Time tab

The **Time** tab displays the following fields:

- ◆ **System Up Time** – Time elapsed since the last reset.
- ◆ **System Time** – Current user-defined device time (HH.MM.SS).
- ◆ **System Date** – Current user-defined device date (DD.MM.YY).

To edit a Time tab field:

1. Edit the System Time or System Date field, conforming to the date format as described above. The System up Time field cannot be modified.
2. Click . When the Status field displays “Finished!”, the fields are confirmed as modified.

The following figure illustrates the **Global Parameters** window **Version** tab:

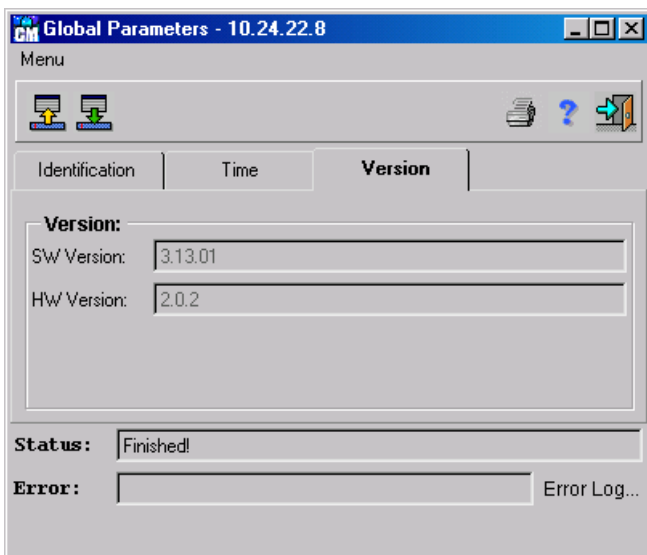

Figure 6- 37. Global Parameters – Version tab

The **Version** tab displays the following fields:

- ◆ **SW Software Version** – Software version currently running on the device.
- ◆ **HW Software Version** – Hardware Software version currently operating with the device.

Device Features

The **Device Features** window is a read-only window. It displays a list of features supported by the device's software version.

To display the Device Features screen:

- ◆ Select **Device > Device Features**. The **Device Features** window opens:

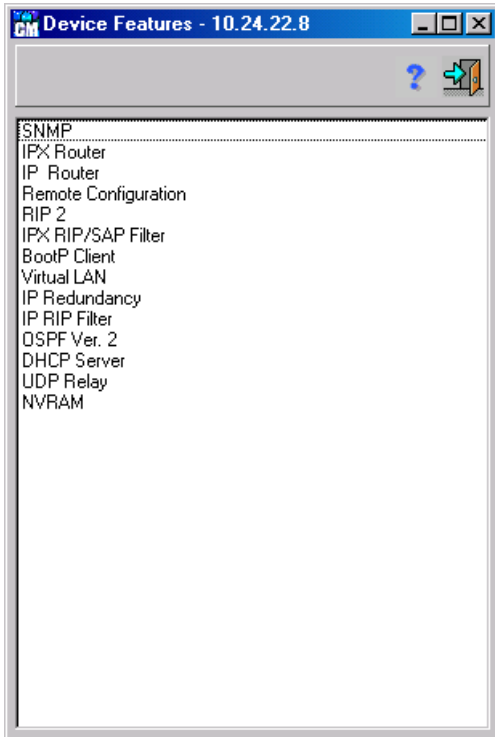

Figure 6- 38. Device Features window

Configuring VLANs

VLANs are logical subgroups with a Local Area Network (LAN) created via software rather than defining a hardware solution. VLANs combine user stations and network devices into a single unit regardless of the physical LAN segment to which they are attached. VLANs allow network traffic to flow more efficiently within subgroups. VLANs managed through software reduce the amount of time network changes, additions, and moves are implemented.

VLANs have no minimum number of ports, and can be created per unit, per device, per stack, or any other logical connection combination, as VLANs are software based and not defined by physical attributes.

VLANs function at a layer 2. Since VLANs isolate traffic within the VLAN, a layer 3 router working a protocol level is needed to allow traffic flow between VLANs. Layer 3 routers identify segments and coordinate with VLANs. VLANs are broadcast and multicast domain. Broadcast and multicast traffic is transmitted only in the VLAN in which the traffic is generated. The default VLANs are:

- ◆ IP VLAN.
- ◆ IPX Raw VLAN.
- ◆ IPX ET (ETH II) VLAN.
- ◆ IPX LLC VLAN.

- ◆ IPX SNAP VLAN.

Note: IP and IPX VLANs are automatically assigned a MAC address.

- ◆ SNA, AppleTalk, NetBios.
- ◆ Other VLANs – The "Other" VLAN is a "super-VLAN" that includes all protocols for which VLANs have not been defined. However, super-VLAN does not include IP or IPX. "Other" can be used to quickly configure the device as a full bridge.

The VLAN menu has the following menu options:

- ◆ VLAN Parameters.
- ◆ VLAN Table Per Port
or
- ◆ VLAN Table Per Port and Protocol.

ConfigMaster supports and automatically recognizes if the device is running VLAN per port or VLAN per port and protocol.

Working With VLANs

This section provides an explanation for configuring and working with VLANs, and provides the following sections:

- ◆ VLAN Parameters.
- ◆ VLAN Table Per Port
- ◆ VLAN Table Per Port and Protocol.

VLAN Parameters

To display the device VLAN Parameters window:

- ◆ Select **Device > VLAN Parameters**. The **Virtual LAN Parameters** window opens:

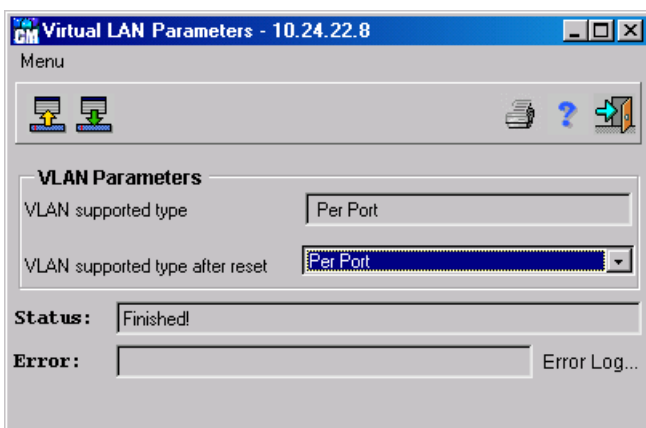

Figure 6- 39. Virtual LAN Parameters window

The following VLAN parameters are displayed:

- ◆ **VLAN Supported Type** – Indicates the type of VLAN currently supported.
- ◆ **VLAN Supported Type After Reset** – Indicates the type of VLAN supported after the device is reset. The possible values are:

- ◇ Per Port – Indicates the type of VLAN supported after the device is reset is per port based.
- ◇ Per Protocol and Port – Indicates the type of VLAN supported after the device is reset is per protocol and per protocol based.

To edit the VLAN Parameters:

- ◆ Click . When the Status field displays “Finished!”, the fields are confirmed as modified.

VLAN Table Per Port

The following window describes VLAN Table per port:

To display the VLAN Table window:

(Make sure *Per Port* is selected under “VLAN supported type after reset” on the **Virtual LAN Parameters** window (**Device > VLAN > VLAN Parameters**)).

- ◆ Select **Device > VLAN > VLAN Table**. The **VLAN Table** opens:

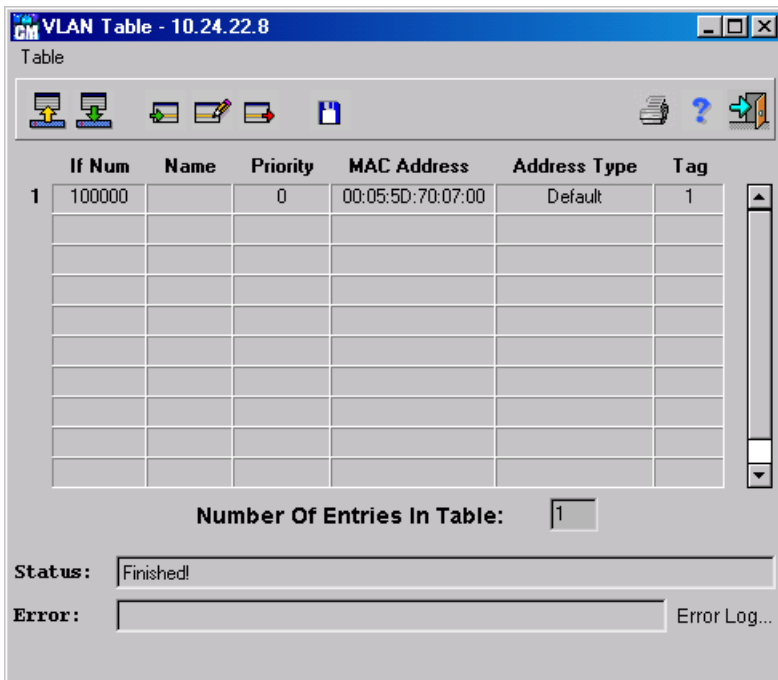

Figure 6-40. VLAN Table

The **VLAN Table** displays the following fields:

- ◆ **IF Num** – Identifies the VLAN interface number, automatically assigned by the management station.
- ◆ **Name** – Identifies the user-defined name of the VLAN.
- ◆ **Priority** – Specifies the priority of the VLAN. The possible values are:
- ◆ **MAC Address** – Permanent VLAN MAC address, automatically assigned by the device. This parameter applies to IP and IPX VLANs only, and is dependent on the VLAN address type.
- ◆ **VLAN Address Type** – If default the VLAN gets the device MAC address. If reserved the VLAN is assigned a unique MAC address based on the order of which it was configured (0-4096 reserved MAC addresses). The address types to select from are as follows:
 - ◇ Default – The default address.
 - ◇ Reserve – User-defined address.

- ◆ **Tag** – VLAN Tag ID. The possible values are 0-7.

To add new VLANs:

1. Display the **VLAN Table**.
2. In the **VLAN Table**, click . The **VLAN Table Insert** window opens:

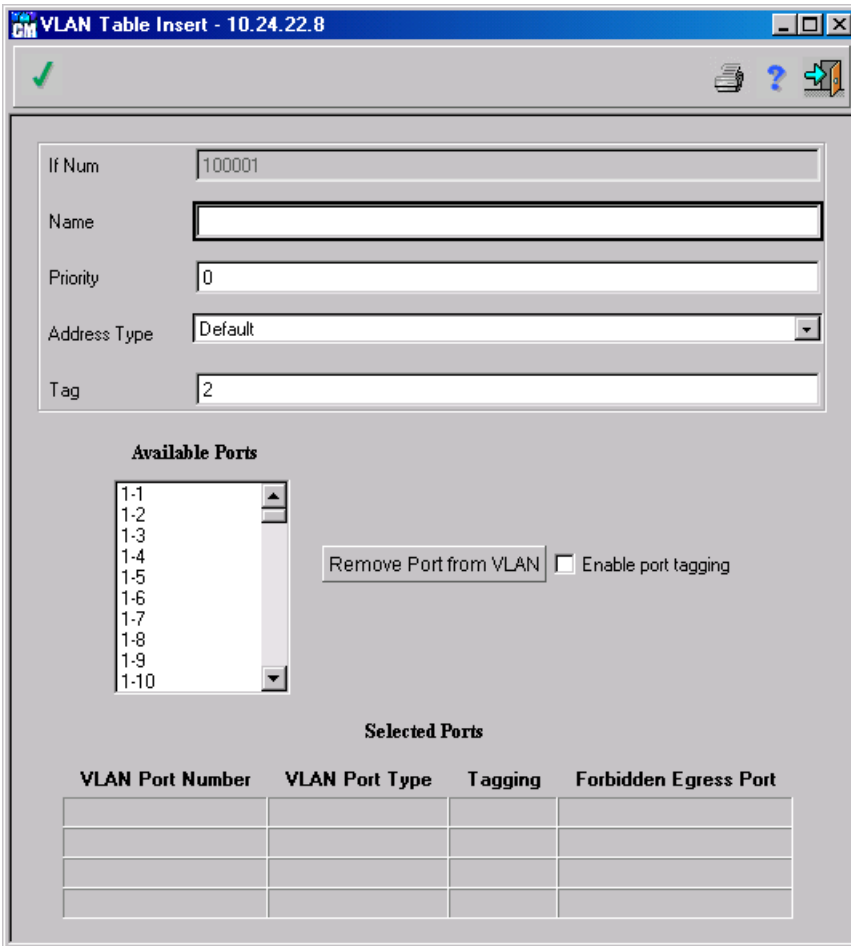

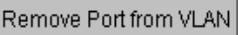



Figure 6-41. VLAN Table Insert window

3. Complete the fields.
4. Select a device port from the list displayed above the **Selected Port Table**. The selected port is added to the table where the following parameters are displayed:
 - ◆ **VLAN Port Number** – The selected port interface number.
 - ◆ **VLAN Port Type** – Either static or dynamic.
 - ◆ **Tagging** – Identifies the VLAN to which the frame belongs. To enable port tagging check the Enable port tagging checkbox.
 - ◆ **Forbidden Egress Ports** – Indicates ports that are forbidden to be included in the Egress Ports List for this VLAN.
5. Click  to apply the new data.
6. Close the **VLAN Table Insert** window.



To delete ports from the Port Table:

1. Display the **VLAN Table** window.
2. In the **VLAN Table** window, click . The **VLAN Table Insert** window opens.
3. Highlight the port numbers of the ports you want to delete in the Port Table.
4. Click . The ports are highlighted and the port numbers appear in the Available Ports list.

To edit Existing VLANs:

1. Display the **VLAN Table**.
2. Select an entry in the table.
3. Click . The **VLAN Table Edit** window opens. The window is identical to the **VLAN Table Insert** window.
4. Edit the required fields.
5. Click  to apply the new data.
6. Close the **VLAN Table Edit** window.

To delete Existing VLANs:

1. Display the **VLAN Table**.
2. Select an entry in the table.
3. Click . The entry is deleted.
4. Click  to update the device

VLAN Table Per Port and Protocol

To display the VLAN Table window:

(Make sure *Per Protocol and Port* is selected under “VLAN supported type after reset” on the **Virtual LAN Parameters** window (**Device > VLAN > VLAN Parameters**)).

- ◆ Select **Device > VLAN > VLAN Table**. The **VLAN Table** opens:

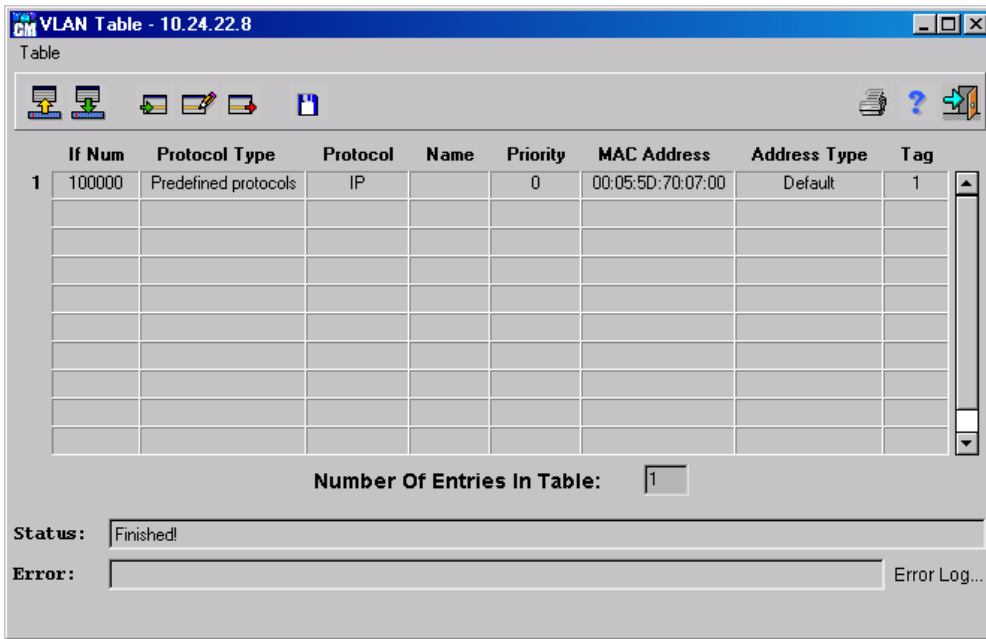



Figure 6- 42. VLAN Table window

The **VLAN Table** window displays the following fields:

- ◆ **IF Num** – The VLAN interface number, automatically assigned by the management station.
- ◆ **Protocol Type** – Indicates the type of protocol used. The possible value is Predefined Protocol. The type of predefined protocol used is defined in the Protocol field.
- ◆ **Protocol** – Specifies the VLAN protocol type. The possible values are:
 - ◇ IP
 - ◇ IPX Raw
 - ◇ IPX ET
 - ◇ IPX LLC
 - ◇ IPX SNAP
 - ◇ Dec Net
 - ◇ Net Bios
 - ◇ SNA
 - ◇ Other
- ◆ **Name** – Indicates the user-defined VLAN name.
- ◆ **Priority** – Indicates the value of the priority tag. The possible value is 0-7.
- ◆ **MAC Address** – Permanent VLAN MAC address, automatically assigned by the device. This parameter applies to IP and IPX VLANs only, and is dependent on the VLAN address type.
- ◆ **Address Type** – Indicates the MAC address type being used. The possible values are:
 - ◇ Default – The VLAN receives the device MAC address.
 - ◇ Reserved – The VLAN is assigned a unique MAC address based on the order of which it was configured (0-4096 reserved MAC addresses).
- ◆ **Tag** – Indicates if the VLAN tag is used to identify to which VLAN a packet belongs.

To add new VLANs for VLANs per Port and Protocol:

1. Display the **VLAN Table** window.
2. In the **VLAN Table** window, click . The **VLAN Table Insert** window opens:

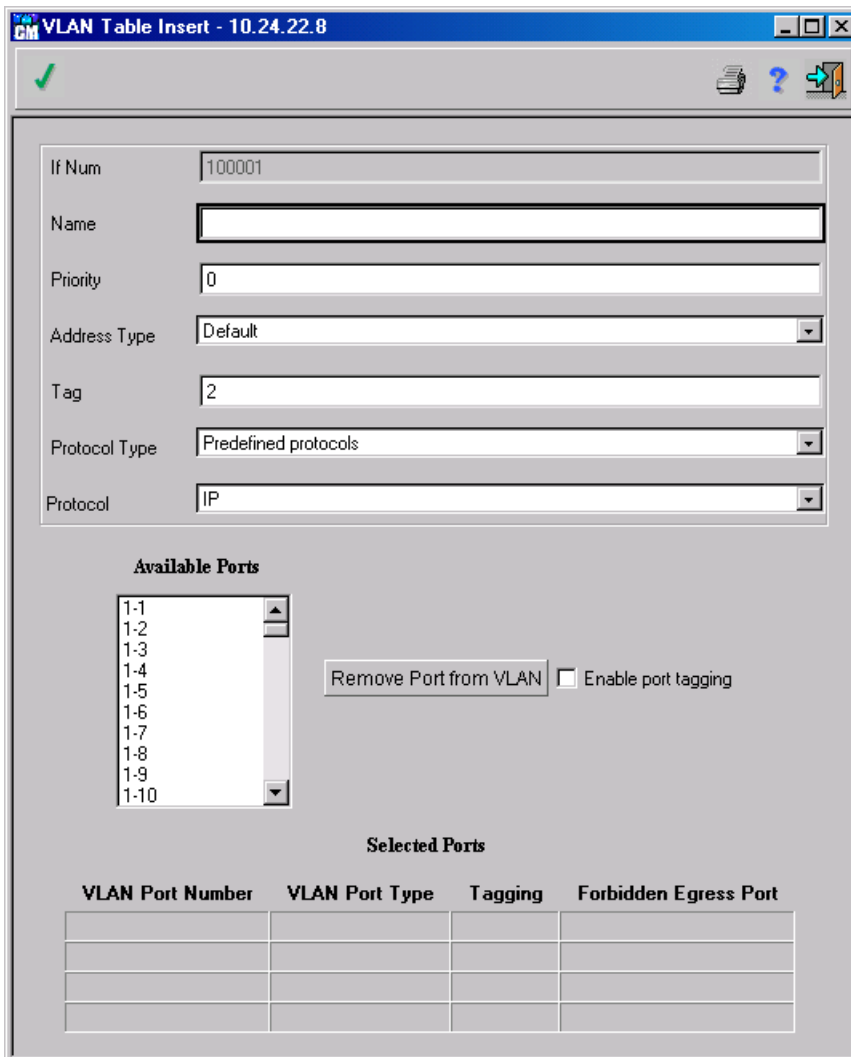

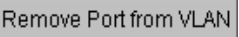



Figure 6- 43. VLAN Table Insert window

3. Complete the fields. The fields are the same as the **VLAN Table** as described above.
4. Double-click a port in the Port List. The port number appears in the Device Table, but no longer displays in the Available Ports List. When the port is removed from the VLAN the port redisplay in the Available Port List. The Selected Ports list displays the following fields:
 - ◆ **VLAN Port Number** – Indicates the port index number attached to the VLAN.
 - ◆ **VLAN Port Type** – Indicates if the port is static or active.
 - ◆ **Tagging** – Identifies the VLAN to which the frame belongs. To enable port tagging check the Enable port tagging checkbox.
 - ◆ **Forbidden Egress Port** – Indicates ports that are forbidden to be included in the Egress Ports List for this VLAN.
5. Click  to apply the new data.
6. Close the **VLAN Table Insert** window.



To delete ports from the Port Table:

1. Display the **VLAN Table** window.
2. In the **VLAN Table** window, click . The **VLAN Table Insert** window opens.
3. Highlight the port numbers of the ports you want to delete in the **Port Table**.
4. Click . The ports are highlighted and the port numbers appear in the Available Ports list.

To edit existing VLANs:

1. Display the **VLAN Table**.
2. Select an entry in the table.
3. Click . The **VLAN Table Edit** window opens. The window is identical to the **VLAN Table Insert** window.
4. Edit the required fields.
5. Click  to apply the new data.
6. Close the **VLAN Table Edit** window.

To delete existing VLANs:

1. Display the **VLAN Table**.
2. Select an entry in the table.
3. Click . The entry is deleted.
4. Click  to update the device.

Ethernet User-Defined Protocols

The **Ethernet User-Defined VLAN** window contains information regarding protocol names and the type of VLAN Ethernet.

To display the Ethernet User Defines VLAN window:

- ◆ Select **Device > VLAN > Ethernet** user defined protocols. The **Ethernet user defined vlans** window opens:

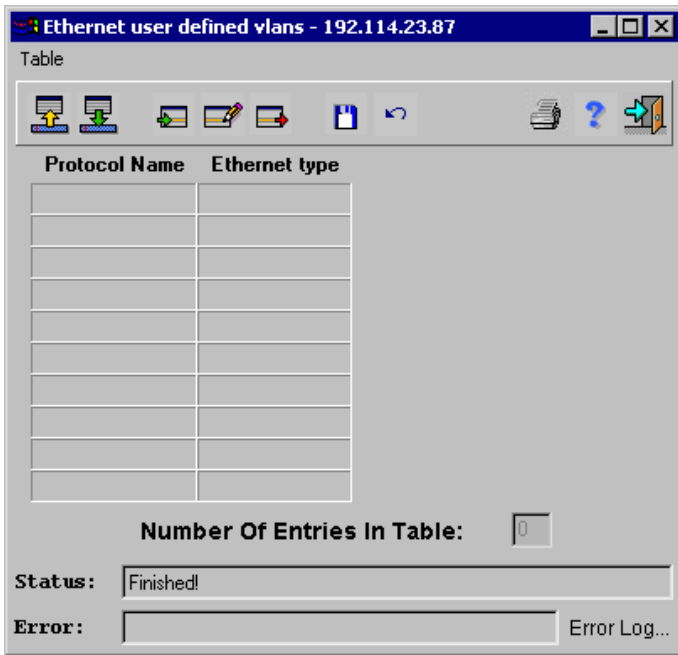



Figure 6- 44. Ethernet user defined vlans window

The **Ethernet user defined vlans** window displays the following fields:

- ◆ **Protocol name**— The user-defined protocol name.
- ◆ **VLAN Ethernet Type**—The user-defined VLAN Ethernet type.

To add a new Ethernet user-defined VLAN:

1. Display the **Ethernet user defined vlans** window.
2. Click . The **Ethernet user defined vlans Insert** window opens:

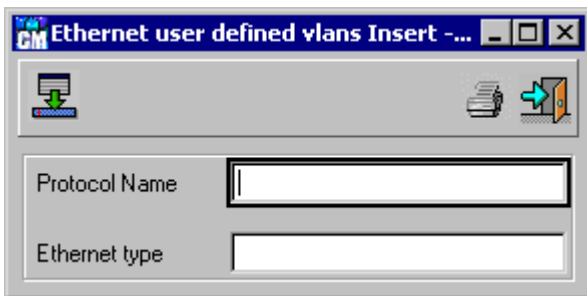





Figure 6- 45. Ethernet user defined vlans Insert window



3. Complete fields with the required information.
4. Click  to apply the new data.
5. Close the **Ethernet User-defined VLAN Insert** window.

To edit an existing Ethernet user-defined VLAN:

1. Display the **Ethernet User-defined VLANs** window.
2. Select a VLAN from the table.

3. Click . The **Ethernet User-defined VLANs Edit** window opens. The window is identical to the **VLAN Table Insert** window.
4. Edit the required fields.
5. Click  to update the device.
6. Close the **VLAN Table Edit** window.

To delete an Ethernet user-defined VLAN:

1. Display the **Ethernet User-defined VLANs** window.
2. Select an entry in the table.
3. Click . The entry is deleted.
4. Click  to update the device.

Configuring Ports

Port Properties

Use the **Port Properties** window to define parameters for the port selected in the front panel display or from the Select Port Number field in the **Port Properties** window.

Note: The **Port Properties** window can also be accessed by clicking  on the front panel display toolbar, or by right-clicking the selected port, or by pressing **Ctrl+T**.

To display the Port Properties screen:

- ◆ Select **Device > Port > Port Properties**. The **Port Properties** window opens. The **Port Properties** window has the following five tabs:
 - ◇ Main – Defines the general port settings including MAC address, port type, port description, speed, administration status, port status, and full or half duplex modes.
 - ◇ Other – Defines the back-pressure and flow control modes.
 - ◇ VLAN – Defines the VLAN settings on a port.
 - ◇ IP – Displays the IP addresses and network masks for a selected port.
 - ◇ IPX – Displays the network addresses and network masks for a port

The default opening screen is the **Main** tab. The following paragraphs illustrate and describe each screen tab.

The following figure illustrates the **Port Parameters** window **Main** tab.

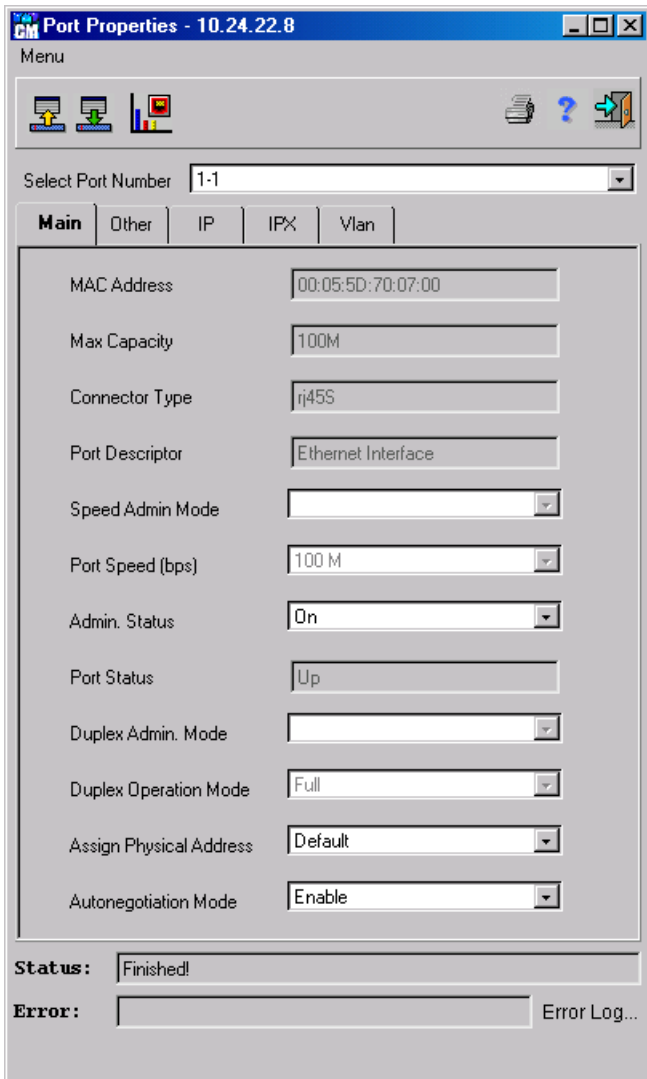

Figure 6- 46. Port Properties – Main tab

The **Main** tab displays the following fields:

- ◆ **MAC Address** – The interface Media Access Control (MAC) address.

Note: *Each router is assigned a unique MAC address by the system.*

- ◆ **Max Capacity** – The maximum capacity of the current port connection.
- ◆ **Connector Type** – The type of interface.
- ◆ **Port Descriptor** – Brief interface description, for example Ethernet.
- ◆ **Speed Admin Mode** – The possible LAN rate for the selected interface. The rate is selected from the field-configured options. For LAN interfaces only. (Auto-negotiation mode should be disabled).
- ◆ **Port Speed (bps)** – The synchronized port speed in bps.
- ◆ **Admin. Status** – Controls the traffic from the selected port. By default, this parameter is set to Enable. The options are as follows:
 - ◇ On – Select this option to permit the traffic through the port.
 - ◇ Off – Select this option to stop the traffic.

- ◆ **Port Status** – Indicates if the interface is operational (Up), non-operational (Down), or engaged in a test procedure so it does not carry traffic (Testing).
- ◆ **Duplex Admin Mode** – Specifies the conversation type for the interface. The options are as follows:
 - ◇ Full – The interface supports transmission between the device and the client in both directions simultaneously.
 - ◇ Half – The interface supports transmission between the device and the client in only one direction at a time.
- ◆ **Duplex Operation Mode** – The port synchronization mode.
- ◆ **Assign Physical Address** – To assign a physical address. The options are as follows:
 - ◇ Select Default to use the default address.
 - ◇ Reserve to assign a unique address (up to 264 unique addresses), in incrementing order.
- ◆ **Autonegotiation Mode** – This mode setting determines whether the Switch will automatically negotiate for the fastest possible connection. The options are as follows:
 - ◇ Enable – Select this option to enable the optimal connection speed.
 - ◇ Disable – Select this option to disable this feature.

To edit a Port Properties Main tab field:

1. Display the **Port Properties Main** tab.
 - ◆ Edit one of the following fields:
 - ◇ Speed Admin Mode.
 - ◇ Port Speed (bps).
 - ◇ Admin Status.
 - ◇ Duplex Admin Mode.
 - ◇ Duplex Operation Mode.
 - ◇ Assign Physical Address.
2. Click . When the Status field displays “Finished!”, the fields are confirmed as modified.

The following figure illustrates the **Port Parameters** window **Other** tab:

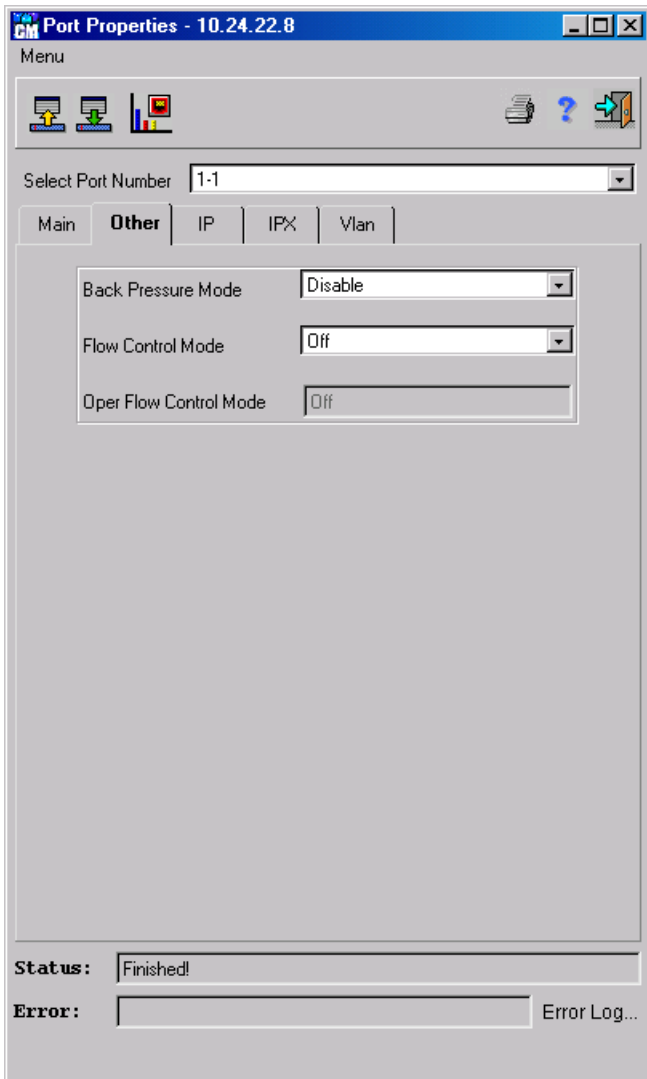

Figure 6- 47. Port Properties – Other tab

The **Other** tab displays the following fields:

- ◆ **Back Pressure Mode** – Disabled by default. By enabling back-pressure, the device signals the accompanying partner device to hold onto the traffic, whenever a certain speed is reached.
- ◆ **Flow Control Mode** – To control packet transmissions. The options are as follows:
 - ◇ On – Activates the flow control mechanism. The accompanying device behavior has no affect on the feature.
 - ◇ Off – Disables the feature. *Off* is the default setting.
 - ◇ AutoNegotiation – The port sends the device flow control packets (as long as it is supported by the other device).
 - ◇ EnabledRx – The port allows packets to be received only.
 - ◇ EnabledTx – The port allows packets to be transmitted only.
- ◆ **Open Flow Control Method** – This read-only field displays whether this feature is currently enabled or not.

Note: When modifying Flow Control and Back Pressure, The HOL setting is automatically changed:

- ◆ Flow Control set to ON – HOL automatically resets to OFF

- ◆ Back Pressure set to Enable – HOL automatically resets to OFF

Note: *If a configured port goes down due to either an Administrative or physical link, the HOL resets to ON even if the Flow Control on port was configured to ON.)*

To edit an Other tab field:

1. Display the **Port Properties Main** tab.
2. Edit the required field.
3. Click . When the Status field displays “Finished!”, the fields are confirmed as modified.

The following figure illustrates the **Port Parameters** window **VLAN** tab:

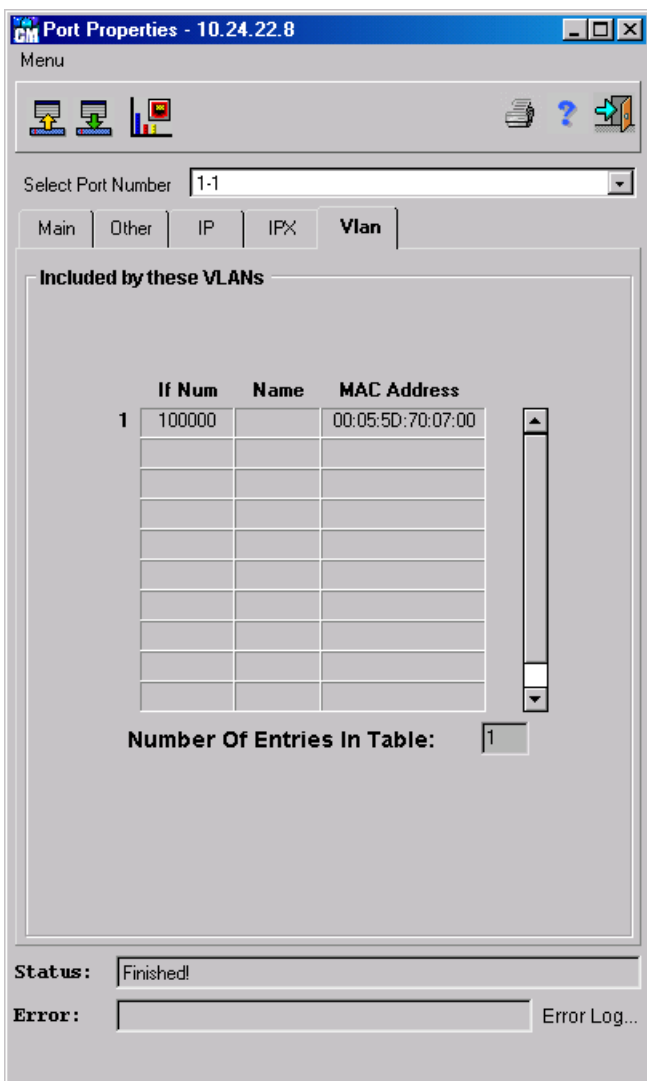

Figure 6- 48. Port Properties – VLAN tab

The **VLAN** tab displays the following fields:

- ◆ If Number/Name/MAC Address – The number/name/MAC address of VLANs in which the selected port is included.

The following figure illustrates the **Port Parameters IP** tab:

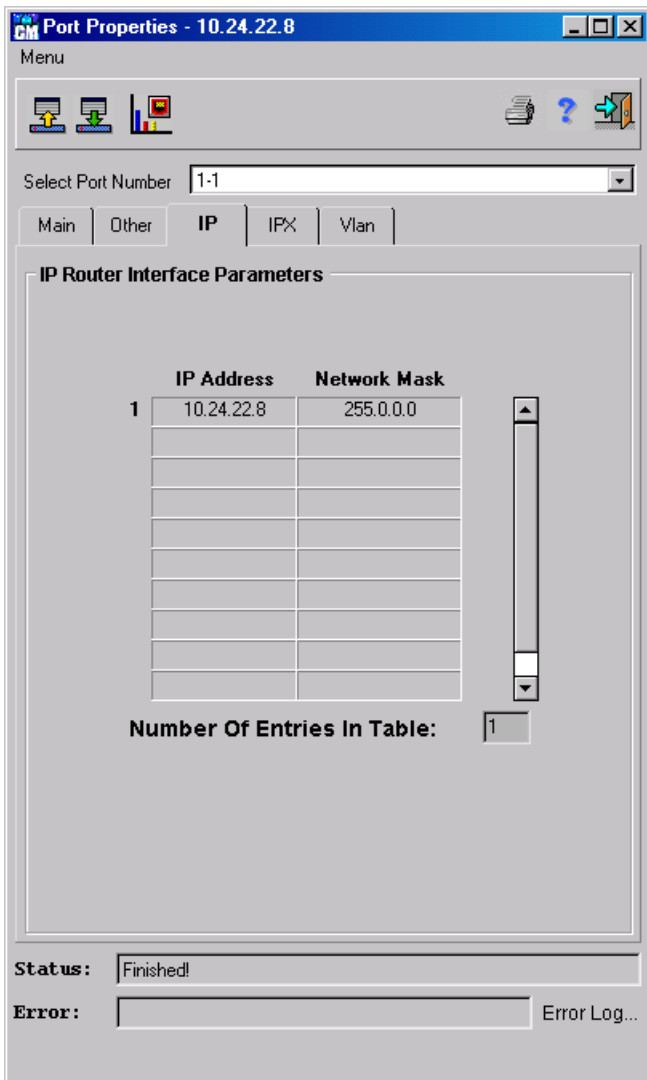

Figure 6- 49. Port Properties – IP tab

The **IP** tab displays the following address information defined for the selected port:

- ◆ **IP address** – Displays the IP address of port.
- ◆ **Network Mask** – Displays the network masked used to mask parts of the IP address.

The following figure illustrates the **Port Parameters** window **IPX** tab:

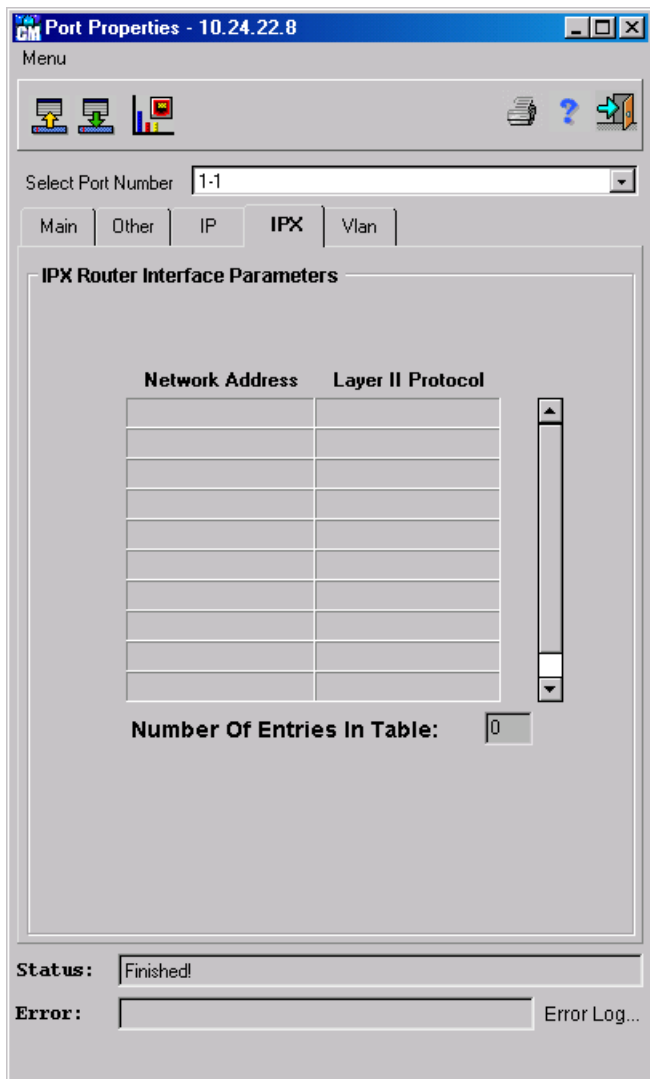

Figure 6- 50. Port Properties – IPX tab

The **IPX** tab displays the following address information defined for the selected port:

- ◆ **Network Address** – Displays the network address on which the port is located.
- ◆ **Layer II Protocol** – Displays the Layer II protocol type enabled on the port.

Port Mirroring

Port Mirroring allows you to copy traffic from one port to another port. To display the **Port Mirroring** window:

- ◆ Select **Device > Port > Port Mirroring**. The **Port Mirroring** window opens:

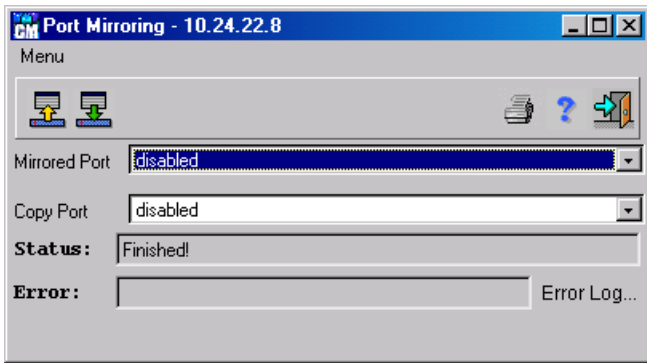



Figure 6- 51. Port Mirroring window

The **Port Mirroring** window displays the following fields:

- ◆ **Mirrored Port** – Defines the port number from which all outgoing and incoming traffic is copied. The possible values are:
 - ◇ Disabled – Disables port mirroring.
 - ◇ Port List – A list of port numbers. Select the port from the drop-down list. If selected, traffic is mirrored from that port only.
- ◆ **Copy Port** – Defines the port number to which all outgoing and incoming traffic is mirrored. A copy port cannot mirror itself, be a member of a VLAN, or be configured with an IP or IPX interface. The possible values are:
 - ◇ Disabled – Disables port mirroring.
 - ◇ Port List – A list of port numbers. Select the port from the drop-down list. If selected traffic is mirrored to that port only.

Note: *Port mirroring may cause network congestion. This may result in the dropping of packets that are being mirrored to the copy port due to lack of network resources.*

To enable port mirroring on a device:

1. Display the **Port Mirroring** window.
2. Complete the fields. The fields are the same as the **Port Mirroring** window as described above.
3. Click . When the **Status** field displays “Finished!”, Port Mirroring is enabled on the device.

Storm Control

Use the **Storm Control Parameters** window to display parameters for storm control.

To display the Storm Control Parameters window:

- ◆ Select **Device > Port > Storm Control > Storm Ctrl Parameters**. The **Storm Control Parameters** window opens:

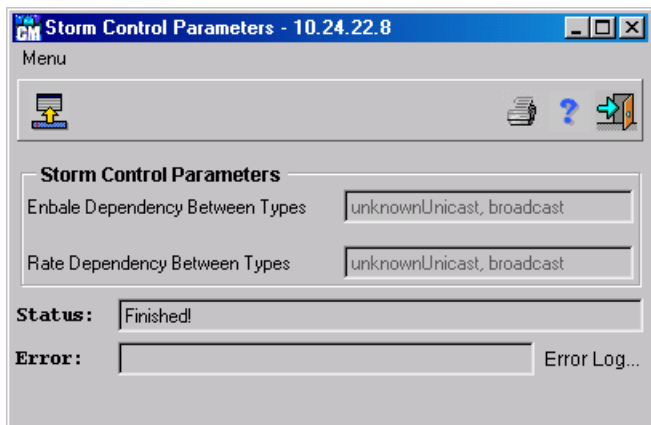

Figure 6- 52. Storm Control Parameters window

Use the **Storm Control Table** window to display the whole table as well as to edit individual entries.

To display the Storm Control Table window:

- ◆ Select **Device > Port > Storm Control > Storm Ctrl Table**. The **Storm Control Table** window opens:

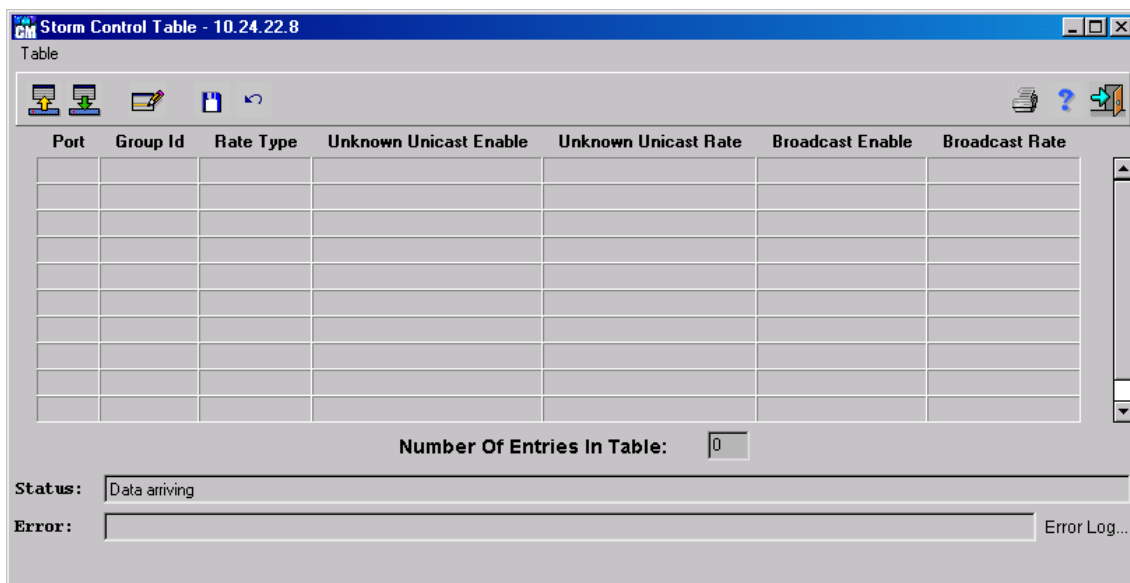



Figure 6- 53. Storm Control Table window

To edit an existing Storm Control entry:

1. Display the **Storm Control Table** window.
2. Select an entry from the table.
3. Click . The **Storm Control Table Edit** window opens:

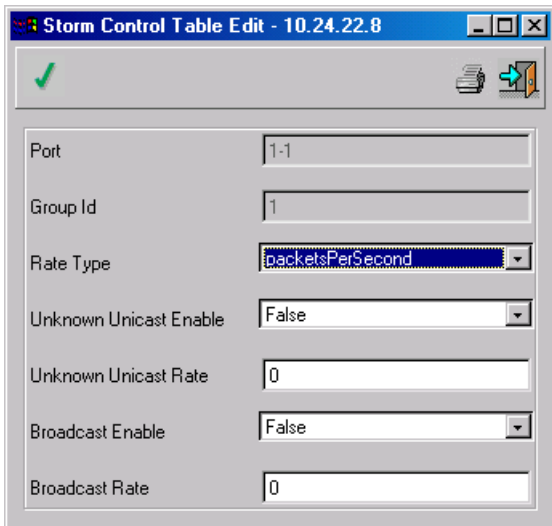



Figure 6- 54. Storm Control Table Edit window

4. Edit the required fields.
5. Click  and close the **Storm Control Table Edit** window.
6. Click  to update the device.

Configuring GVRP and Trunking

GVRP

Generic Attribute Registration Protocol (GARP) protocol is a general-purpose protocol that registers any network connectivity or membership-style information. GARP defines a set of devices interested in a given network attribute, such as VLAN or multicast address.

GARP VLAN Registration Protocol (GVRP) protocol is specifically provided for automatic distribution of VLAN membership information among VLAN-aware bridges. GVRP allows VLAN-aware bridges to automatically learn VLANs to bridge ports mapping, without having to individually configure each bridge, and to register VLAN membership.

To minimize the memory requirements when running the GVRP protocol, two proprietary tuning variables have been added to the standard variables:

- ◆ Maximum number of GVRP VLANs – Displays the number of GVRP VLANs allowed to participate in GVRP operation.
- ◆ Maximum number of GVRP VLANs after Reset – Sets another value of GVRP VLANs. *Maximum number of GVRP VLANs after Reset* is used for tuning. This value becomes valid after reset only.

The maximum number of GVRP VLANs includes all the VLANs participating in GVRP operation regardless if they are static or dynamic.

The following should be considered when specifying the maximum number of VLANs participating in GVRP by setting the *Maximum number of GVRP VLANs after Reset* value:

- ◆ The default maximum number of GVRP VLANs is equal to 0 because of the memory restrictions.
- ◆ The maximum number of VLANs (managed through Max VLANs MIB variable) limits the maximum number of GVRP VLANs.

- ◆ To ensure the correct operation of the GVRP protocol, users are advised to set the maximum number of GVRP VLANs equal to a value that significantly exceeds the sum of:
 - ◇ The number of all static VLANs both currently configured and expected to be configured.
 - ◇ The number of all dynamic VLANs participating in GVRP both currently configured (initial number of dynamic GVRP VLANs is 0) and expected to be configured.

Increasing the value of maximum number of GVRP VLANs to value beyond the sums, allows users to run GVRP, and not reset the device to receive a larger amount of GVRP VLANs. For example, if 3 VLANs exist and another two VLANs are expected to be configured as a result of VLAN static or dynamic registration, set the maximum number of GVRP VLANs after reset to 10.

Note: To enable GVRP, ensure that the amount of maximum amount of VLANs is less than 4000. For more information, see the Device Tuning section later in this manual.

To configure the GVRP feature:

1. Enable GVRP on a device.
2. Enable GVRP per port to participate in GVRP.
3. Specify the maximum number of GVRP VLANs after reset.
4. Reset the device to receive the new maximum number of GVRP VLANs set.

To increase the number of Maximum GVRP VLANs and to reconfigure the GVRP protocol:

1. Specify a new value of the maximum number of GVRP VLANs after reset.
2. Reset the device.
3. Check that the new value is displayed in the Max GVRP VLANs field.

For more information about configuring the Maximum number of GVRP VLANs and Maximum number of GVRP VLANs after Reset fields, see the Device Tuning section later in this manual.

Consideration Concerning STP And GVRP Operation

The circulation of GARP/GVRP registration information follows through the Bridged LANs active topology and it is assumed that the STP protocol is established and maintained.

Note: When operating in the *STP per device* mode with the *Must belong to VLAN* parameter set to True, STP reacts to GVRP enabled on a port as if a VLAN was created on this port

Note: When operating in the *STP per VLAN* mode, every port that GVRP is enabled on is included into a specifically reserved VLAN. This VLAN is established to ensure the GVRP proper operation.

GVRP Parameters

The **GVRP Parameters** window contains information about GVRP and whether GVRP is enabled on specific ports. The **GVRP Parameters** window contains two tabs:

- ◆ **Device Parameters** – Indicates if GVRP is currently enabled on a device.
- ◆ **Ports Parameters** – Displays information about the individual ports and whether or not GVRP is enabled on specific ports.

To display the GVRP Parameters window:

Select **Device > GARP > GVRP > Parameters**. The **GVRP Parameters** window opens. The **GVRP Parameters** window has two tabs:

- ◆ **Device Parameters** – Displays the options enabling or disabling the GVRP on a device.

◆ **Port Parameters** – Displays the status of GVRP on individual ports.

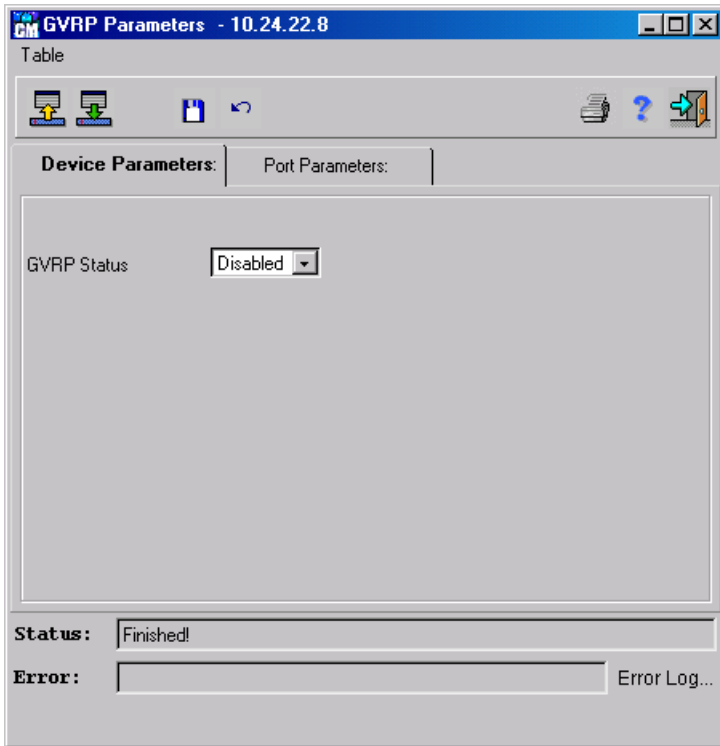



Figure 6- 55. GVRP Parameters – Device Parameters tab

The **GVRP Parameter – Device Parameters** tab displays the following parameters:

◆ **GVRP Status** – Indicates if GVRP is enabled on a device, except for specific ports for which GVRP is disabled. If the GVRP status is disabled on all ports, GVRP packets are discarded.

To enable a GVRP on a device:

1. Display the **GVRP Parameters** window.
2. Right-click on GVRP Status and select *Enabled*.
3. Click  to update the device. When the Status field displays “Finished!”, the GVRP is enabled.

The **GVRP Parameters – Port Parameters** tab displays the following parameters:

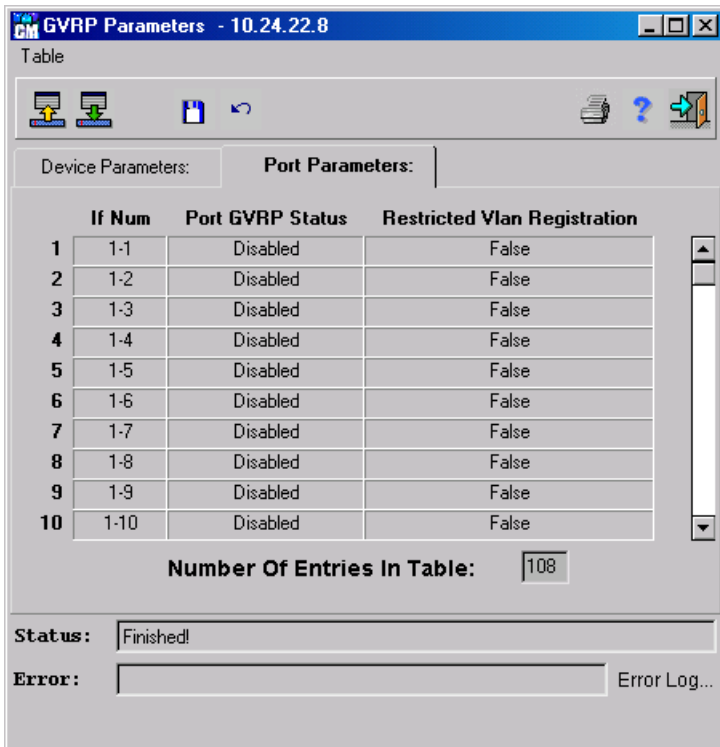

Figure 6- 56. GVRP Parameters – Port Parameters tab

- ◆ **If Num** – Indicates the port number.
- ◆ **Port GVRP Status** – Indicates if GVRP is enabled on a port.

GVRP Timers Control

The **GVRP Timers Control** window contains information about timers for every bridged port.

Note: *When modifying the default timer values, the Leave value must be greater than three times the Join value and the Leave All value must be greater than the Leave value:*

- ◆ Leave Time $\geq 3 \times$ Join Time
- ◆ Leave All Time $>$ Leave Time

To display the GVRP Timers Control window:

- ◆ Select **Device > GARP > GVRP > Timers Control**. The **Timers Control** window opens:

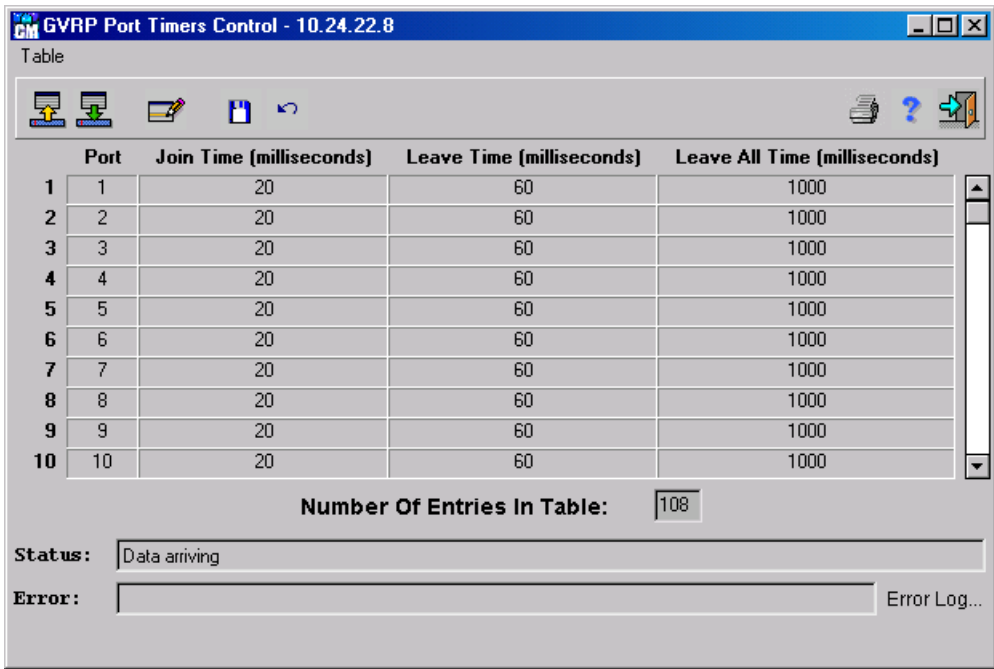

Figure 6- 57. GVRP Port Timers Control window

The **GVRP Timers Control** window displays the following parameters:

- ◆ **If Num** – Indicates the port number for which GVRP is enabled.
- ◆ **Join Time** – Indicates the time in milliseconds that PDUs are transmitted.
- ◆ **Leave Time** – Indicates the time lapse in milliseconds that the device waits before leaving its GVRP state. The Leave Time is activated by a Leave All Time message sent/received, and cancelled by the Join message received.
- ◆ **Leave All Time** – Used to confirm the port within the VLAN. The time in milliseconds between messages sent.

To Edit a Timer Control:

1. Display the **GVRP Port Timers Control** window.
2. Select an entry in the **GVRP Port Timers Control** table.
3. Click . The **GVRP Port Timers Edit** window opens:

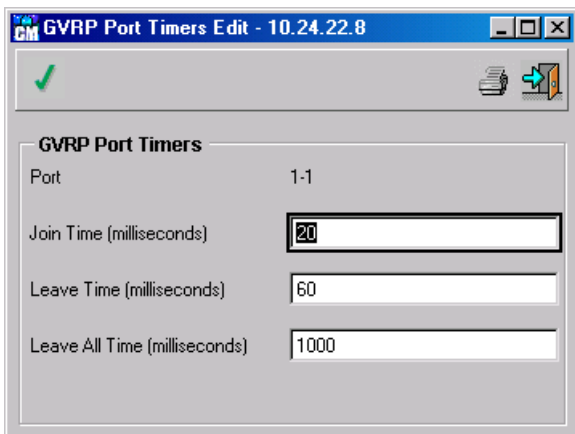



Figure 6- 58. GVRP Port Timers Edit window

1. Edit the fields. The fields are the same as the **GVRP Timers Control** window as described above.

2. Click . The **GVRP Port Timers Edit** window closes.
3. Click . When the Status field displays “Finished!”, the timer control settings are saved to the device.

Note: *The necessity to modify the default timer values arises when the number of VLANs participating in GVRP operation approaches approximately 200 VLANs. A network administrator is advised to increase the default values of Leave and Leave All timers.*

GVRP Information

The **GVRP Information** window contains information about failed registrations and MAC address of GVRP messages received on individual ports.

To display the GVRP Information window:

- ◆ Select **Device > GARP > GVRP > Information**. The **GVRP Information** window opens:

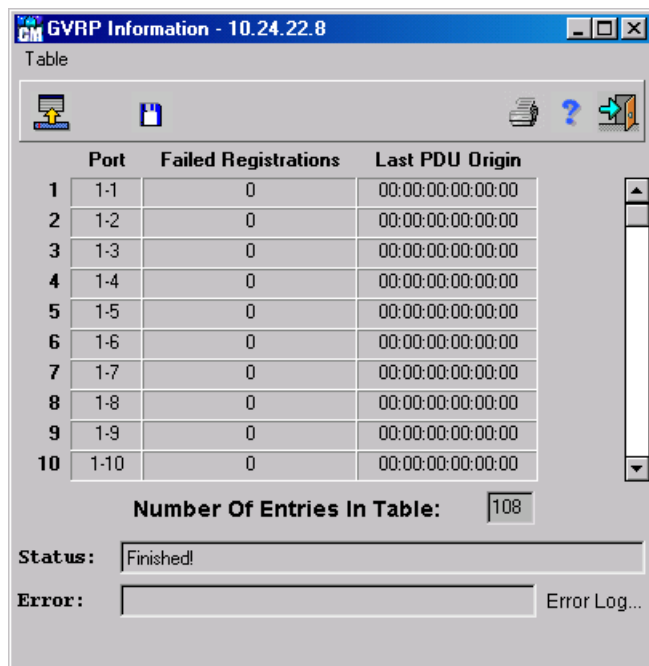

Figure 6- 59. GVRP Information window

The **GVRP Information** window displays the following parameters:

- ◆ **If Num** – Indicates the active port number.
- ◆ **Failed Registrations** – The total number of failed GVRP registrations on this port.
- ◆ **Last PDU Origin** – The source MAC Address of the last GVRP message received on this port.

Trunk

Trunking (Link Aggregation) optimizes port usage by linking a group of ports together to form a single trunk (aggregated groups). Trunking multiplies the bandwidth between the devices, increases port flexibility, and provides link redundancy.

Trunk Parameters

The **Trunking Parameters** window displays information about the number of trunks on a device, the number of ports included in a trunk, and the MIB software version currently running.

To display the Trunk Parameters window:

- ◆ Select **Device > Trunk > Parameters**, the **Trunk Parameters** window opens:

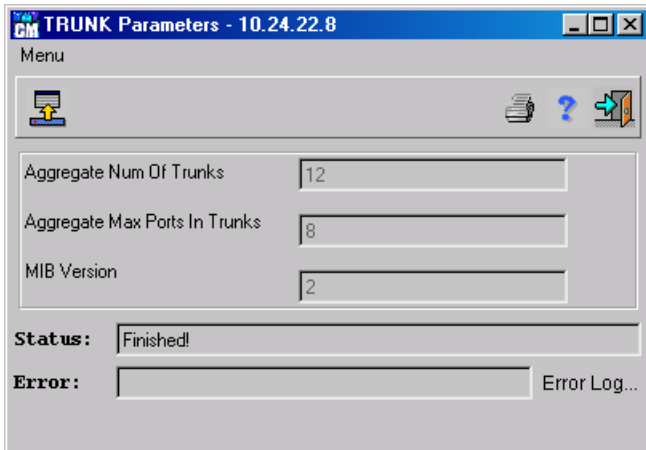

Figure 6- 60. Trunk Parameters window

The **Trunk Parameters** window displays the following fields:

- ◆ **Aggregate Num. of Trunks** – Indicates the number of trunks supported by the device.
- ◆ **Aggregate Max Ports In Trunks** – Indicates the maximum number of ports that can make up a trunk.
- ◆ **MIB Software version** – Indicates the MIB Software version currently running.

Trunk Table

The **Trunk Table** contains information specific to trunks including the ports that make up the trunks. The Trunk Table allows network managers to assign ports to trunks. In order to assign a trunk a port, the port must comply with the following requirements:

A Layer 3 interface is not configured on the port.

- ◆ A VLAN is not configured on the port.
- ◆ A port is not assigned to a different trunk.
- ◆ An available MAC address exists which can be assigned to a port.
- ◆ Auto-negotiation mode is not configured on the port.
- ◆ The port is in full-duplex mode.
- ◆ All ports must operate at the same rate.
- ◆ All ports must have the same ingress filtering and tagged modes.
- ◆ All ports must have the same back pressure and flow control modes.
- ◆ All ports must have the same priority.
- ◆ All ports must have the same transceiver type.

To display the Trunk Port Table:

- ◆ Select **Device > Trunk > Trunk Table**, the **Trunk Table** opens:

TRUNK Table - 10.24.22.8

Table

Index	Trunk MAC Address	Aggregate	Ports Included
1	97	00:05:5D:70:07:00	True
2	98	00:05:5D:70:07:00	True
3	99	00:05:5D:70:07:00	True
4	100	00:05:5D:70:07:00	True
5	101	00:05:5D:70:07:00	True
6	102	00:05:5D:70:07:00	True
7	103	00:05:5D:70:07:00	True
8	104	00:05:5D:70:07:00	True
9	105	00:05:5D:70:07:00	True
10	106	00:05:5D:70:07:00	True

Number Of Entries In Table:

Status:

Error: Error Log...

Figure 6- 61. Trunk Table window

The **Trunk Table** window displays the following fields:

- ◆ **Index** – Indicates the trunk ifIndex.
- ◆ **Trunk MAC Address** – Indicates the MAC Address of the Trunk.

Note: The device's MAC address displays by default, unless a MAC address is reserved for a trunk.

- ◆ **Aggregate** – Indicates if the trunk currently contains ports. The possible values are:
 - ◇ True – The trunk contains ports.
 - ◇ False – The trunk does not contain ports.
- ◆ **Ports Included** – Identifies the ports that are part of the trunk.

To Add or Edit the Aggregated Port List Port field:

1. Display the **Trunk Table**.
2. Select an entry in the **Trunk Table**.
3. Click . The **Trunk Table** window opens.

or

Double-click an entry in the **Trunk Table**, the **Trunk Table- Edit** window opens:

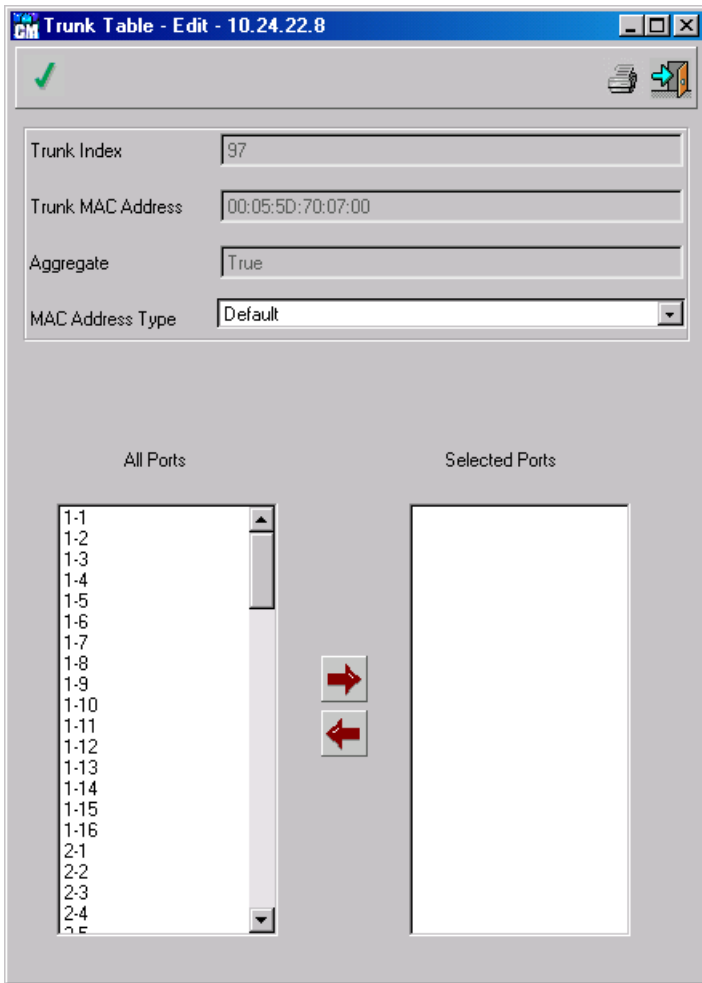





Figure 6- 62. Trunk Table- Edit window

4. Edit the ports list using   to move ports between the All Ports and Forbidden Port lists. The MAC address type can also be modified. The possible values are:
 - ◆ **Reserved** – The Trunk is assigned a unique MAC address based on the order of which it was configured (0-4096 reserved MAC addresses).
 - ◆ **Default** – The Trunk receives the device MAC address.
5. Click . The **Trunk Table- Edit** window closes.
6. Click . When the Status field displays “Finished!”, the ports that have been associated with a trunk are saved to the device.

Trunking Port Table

The **Trunking Port Table** displays information regarding about the individual ports that make up trunks.

To display the Trunking Port Table:

- ◆ Select **Device > Trunk > Ports Table**, the **Trunking Port Table** opens:

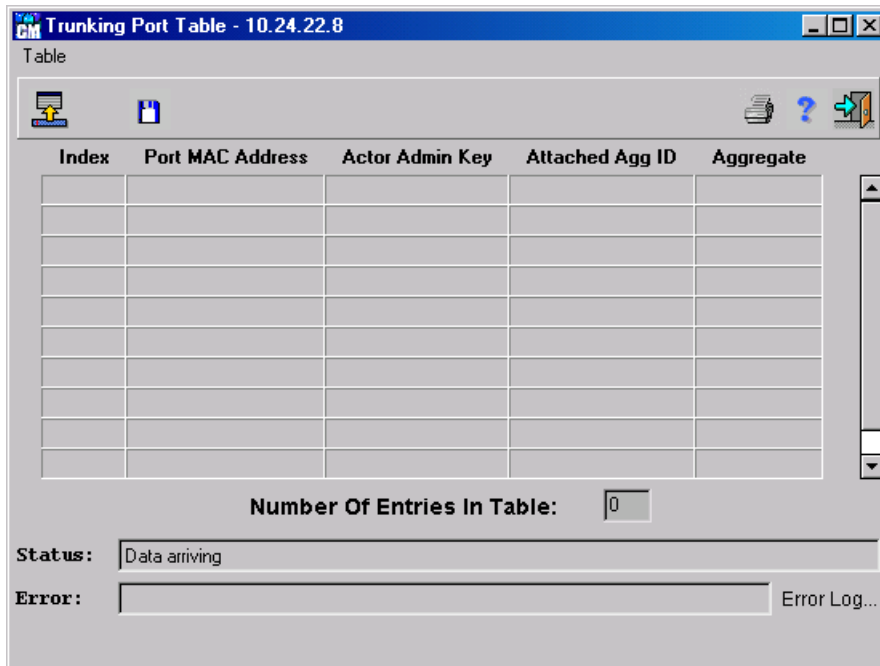

Figure 6- 63. Trunking Port Table window

The **Trunking Port Table** window displays the following fields:

- ◆ **Index** – Identifies the individual port number.
- ◆ **Port MAC Address** – Identifies the MAC address of the port that contains the trunk.
- ◆ **Actor Admin Key** – Indicates the key value of the port. Key values are assigned to ports to signify that ports can be trunked together. For example, all ports with a key value of 5 can be trunked together, while all ports with a key value of 8 can form a different trunk. A value of 0 deletes an existing port from a trunk. A port with an unassigned key value can be aggregated to a trunk.
- ◆ **Attached Agg ID** – Identifies the trunk ifIndex to which the port is attached.
- ◆ **Aggregated** – Indicates if the port is trunked. The possible values are:
 - ◇ True – Indicates that the port is part of a trunk.
 - ◇ False – Indicates that the port is not part of a trunk.

Trunk Balance Table

The **Trunk Balance Table** displays information about the criteria for balancing the corresponding trunk indexes.

To display the Trunk Balance Table:

- ◆ Select **Device > Trunk > Trunk Balance Table**, the **Trunk Balance Table** opens:

Table

Index	Forward Type	Layer	Used Addresses	Broadcast Type	
1	97	Bridging	2	dstAddr	Common
2	97	Routing	3	dstAddr	Common
3	98	Bridging	2	dstAddr	Common
4	98	Routing	3	dstAddr	Common
5	99	Bridging	2	dstAddr	Common
6	99	Routing	3	dstAddr	Common
7	100	Bridging	2	dstAddr	Common
8	100	Routing	3	dstAddr	Common
9	101	Bridging	2	dstAddr	Common
10	101	Routing	3	dstAddr	Common

Number Of Entries In Table:

Status:

Error: Error Log...

Figure 6-64. Trunk Balance Table window

The **Trunk Balance Table** window displays the following fields:

- ◆ **Index** – Identifies the trunk number.
- ◆ **Forward Type** – Balances the trunk in either 1 of 2 modes. The possible values are:
 - ◇ Bridging
 - ◇ Routing
- ◆ **Layer** – Specifies the Balance Layer that the trunk used for the specified Forward Type, the possible values are:
 - ◇ 2 – Indicates that layer 2 is being used as the balance layer.
 - ◇ 3 – Indicates that layer 3 is being used as the balance layer.
 - ◇ 4 – Indicates that layer 4 is being used as the balance layer.
- ◆ **Used Addresses** – Specifies the network layer addresses used for balancing unicast frames. The possible values are:
 - ◇ NotApplied – Indicates that a network layer address is not used for balancing unicast frames.
 - ◇ DstAddr – Indicates that the destination address is used for balancing unicast frames.
 - ◇ ScrAddr – Indicates that the source address is used for balancing unicast frames.
 - ◇ DstadrnSrcAdd – Indicates that both the source and destination addresses are used for balancing unicast frames.
 - ◇ VlanID – Indicates that the VLAN ID is used for balancing unicast frames.
 - ◇ EthType – Indicates that the ethernet type is used for balancing unicast frames.
- ◆ **Broadcast Type** – Specifies the criterion used for balancing L2 broadcast and unknown frames. The possible values are:
 - ◇ Common – A link allocated for broadcast and unknown frames is used for also for unicast frames.

- ◇ Dedicated – A link allocated for broadcast and unknown frames is not used for unicast frames.

Configuring Bridging

This section describes the **Bridge** menu and its options, including unicast and multicast routing, spanning tree and rapid spanning tree settings, MAC multicast routing, and traffic control.

Once a VLAN is defined, bridging is performed within the VLAN. For example if a DECnet VLAN is defined on ports 1 and 2, DECnet packets into port 1 are bridged to port 2 and DECnet packets into port 2 are bridged to port 1.

Operating Parameters

The **Operating Parameters** window allows you to define general parameters for bridging.

To display the Bridge Operating Parameters window:

- ◇ Select **Bridge > Operating Parameters**. The **Bridge Operating Parameters** window opens:

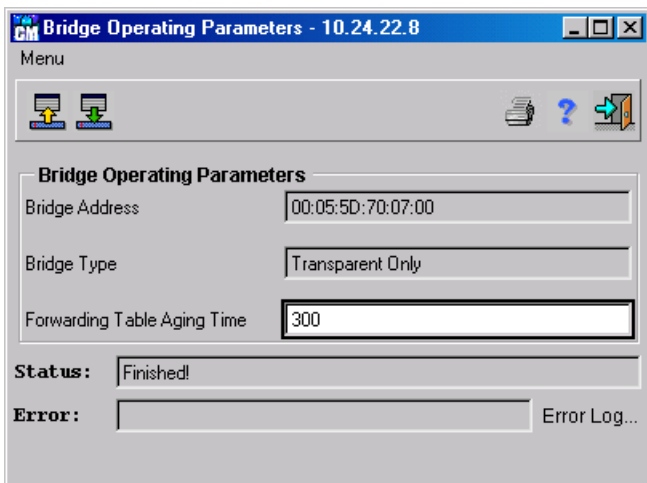



Figure 6- 65. Bridge Operating Parameters window

The **Bridge Operating Parameters** window displays the following fields:

- ◇ **Bridge Address** – The device MAC address.
- ◇ **Bridge Type** – Types of bridging the device can perform. This is a read only field, whose value is Transparent Only.
- ◇ **Forwarding Table Aging Time** – The user-defined number of seconds the learned entries remain in the **Forwarding Table**. The counter is reset each time the entry is used. After this time, entries are deleted from the table. There is a minimum 10-second period.

To edit the Forwarding Table Aging Time field:

1. Display the **Bridge Operating Parameters** window.
2. Edit the Forwarding Table Aging Time field.
3. Click . When the Status field displays “Finished!”, the fields are confirmed as modified.

Unicast

Unicast is a method of sending one packet to one destination, for example between a workstation and a server. The **Unicast** menu has the following options:

- ◆ Unicast Global Forwarding Table.
- ◆ Unicast Forward Table Size.

Unicast Global Forwarding Table

The **Unicast Forwarding Table** contains information about MAC Addresses that belong to a specific VLAN.

To display the Unicast Global Forwarding Table:

- ◆ Select **Bridge > Unicast > Unicast Global Forwarding Table**. The **Unicast Global Forwarding Table** opens:

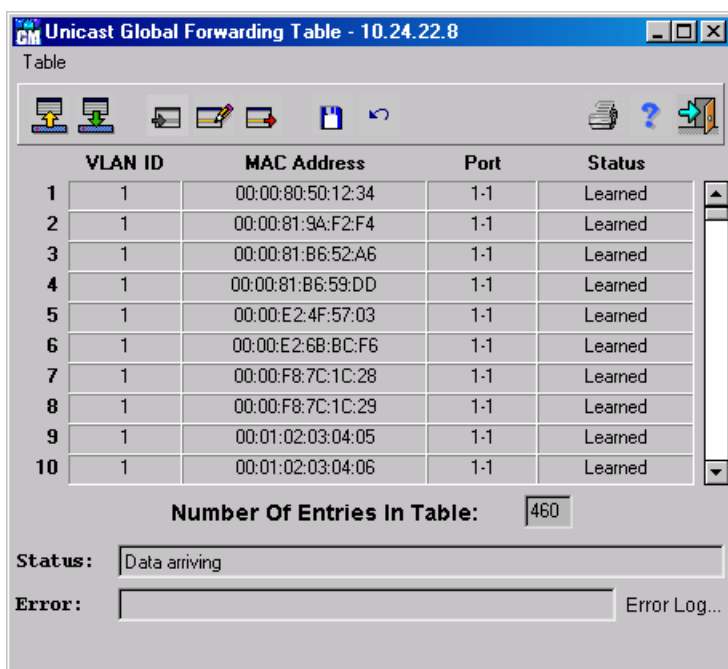

	VLAN ID	MAC Address	Port	Status
1	1	00:00:80:50:12:34	1-1	Learned
2	1	00:00:81:9A:F2:F4	1-1	Learned
3	1	00:00:81:B6:52:A6	1-1	Learned
4	1	00:00:81:B6:59:DD	1-1	Learned
5	1	00:00:E2:4F:57:03	1-1	Learned
6	1	00:00:E2:6B:BC:F6	1-1	Learned
7	1	00:00:F8:7C:1C:28	1-1	Learned
8	1	00:00:F8:7C:1C:29	1-1	Learned
9	1	00:01:02:03:04:05	1-1	Learned
10	1	00:01:02:03:04:06	1-1	Learned

Number Of Entries In Table: 460

Status: Data arriving

Error: Error Log...

Figure 6- 66. Unicast Global Forwarding Table window

The **Unicast Global Forwarding Table** displays the following fields:

- ◆ **VLAN ID** – Identifies the VLAN to which the MAC Address applies.
- ◆ **MAC Address** – Identifies the Group MAC address of a frame to which the filtering information applies.
- ◆ **Port** – Identifies the specific port through which the MAC Address was learned.
- ◆ **Status** – Indicates the port status. The possible values are:
 - ◆ Learned – The entry was automatically learned.
 - ◆ Self – The entry is a port on the device.
 - ◆ Mgmt – The entry is a static node manually entered using the  button.
 - ◆ Other – Node status cannot be described by one of the above.

To add a new entry in the Unicast Global Forwarding Table:

1. Display the **Unicast Global Forwarding Table**.
2. Double-click an empty row in the **Unicast Global Forwarding Table**.

or

Click . The **Unicast Global Forwarding Table Insert** window opens:

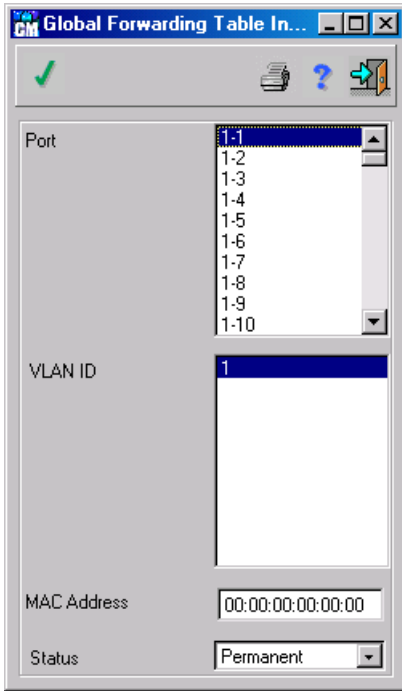



Figure 6- 67. Global Forwarding Table Insert window

3. Complete the fields. The fields are the same as those for **Unicast Global Forwarding** as described above.
4. Click . The **Global Forwarding Table Insert** window closes.
5. Click  to update the device. When the Status field displays “Finished!”, the entry is saved to the device.

To edit an entry in the Global Forwarding Table:

1. Display the **Global Forwarding Table**.
2. Double-click an entry in the **Global Forwarding Table**.

or

Click . The **Global Forwarding Table Edit** window opens:

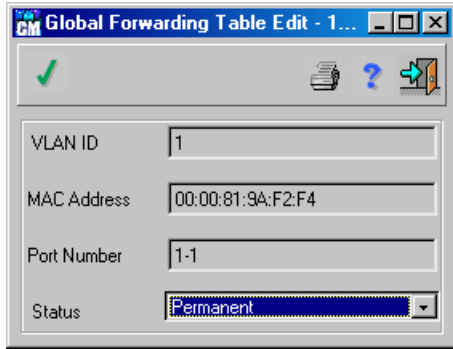





Figure 6- 68. Global Forwarding Table Edit window

3. Edit the fields. The fields are the same as those for **Unicast Global Forwarding** as described above.
4. Click . The **Global Forwarding Table Edit** window closes.
5. Click . When the Status field displays “Finished!”, the profile is saved to the device.

To delete an entry in the Global Forwarding Table:

1. Display the **Global Forwarding Table**.
2. Select an entry in the **Global Forwarding Table**.
3. Click . The entry is deleted from **Global Forwarding Table**.
4. Click  to update the device. When the Status field displays “Finished!”, the entry is deleted from the device.

Unicast Forward Table Size

The **Unicast Forward Table Size** contains information about VLANs and their entries.

To display the Unicast Forward Table Size Window:

- ◆ Select **Bridge > Unicast > Unicast Global Forwarding Table Size**. The **Unicast Forward Table Size** window opens:

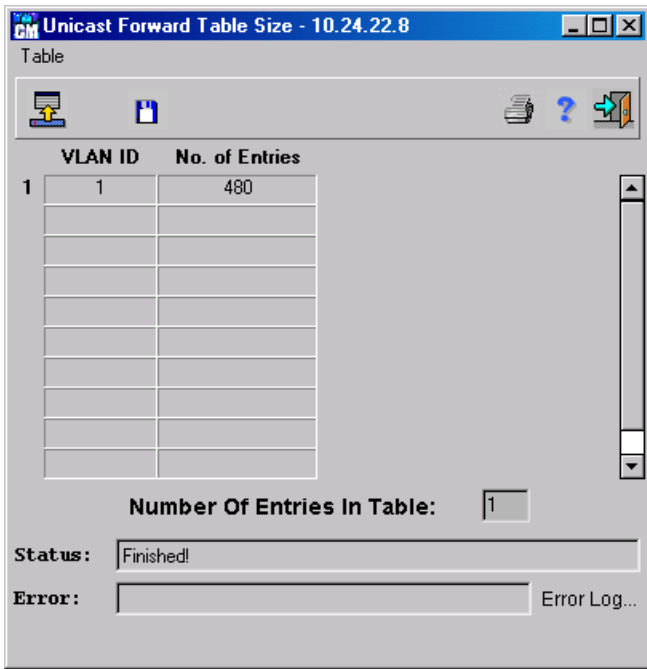

Figure 6- 69. Unicast Forward Table Size window

The **Unicast Forward Table Size** window displays the following fields:

- ◆ **VLAN ID** – Indicates the VLAN on which the Unicast mode is enabled.
- ◆ **No. of Entries** – Indicates the amount VLAN entries.

Spanning Tree

The Spanning Tree Protocol (STP) provides tree topography for any arrangement of bridges. STP provides one path between end stations on a network, eliminating loops. STP is implemented either:

- ◆ STP per Device.
- ◆ Spanning Tree per VLAN.

ConfigMaster supports and automatically recognizes if the device is running STP per device or STP per VLAN.

Note: When changing the STP setting from STP per Device to STP per VLAN or visa versa, the device must be reset. ConfigMaster must be closed and reopened for the change to be viewed.

STP per Device

The following windows apply to STP per device. STP can be implemented on a per device basis.

Parameters

The **Spanning Tree Parameters** window allows you to set the parameters for the Spanning Tree per device.

To display the Spanning Tree Parameters window:

- ◆ Select **Bridge > Spanning Tree > Parameters**. The **Spanning Tree Parameters** window opens:

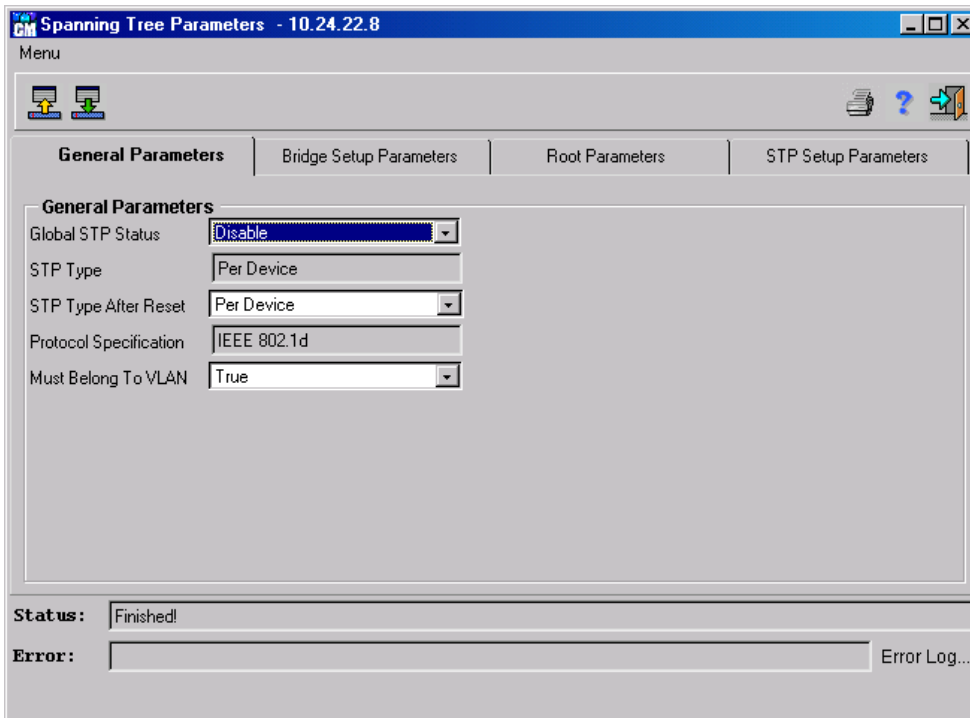

Figure 6- 70. Spanning Tree Parameters window General Parameters tab

The **Spanning Tree Parameters** window displays the following fields:

- ◆ **General Parameters** – Defines general information about the Spanning Tree Mode on a device or VLAN, including the protocol specification, and if a port must belong to a VLAN. These parameters can be modified.
- ◆ **Bridge Setup Parameter** – Identifies the root bridge's parameters.
- ◆ **Root Parameters** – Contains information regarding the root. These fields are grayed out and cannot be modified. The fields appearing in this tab are grayed out.
- ◆ **STP Setup Parameters** – Contains information regarding the STP Setup. These fields are grayed out and cannot be modified.

The **General Parameters** tab displays the following fields:

- ◆ **Global STP Status** – Indicates the STP status. The possible values are:
 - ◇ Enabled – STP is enabled.
 - ◇ Disabled – STP is disabled.
- ◆ **STP Type** – Indicates if the STP mode is per device or per VLAN.
- ◆ **STP Type After Reset** – Indicates the STP setting after the device is reset. The device must be reset for the change to be implemented. The possible values are:
 - ◇ Per Device – Indicates that the STP mode is per device.
 - ◇ Per VLAN – Indicates that the STP mode is per VLAN.

Note: *STP per VLAN isn't supported in the present software release.*

- ◆ **Protocol Specification** – Indicates the protocol type. This field is a read only.
- ◆ **Must belong to VLAN** – Indicates if ports must belong to a defined VLAN. The possible values are:
 - ◇ True – Indicates that ports must belong to a defined VLAN to be in the STP mode.

- ◇ False – Indicates that each port of a device is in STP mode, whether or not a VLAN was defined.

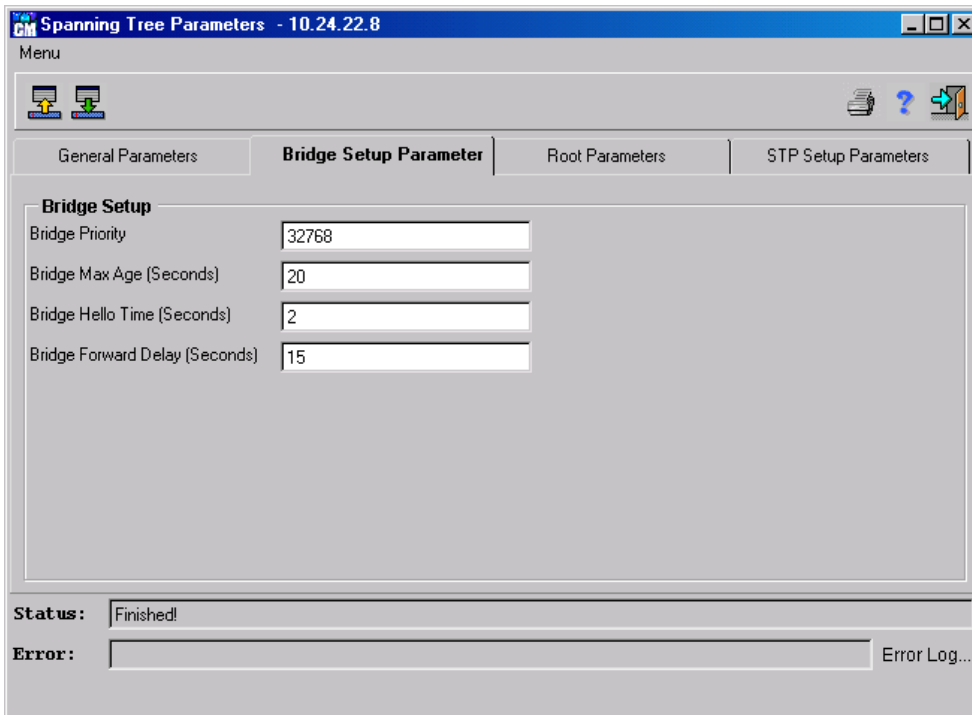

Figure 6- 71. Spanning Tree Parameters window Bridge Setup Parameter tab

The **Bridge Setup Parameter** tab displays the following fields:

- ◆ **Bridge Priority** – Identifies the bridge priority and is part of the bridge identifier. The bridge identifier is 8 octets long, and the two most significant octets indicate the bridge priority. The bridge with the lowest value is the root.
- ◆ **Bridge Max Age (Seconds)** – Indicates the amount of time a bridge waits before implementing a topological change. The possible values are 6-40 seconds. The default is 20 seconds. This parameter is configured on all the bridges participating in the STP, but only the one belonging to the elected Root Bridge is used. It is strongly recommended to use:

$$\text{Max age} \geq \text{Hello time} \times 2 + 1.0\text{s.}$$
- ◆ **Bridge Hello Time (Seconds)** – Indicates the amount of time a root bridge waits between configuration messages. The possible values are 1-10 seconds. The default is 2 seconds. Lengthening the Bridge Hello Time lowers the overhead time of the Spanning Tree Protocol (STP).
- ◆ **Bridge Forwarding Delay (Seconds)** – Indicates the amount of time a bridge remains in a *listening* and *learning* state before forwarding packets. The possible values are 4-30 seconds. Bridge Forward Delay is also used when a topology change is detected. Bridge Forward Delay ensures that Bridges use a consistent value for the Forward Delay Timer when changing the Port State to forwarding. The default is 15 seconds.

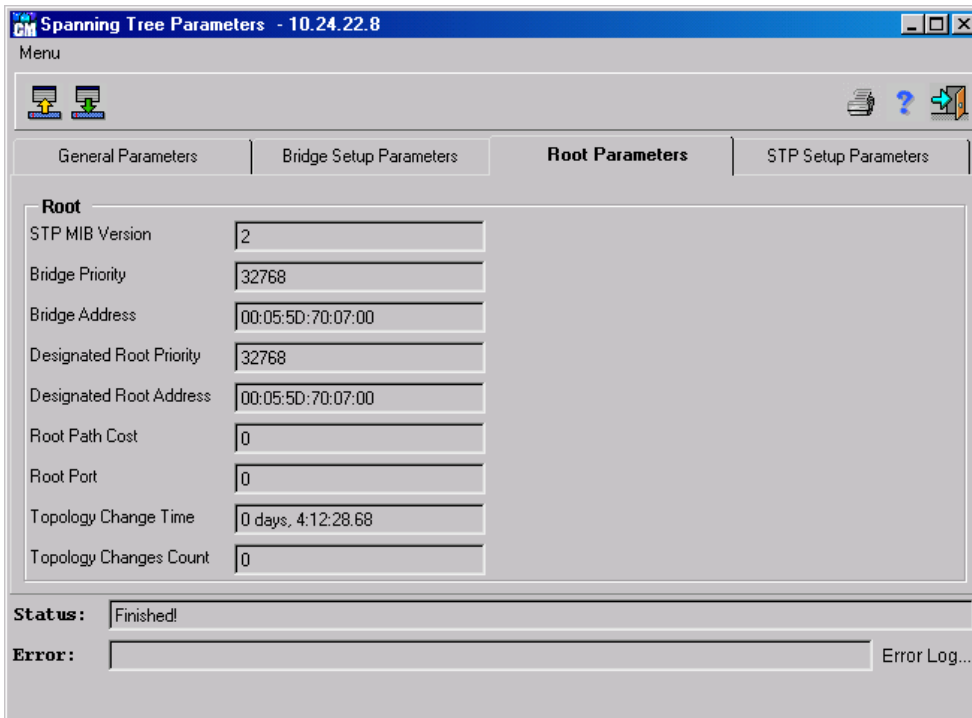

Figure 6- 72. Spanning Tree Parameters window Root Parameters tab

The **Root Parameters** tab displays the following fields:

- ◆ **STP MIB Version** – Indicates the MIB version currently in use.
- ◆ **Bridge Priority** – Indicates the bridge's priority within the Spanning Tree. The bridge with the lowest value has the highest priority, and is the *root*.
- ◆ **Bridge Address** – Specifies the MAC address of the bridge.
- ◆ **Designated Root Priority** – Indicates the root's priority.
- ◆ **Designated Root Address** – Specifies the root's MAC address.
- ◆ **Root Path Cost** – The cost of the path from this bridge to the root.
- ◆ **Root Port** – Indicates the port number that offers the lowest cost path from this bridge to the Root Bridge. It is significant when the Bridge is not the Root. The default is zero.
- ◆ **Topology Change Time** – Indicates the amount of time that has passed since the last topological change.
- ◆ **Topology Changes Count** – Indicates the total amount of topographic changes in since the bridge was initialized or reset. The time is displayed in an hour-minute-second format, for example, 5 hours 10 minutes and 4 seconds.

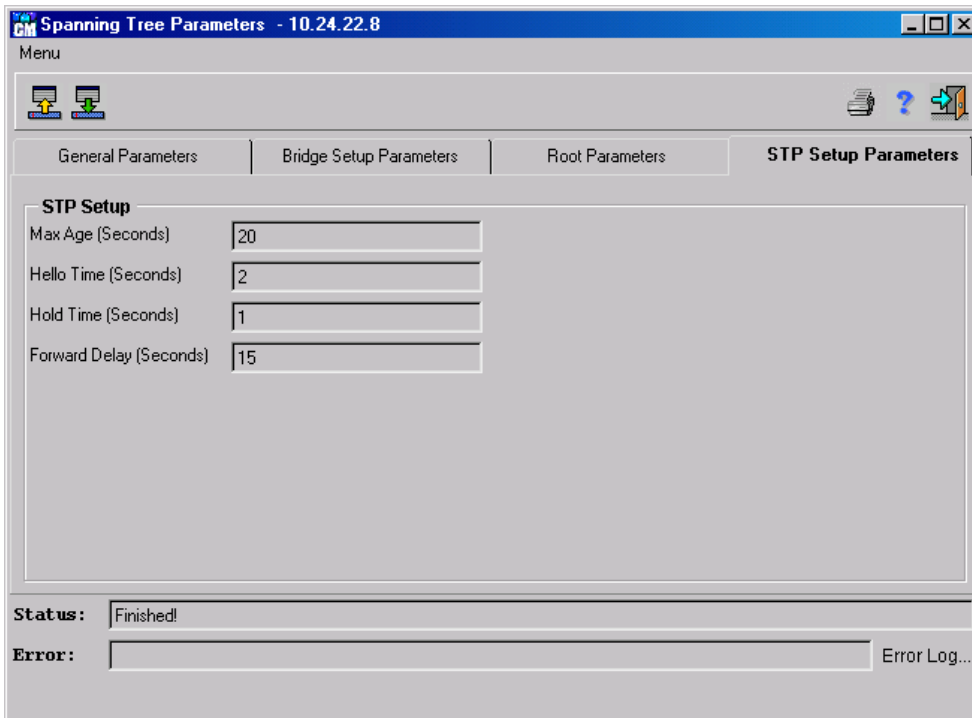

Figure 6- 73. Spanning Tree Parameters window STP Setup Parameters tab

The **STP Setup Parameters** tab displays the following fields:

- ◆ **MAX Age (Seconds)** – Indicates the amount of time in seconds that the bridge waits before discarding learned information. Identifies the timeout value used by all Bridges. This ensures that each Bridge has a consistent value against which to test the age of stored configuration information.
- ◆ **Hello Time (Seconds)** – Indicates the amount of time a bridge waits between CMs.
- ◆ **Hold Time (Seconds)** – Indicates the amount of time between the relaying of configuration messages through a port. The default value is 1 second.
- ◆ **Forward Delay (Seconds)** – Indicates the amount of time that a port remains in the listening and learning state before forwarding the traffic. This value is also used, when a topology change has been detected and is underway, to age all dynamic entries in the Forwarding Database. Forward Delay ensures that each Bridge uses a consistent value for the Forward Delay Timer when changing the State of a Port to the Forwarding State.

Note: *Forward Delay (Sec) in contrast to Bridge Forward Delay (Sec) is the value currently in use. Bridge Forward Delay (Sec), Bridge Max Age (Sec), and Bridge Hello Time (Sec) are the values that this bridge and all others use when the bridge becomes the root.*

Spanning Tree Port Table

The **Spanning Tree Port Table** allows network managers to edit the port states and parameters for the STP managed ports, and displays the port's current status.

To display the Spanning Tree Port Table:

- ◆ Select **Bridge > Spanning Tree > Spanning Tree Port Table**. The **Spanning Tree Port Table** opens:

Port	Priority	PortState	Port Enable	Path Cost	Designated Root	Designated Cost	Designated Bridge	Port Designated Port	Forward Transitions	
1	1-1	128	Disabled	Enabled	19	8000 00:05:5D:70:07:00	0	8000 00:05:5D:70:07:00	6-0	0
2	1-2	128	Disabled	Enabled	19	8000 00:05:5D:70:07:00	0	8000 00:05:5D:70:07:00	6-0	0
3	1-3	128	Disabled	Enabled	19	8000 00:05:5D:70:07:00	0	8000 00:05:5D:70:07:00	6-0	0
4	1-4	128	Disabled	Enabled	19	8000 00:05:5D:70:07:00	0	8000 00:05:5D:70:07:00	6-0	0
5	1-5	128	Disabled	Enabled	19	8000 00:05:5D:70:07:00	0	8000 00:05:5D:70:07:00	6-0	0
6	1-6	128	Disabled	Enabled	19	8000 00:05:5D:70:07:00	0	8000 00:05:5D:70:07:00	6-0	0
7	1-7	128	Disabled	Enabled	19	8000 00:05:5D:70:07:00	0	8000 00:05:5D:70:07:00	6-0	0
8	1-8	128	Disabled	Enabled	19	8000 00:05:5D:70:07:00	0	8000 00:05:5D:70:07:00	6-0	0
9	1-9	128	Disabled	Enabled	19	8000 00:05:5D:70:07:00	0	8000 00:05:5D:70:07:00	6-0	0

Number Of Entries In Table: 96

Status: Finished

Error: Error Log...

Figure 6- 74. Spanning Tree Port Table window

The **Spanning Tree Port Table** displays the following fields:

- ◆ **Port** – Indicates the port number to which the STP applies.
- ◆ **Priority** – Indicates the priority value of the port. The Priority value can be used to influence the choice of port when a bridge has two ports connected in a loop.
- ◆ **PortState** – Indicates the current STP state of a port. If enabled *Port State* determines what forwarding action is taken on traffic. If the bridge discovers a malfunctioning port, the port is placed in the *Broken State*. The possible values are:
 - ◇ Disabled – STP is currently disabled on the port. The port forwards traffic while *learning* MAC addresses.
 - ◇ Blocking – The port is currently blocked and cannot be used to forward traffic or learn MAC addresses.
 - ◇ Listening – The port is currently in the *listening* mode. The port cannot forward traffic nor can it learn MAC addresses.
 - ◇ Learning – The port is currently in the learning mode. The port cannot forward traffic however it can learn new MAC addresses.
 - ◇ Forwarding – The port is currently in the forwarding mode. The port can forward traffic and learn new MAC addresses.
 - ◇ Broken – The port is currently malfunctioning and cannot be used for forwarding traffic.
- ◆ **Port Enable** – Indicates if the STP is enabled on the port. If the port is disabled, the PortState is forwarding.
- ◆ **Path Cost** – The amount this port contributes to the Root Path Cost. The Path Cost can be adjustable to a higher or lower value, and can be used to forward traffic towards or away from a path being rerouted.
- ◆ **Designated Root** – The Designated Bridge transmits a unique Bridge Identifier as the *root* in the CMs.
- ◆ **Designated Cost** – The Designated Port path cost of network segments connected to this port. This value is compared to the Root Path Cost field in received CMs.
- ◆ **Designated Bridge** – Identifies which bridge is the designated bridge for the port.
- ◆ **Port Designated Port** – Identifies the port on the designated bridge.

- ◆ **Forward Transitions** – Indicates the number of times the port has gone from a learning state to a forwarding state.

To edit an entry in the Spanning Tree Port Table:



1. Display the **Spanning Tree Port Table**.
2. Double-click an entry in the **Spanning Tree Port Table**.

or

Click . The **Spanning Tree Port Table - Edit** window opens:

Port	1-1
Priority	128
PortState	Disabled
Port Enable	Enabled
Path Cost	19
Designated Root	8000 00:05:5D:70:07:00
Designated Cost	0
Designated Bridge	8000 00:05:5D:70:07:00
Port Designated Port	6-0
Forward Transitions	0

Figure 6-75. Spanning Tree Port Table- Edit window

1. Edit the fields. The fields are the same as the **Spanning Tree Port Table** as described above.
2. Click . The **Spanning Tree Port Table - Edit** window closes.
3. Click . When the Status field displays “Finished!”, the entry is saved to the device.

STP per VLAN

The following window applies to STP per device. STP can be implemented on a per VLAN basis.

Note: *STP per VLAN isn't supported in the present software release.*

Spanning Tree Parameters

The **Spanning Tree Parameters** window allows you to set the parameters for the Spanning Tree Mode.

To display the Spanning Tree Parameters window:

- ◆ Select **Bridge > Spanning Tree > Parameters**. The **Spanning Tree Parameters** window opens:

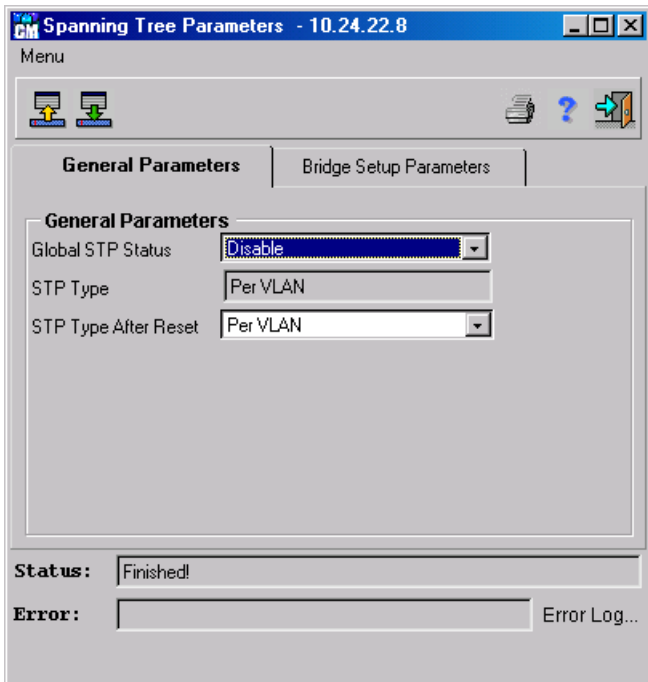

Figure 6- 76. Spanning Tree Parameters window General Parameters tab

The **General Parameters** tab displays the following fields:

- ◆ **Global STP Status** – Indicates the STP status. The possible values are:
 - ◇ Enable – STP is enabled.
 - ◇ Disable – STP is disabled.
- ◆ **STP Type** – Indicates if the STP mode is per device or per VLAN.
- ◆ **STP Type After Reset** – Indicates the STP setting after the device is reset. The possible values are:
 - ◇ Per Device – Indicates that the STP mode is per device.
 - ◇ Per VLAN – Indicates that the STP mode is per VLAN.

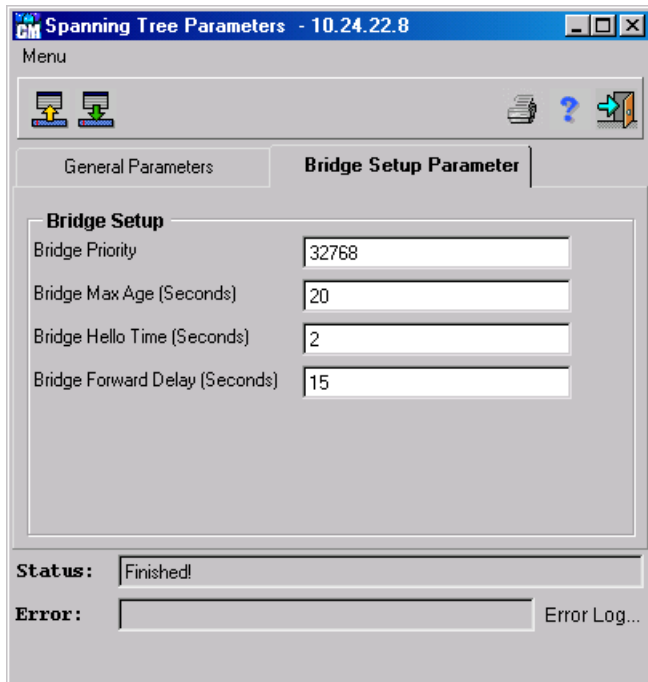

Figure 6- 77. Spanning Tree Parameters window Bridge Setup Parameter tab

The **Bridge Setup Parameter** tab displays the following fields:

- ◆ **Bridge Priority** – Indicates the bridge’s priority within the Spanning Tree. The bridge with the lowest value has the highest priority, and is the root.
- ◆ **Bridge Max Age (Seconds)** – Indicates the amount of time a bridge waits before implementing a topological change. The possible values are 6-40 seconds. The default is 20 seconds. This parameter is configured on all the bridges participating in the STP but only the one belonging to the elected Root Bridge is used. It is strongly recommended to use:

$$\text{Max age} \geq \text{Hello time} \times 2 + 1.0\text{s.}$$

- ◆ **Bridge Hello Time (Seconds)** – Indicates the amount of time a root bridge waits between configuration messages. The possible values are 1-10 seconds. The default is 2 seconds. Lengthening the Bridge Hello Time lowers the overhead time of the Spanning Tree Protocol (STP).
- ◆ **Bridge Forward Delay (Seconds)** – Indicates the amount of time a bridge remains in a listening and learning state before forwarding packets. The possible values are 4-30 seconds. Bridge Forward Delay is also used when a topology change is detected. Bridge Forward Delay ensures that Bridges use a consistent value for the Forward Delay Timer when changing the State of a Port to the forwarding state. The default is 15 seconds.

Spanning Tree Extended Port Table

The **Spanning Tree Extended Port Table** displays various types of damp and BPDU information.

To display the Spanning Tree Extended Port Table:

- ◆ Select **Bridge > Spanning Tree > Spanning Tree Extended Port Table**. The **Spanning Tree Extended Port Table** opens:

	Port	Damp Enable	Damp Stable	Filter BPDU	BPDU Sent	BPDU Received
1	1-1	false	false	false	0	0
2	1-2	false	false	false	0	0
3	1-3	false	false	false	0	0
4	1-4	false	false	false	0	0
5	1-5	false	false	false	0	0
6	1-6	false	false	false	0	0
7	1-7	false	false	false	0	0
8	1-8	false	false	false	0	0
9	1-9	false	false	false	0	0
10	1-10	false	false	false	0	0

Number Of Entries In Table: 96

Status: Finished!

Error: Error Log...

Figure 6- 78. Spanning Tree Extended Port Table window

The **Spanning Tree Extended Port Table** displays the following fields:

- ◆ **Damp Enable** – Indicates Damp Enable status.
- ◆ **Damp Stable** – Indicates Damp Stable status.
- ◆ **Filter BPDU** – Indicates whether Bridge Protocol Data Units are being filtered by the switch.
- ◆ **BPDU Sent** – The number of Bridge Protocol Data Units sent from the port.
- ◆ **BPDU Received** – The number of Bridge Protocol Data Units received on the port.

Rapid Spanning Tree

Rapid STP provides a faster re-configuration of network paths than regular STP. Bridges make their forwarding assessments on both STP and Rapid STP paths.

The **Rapid Spanning Tree** menu option has the following menu options:

- ◆ Ports Table.
- ◆ Force Version Table.

Rapid STP Port Table

The **Rapid STP Port Table** contains information about the STP state on ports and VLANs.

To display the Rapid STP Port Table:

- ◆ Select **Bridge > Rapid Spanning Tree > Ports Table**. The **Rapid STP Port Table** opens:

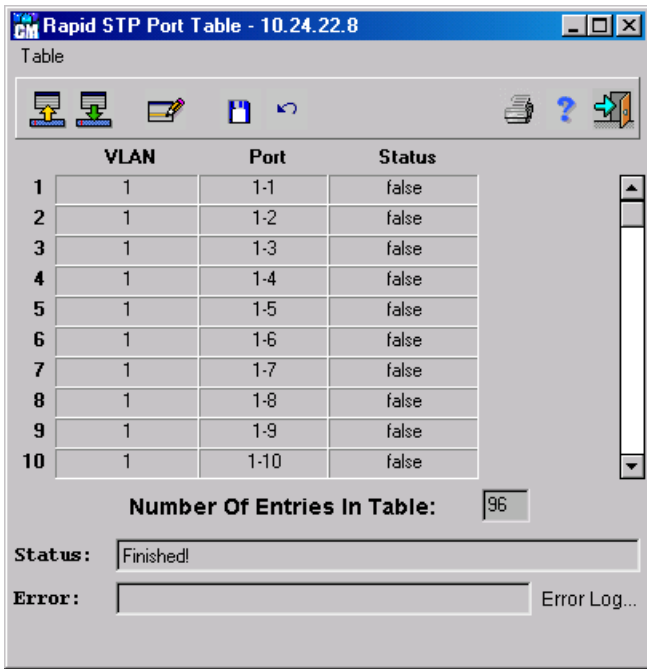

Figure 6- 79. Rapid STP Port Table window

The **Rapid STP Port Table** displays the following fields:

- ◆ **VLAN** – Identifies the VLAN to which the port belongs and STP is enabled.
- ◆ **Port** – Identifies the port number for which STP is currently enabled.
- ◆ **Status** – Indicates if the port is an edge port. The default is false.

Note: *Rapid STP is recommended for edge ports in the topology. This eliminates loops that may be created through these ports.*

To edit an entry in the Rapid STP Port Table:

1. Display the **Rapid STP Port Table**.
2. Double-click an entry in the **Rapid STP Port Table**.

or

Click . The **Rapid STP Port Table - Edit** window opens:

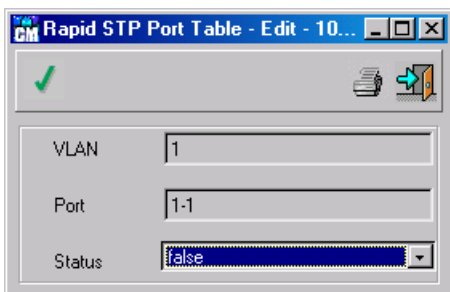



Figure 6- 80. Rapid STP Port Table – Edit window

3. Edit the fields. The fields are the same as the **Rapid STP Port Table** as described above.
4. Click . The **Rapid STP Port Table - Edit** window closes.

5. Click . When the Status field displays “Finished!”, the entry is saved to the device.

Rapid STP Force Version Table

The **Rapid STP Force Version Table** contains information specific to Rapid STP.

To display the Rapid STP Force Version Table:

- ◆ Select **Bridge > Rapid Spanning Tree > Force Version Table**. The **Rapid STP Force Version Table** opens:

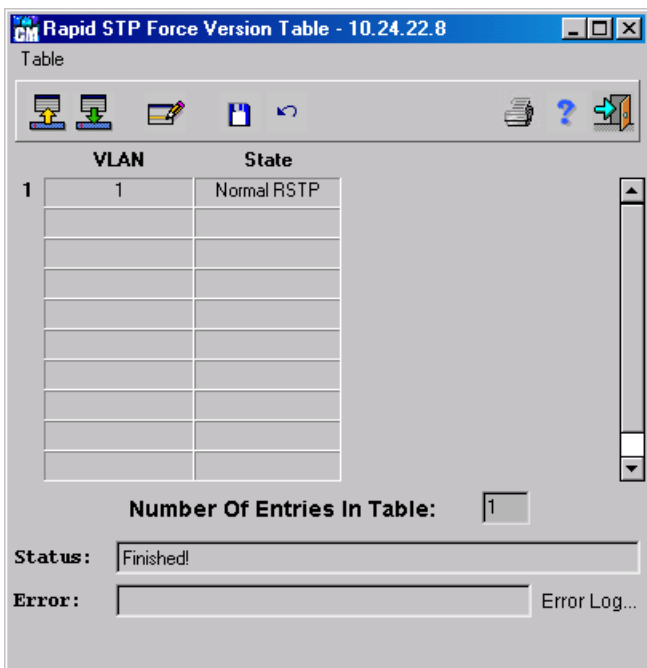

Figure 6- 81. Rapid STP Force Version Table window

The **Rapid STP Force Version Table** displays the following:

- ◆ **VLAN** – The VLAN number to which the VLAN belongs.
- ◆ **State** – Specifies if the bridge is currently using:
 - ◇ Normal RSTP – Rapid STP Bridge Protocol Data Units (BPDU) are transmitted unless a legacy system is detected by a port.
 - ◇ STP Compatibility – Indicates the rapid transition of alternate ports to root ports. Rapid STP transmits the configuration BPDUs and the Topology Change Notification (TCN) BPDUs only. Rapid STP BPDUs are discarded.

To edit an entry in the Rapid STP Force Version Table:

1. Display the **Rapid STP Force Version Table**.
2. Double-click an entry in the **Rapid STP Force Version Table**.

or

Click . The **RSTp Force Version Table - Edit** window opens:

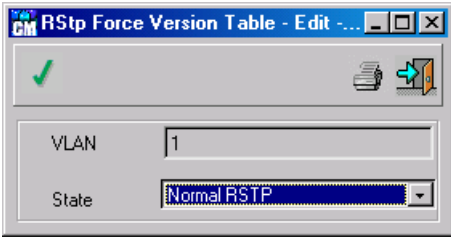

Figure 6- 82. RStp Force Version Table – Edit window

3. Edit the fields. The fields are the same as the **Rapid STP Force Version Table** as described above.
4. Click . The **RStp Force Version Table - Edit** window closes.
5. Click . When the Status field displays “Finished!”, the entry is saved to the device.

Traffic Control

Traffic control allows users to map network traffic to priority queues, which determine the forwarding of network traffic. Priority values are assigned per port, and the settings are assigned per queue.

The **Traffic Control** menu option has the following menu options:

- ◆ Port Priority Table.
- ◆ Traffic Class Table.
- ◆ Priority Groups Table.

Traffic Control Port Priority Table

To display the Traffic Control Port Priority Table:

- ◆ Select **Bridge > Traffic Control > Port Priority Table**. The **Port Priority Table** opens:

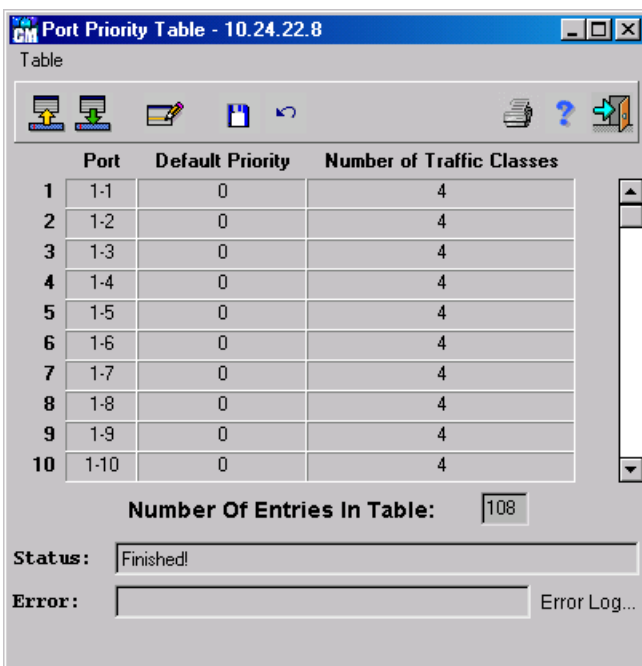

Figure 6- 83. Port Priority Table window

The **Traffic Control Port Priority Table** displays the following fields:

- ◆ **Port** – Identifies the port on the device.
- ◆ **Default Priority** – Indicates the default user priority assigned to the ingress port. Ports may have a priority value of 0-7. The default value is 0. Packets are assigned the default port priority if they are not tagged. Tagged packets are forwarded with their tagged priority.
- ◆ **Number of Traffic Classes** – The number of traffic classes to which received packets can be mapped. Priorities are mapped as follows:
 - ◇ Priorities 2-1 – Mapped to traffic class 0. Traffic class 0 is the lowest priority for forwarding packets.
 - ◇ Priorities 0-3 – Mapped to traffic class 1.
 - ◇ Priorities 4-5 – Mapped to traffic class 2.
 - ◇ Priorities 6-7 – Mapped to traffic class 3. Traffic class 3 is the highest priority for forwarding packets.

To edit an Traffic Control Port Priority Table entry:

1. Display the **Port Priority Table**.
2. Double-click an entry in the **Port Priority Table**.

or

Click . The **Port Priority Table - Edit** window opens:

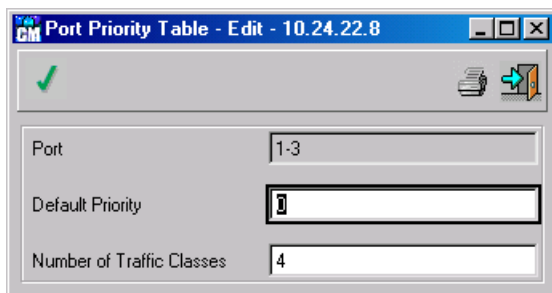



Figure 6- 84. Port Priority Table – Edit window

3. Edit the fields. The fields are the same as the **Port Priority Table** as described above.
4. Click . The **Port Priority Table - Edit** window closes.
5. Click . When the Status field displays “Finished!”, the entry is saved to the device.

Traffic Class Table

The **Traffic Class Table** allows network managers to map packet priorities to traffic classes within a group. Traffic class groups can only be configured on the same Hertz. Priorities can be mapped to four traffic classes.

To display the Traffic Class Table:

- ◆ Select **Bridge > Traffic Control > Traffic Class Table**. The **Traffic Class Table** opens:

	Port	Port Group	P0	P1	P2	P3	P4	P5	P6	P7
1	1-1	2	1	0	0	1	2	2	3	3
2	1-2	2	1	0	0	1	2	2	3	3
3	1-3	2	1	0	0	1	2	2	3	3
4	1-4	2	1	0	0	1	2	2	3	3
5	1-5	2	1	0	0	1	2	2	3	3
6	1-6	2	1	0	0	1	2	2	3	3
7	1-7	2	1	0	0	1	2	2	3	3
8	1-8	2	1	0	0	1	2	2	3	3
9	1-9	1	1	0	0	1	2	2	3	3
10	1-10	1	1	0	0	1	2	2	3	3

Number Of Entries In Table:

Status:

Error: Error Log...

Figure 6-85. Traffic Class Table window

The **Traffic Class Table** displays the following fields:

- ◆ **Port** – Indicates the port number.
- ◆ **Port Group** – Indicates the group to which a port belongs. All ports in a group must be mapped to the same priority and traffic class.
- ◆ **P0** – Indicates the traffic class value to which priority 0 is mapped.
- ◆ **P1** – Indicates the traffic class value to which priority 1 is mapped.
- ◆ **P2** – Indicates the traffic class value to which priority 2 is mapped.
- ◆ **P3** – Indicates the traffic class value to which priority 3 is mapped.
- ◆ **P4** – Indicates the traffic class value to which priority 4 is mapped.
- ◆ **P5** – Indicates the traffic class value to which priority 5 is mapped.
- ◆ **P6** – Indicates the traffic class value to which priority 6 is mapped.
- ◆ **P7** – Indicates the traffic class value to which priority 7 is mapped.

To edit the Traffic Class Table:

1. Display the **Traffic Class Table**.
2. Double-click an entry in the **Traffic Class Table**.

or

Click . The **Traffic Class Table- Edit** window opens:

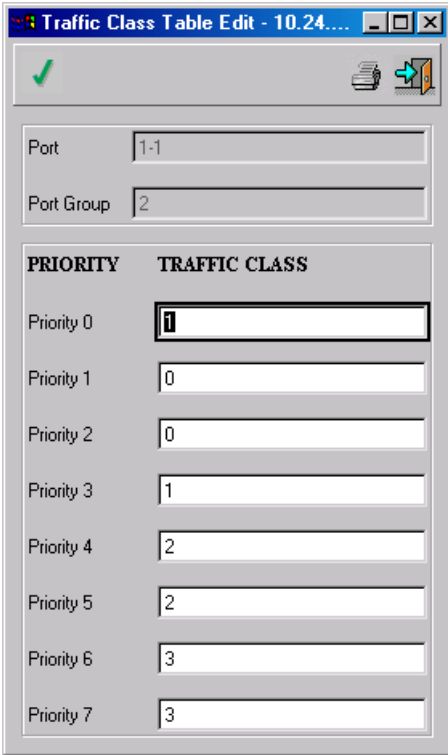



Figure 6- 86. Traffic Class Table Edit window

3. Edit the fields. The fields are the same as the **Traffic Class Table** as described above.
4. Click . The **Traffic Class Table Edit** window closes.
5. Click . When the Status field displays “Finished!”, the entry is saved to the device.

Priority Group Table

The **Priority Groups Table** contains information about a port’s priority group.

To display the Priority Groups Table:

- ◆ Select **Bridge > Traffic Control > Priority Groups Table**.

The **Priority Groups Table** opens:

	Port	Priority Group
1	1-1	2
2	1-2	2
3	1-3	2
4	1-4	2
5	1-5	2
6	1-6	2
7	1-7	2
8	1-8	2
9	1-9	1
10	1-10	1

Number Of Entries In Table:

Status:

Error: Error Log...

Figure 6-87. Priority Groups Table window

The **Priority Groups Table** displays the following fields:

- ◆ **Port** – Indicates the port number.
- ◆ **Priority Group** – Indicates the group to which a port belongs.

Configuring Routing

This section describes the Router menu and its options, including routing settings for IP, IPM, and IPX routing

IP

For a device to perform IP routing, an IP Interface is configured. The IP interface consist of two parts:

- ◆ **IP Address** – The IP Address is defined for a physical port or VLAN.
- ◆ **IP Network Mask** – The IP Network Mask is determined by the network setup.

A device performs IP routing between all defined IP interfaces. The **IP** menu option has the following menu options:

- ◆ Operating Parameters
- ◆ Interface Parameters
- ◆ RIP
- ◆ OSPF II
- ◆ Routing Table
- ◆ ARP Table
- ◆ IP Redundancy
- ◆ DHCP

- ◆ UDP Relay
- ◆ TCP General Parameters
- ◆ TCP Connections Table

Operating Parameters

The **Operating Parameters** window contains information about how the IP Router operates.

To display the IP Operating Parameters window:

- ◆ Select **Router > IP > Operating Parameters**. The **IP Router Operating Parameters** window opens:

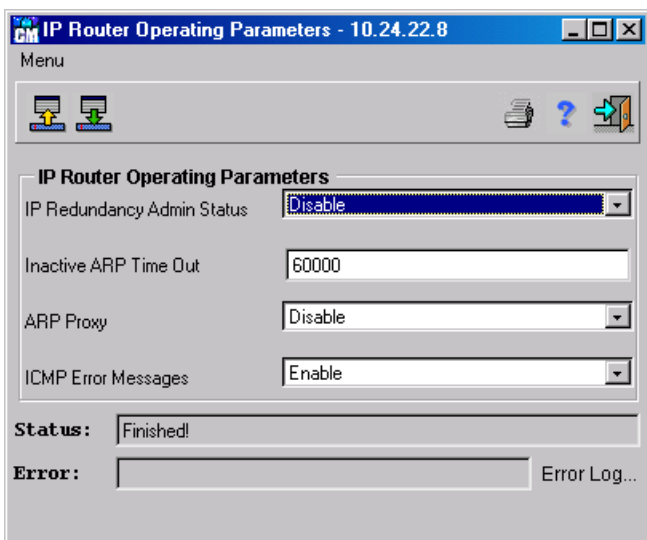



Figure 6- 88. IP Router Operating Parameters window

The **IP Router Operating Parameter** window displays the following fields:

- ◆ **IP Redundancy Admin Status** – If enabled, this device serves as a backup if the current main device fails.
- ◆ **Inactive ARP Time Out** – Seconds passed between ARP requests about an entry in the ARP table. After this period, the entry is deleted from the table.
- ◆ **ARP Proxy** – If enabled, the device responds to ARP requests for located nodes. If disabled the device responds with its own MAC address.
- ◆ **ICMP Error Messages** – If enabled the device generates ICMP error messages.

To edit IP Router operating parameter fields:

1. Display the **IP Router Operating Parameters** window.
2. Edit the fields as required.
3. Click . When the Status field displays “Finished!”, the fields are confirmed as modified.

Interface Parameters

The **Interface Parameters** window displays specific details for each interface including IP addresses, network masks, port index number, broadcast types and if the ARP server is enabled.

To display a device IP Router Interfaces:

- ◆ Select **Router > IP > Interface Parameters**. The **IP Router Interface Parameters** window opens:

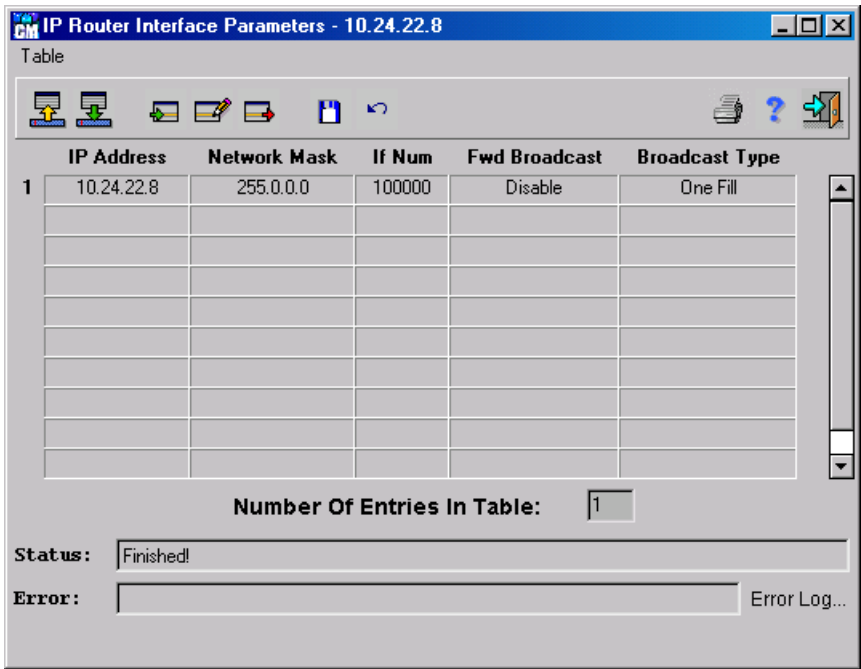



Figure 6- 89. IP Router Interface Parameters window

The **IP Router Interface Parameters** window displays the following details for all a device IP interfaces:

- ◆ **IP Address** – Interface IP address.
- ◆ **Network Mask** – Associated subnet mask.
- ◆ **If Num** – Interface number. If the interface is a VLAN, the included interfaces are listed in the Interface Number box in the **IP Router Interface Parameters Insert** window.
- ◆ **Fwd Broadcast** – Indicates if the device forwards incoming broadcasts to this interface.
- ◆ **Broadcast Type** – Fills the host ID in the broadcast address with ones or zeros.

To add new a device IP interface:

1. Display the **IP Router Interface Parameters** window.
2. Click  to add an IP interface. The **IP Router Interface Parameters Insert** window opens:

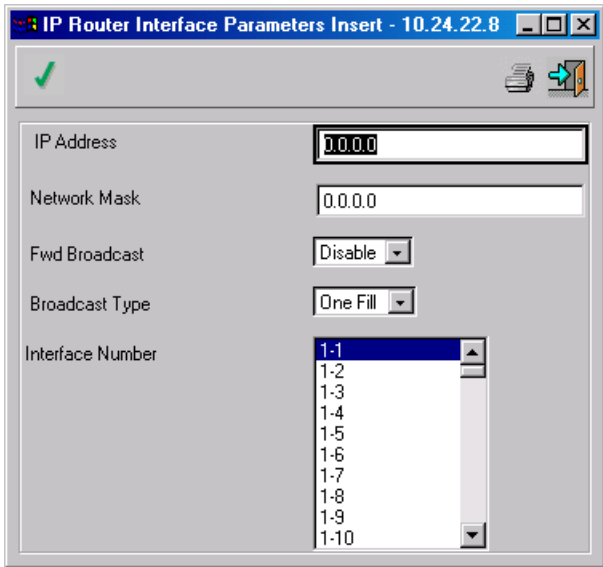



Figure 6- 90. IP Router Interface Parameters Insert window

3. Enter the IP Address and Network Mask as determined by the network setup.
4. Select an interface number from the Interface Number list. This list contains all physical interfaces and all IP VLANs. If a required physical interface combination is not listed, use the **VLAN Table** to define the desired combination.
5. Click  to confirm the new IP Interface.
6. Repeat steps 2-5 for all new IP interfaces.

To edit a a device IP interface:

1. Display the **IP Router Interface Parameters** window.
2. Select an entry and click . **The IP Router Interface Parameters Edit** window opens:

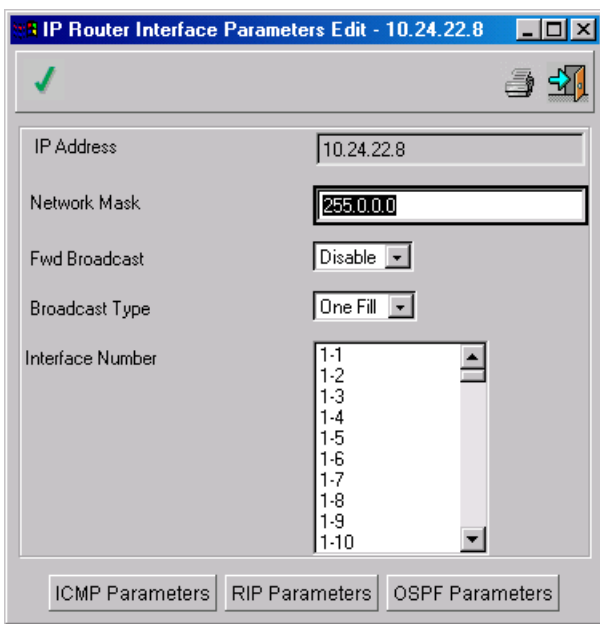



Figure 6-91. IP Router Interface Parameters Edit window



The **IP Router Interface Parameters Edit** window contains the following buttons that define additional parameters:

- ◆ **ICMP Parameters** – Defines the ICMP parameters for IP interface.
- ◆ **RIP Parameters** – Defines the RIP parameters for IP interface.
- ◆ **OSPF Parameters** – Defines the OSPF parameters for IP interface

1. Edit the fields required, except the IP Address field.
2. Press the **ICMP Parameters** button and complete the **ICMP Interface Parameters** window fields.
3. Press the **RIP Parameters** button and complete the **RIP Interface Table Edit** window fields.
4. Press the **OSPF Parameters** button and complete the **OSPF Interface table** fields.
5. Click  to confirm the new IP Interface.
6. Close the **IP Router Interface Parameters Edit** window.

To delete a a device IP interface:

1. Display the **IP Router Interface Parameters** window.
2. Select an entry in the table.

3. Click . The IP Address is deleted.
4. Click  to update the device.

To display the ICMP Interface Parameters window:

1. Display the **IP Router Interface Parameters Edit** window.
2. Press the **ICMP Parameters** button. The **ICMP Interface Parameters** window opens:

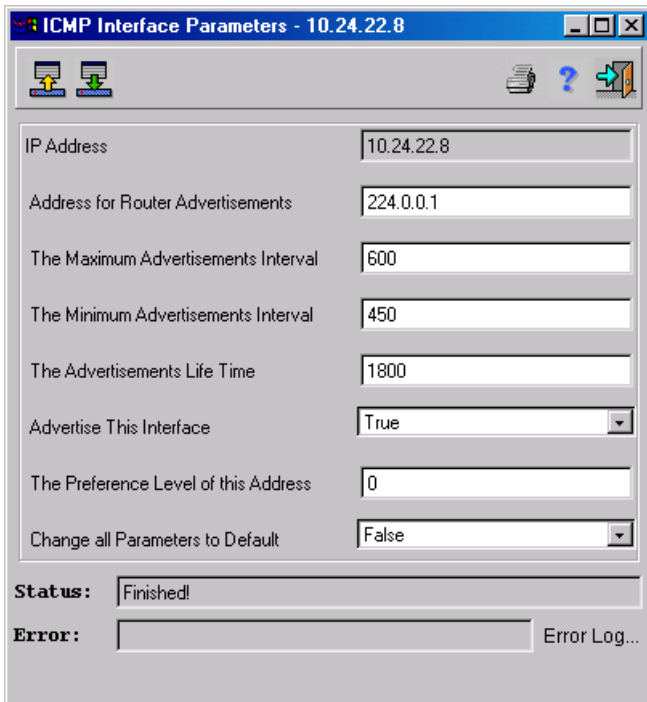



Figure 6-92. ICMP Interface Parameters window

The **ICMP Interface Parameters** window displays the following fields:

- ◆ **IP Address** – Interface IP address.
- ◆ **Address for Router Advertisements** – IP destination address for multicast Router Advertisements sent from the interface. Possible values are the all-systems multicast address, 224.0.0.1, or the limited-broadcast address, 255.255.255.255.
- ◆ **The Maximum Advertisements Interval** – Maximum time in seconds between multicast Router Advertisements from the interface. Possible values are between the minimum interval defined below and 1800 seconds.
- ◆ **The Minimum Advertisements Interval** – Minimum time in seconds between sending unsolicited multicast Router Advertisements from the interface. Possible values are between 3 seconds and the maximum interval defined above. Default value is 0.75 of the Maximum Interval.
- ◆ **The Advertisements Lifetime** – Maximum time in seconds the advertised addresses are considered valid. Must be no less than a Maximum Interval defined above, and no greater than 9000 seconds. Default value is 0.3 of the Maximum Interval.
- ◆ **Advertise This Interface** – Whether the address is advertised.
- ◆ **The Preference Level of this Address** – Preference address as a default router Default address, relative to other router addresses on the same Subnet.
- ◆ **Change all Parameters to Default** – Resets all parameters in this window to their default values.

To edit ICMP Interface Parameters fields:

1. Display the **ICMP Interface Parameters** window.
2. Edit any field except the IP Address field.
3. Click . When the Status field displays “Finished!”, the fields are confirmed as modified.

To display the RIP Interface Table Edit window:

1. Display the **IP Router Interface Parameters Edit** window.
2. Press the **RIP Parameters** button. The **RIP Interface Table Edit** window opens:

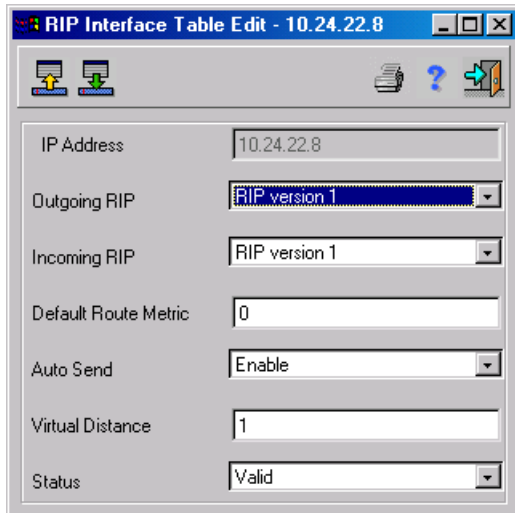



Figure 6-93. RIP Interface Table Edit window

The **RIP Interface Table Edit** window displays the following fields:

- ◆ **IP Address** – The IP address of the current interface.
- ◆ **Outgoing RIP** – The type of RIP being sent.
 - ◇ RIP version 1 – Sending RIP updates compliant with RFC 1058.
 - ◇ RIP version 2 – Multicasting RIP-2 updates.
 - ◇ Do Not Send – No RIP updates are sent.
- ◆ **Incoming RIP** – The type of RIP being received.
 - ◇ RIP version 1 – Accepting RIP 1.
 - ◇ RIP version 2 – Accepting RIP 2.
 - ◇ Do Not Receive – No RIP updates are accepted.
- ◆ **Default Route Metric** – Metric for the default route entry in RIP updates originated on this interface. Zero indicates that no default route should be originated.
- ◆ **Auto Send** – When this parameter is enabled, the device advertises RIP messages with only the default metric. This allows some stations to learn the default router address. If the device detects another RIP message, Auto Send is disabled. Enable this to minimize network traffic when the device is the only router on the network.
- ◆ **Virtual Distance** – Virtual number of hops assigned to the interface. This enables RIP routing algorithm fine-tuning.
- ◆ **Status** – The status of the RIP in the router.

To edit RIP Parameters window fields:

1. Display the **RIP Interface Table** (Select **Router > IP > RIP > Interface Parameters**).
2. Select an entry in the table.
3. Click . The **RIP Interface Table Edit** window opens:

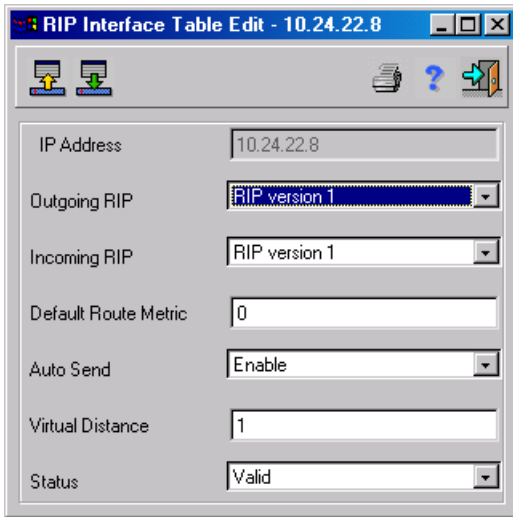

Figure 6- 94. RIP Interface Table Edit window

The **RIP Interface Table Edit** window fields are described above.

4. Edit the selected table entry fields and click . The **RIP Interface Table** opens.
5. Click . When the Status field displays “Finished!”, the fields are confirmed as modified.

To display the OSPF Interface Table Edit window:

OSPF is supported from software version 3.03 and up.

1. Display the **IP Router Interface Parameters Edit** window.
2. Press the **OSPF Parameters** button. The **OSPF Interface Table Edit** window opens:

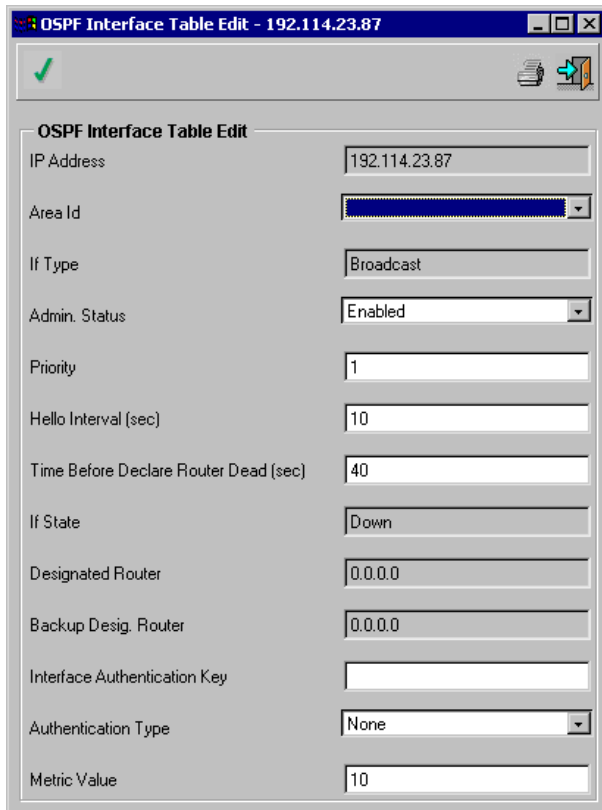





Figure 6-95. OSPF Interface Table Edit window

The **OSPF Interface Table Edit** window displays the following fields:

- ◆ **IP Address** – The IP address of this OSPF interface.
- ◆ **Area ID** – The IP address of the area.
- ◆ **If Type** – The interface type, such as Broadcast.
- ◆ **Admin. Status** – The administrative status of the OSPF in the router. Enabled means that the OSPF process is active on at least one interface. Disabled means the process is not active on any interface.
- ◆ **Priority** – The priority of this interface. The value 0 means that this router is not eligible to become the designated router on the current network. If more than one router has the same priority, the router ID is used.
- ◆ **Hello Interval (sec)** – The amount of seconds between Hello packets. All routers attached to a common network must have the same Hello Interval.
- ◆ **Time Before Declare Router Dead (sec)** – The number of seconds a router's Hello packets have not been detected, before the router's neighbors declare the router to be down. The value must be multiple of the Hello Interval value. All routers attached to a common network must have a value specified for this parameter.
- ◆ **If State** – The OSPF interface state:
 - ◇ Down – The OSPF interface is down.
 - ◇ Loopback – The OSPF interface is in the Loopback state.
 - ◇ Waiting – The OSPF interface is currently waiting.
 - ◇ Point to Point – The OSPF interface is in the point-to-point state.
 - ◇ Designated Router – The OSPF interface is the designated router.

- ◇ Backup Designated Router – The OSPF interface is the backup designated router.
- ◇ Other Designated Router – Other routers are the designated and backup routers.
- ◆ **Designated Router** – The IP address of the designated router.
- ◆ **Backup Desig. Router** – The IP address of the backup designated router.
- ◆ **Interface Authentication Key** – The interface authentication key.
- ◆ **Authentication Type** – The interface authentication type. The options are *None* or *Password*.
- ◆ **Metric Value** – The metric for this type of service on the interface.

To edit OSPF Parameter fields:

1. Display the **OSPF Interface Table**.
2. Select an entry in the table.
3. Click . The **OSPF Interface Table Edit** window opens.
4. Edit the selected table entry fields and click . The **OSPF Interface Table** opens.
5. Click . When the Status field displays “Finished!”, the fields are confirmed as modified.

RIP

The **RIP** menu has the following menu options:

- ◆ Parameters.
- ◆ Interface Parameters.
- ◆ RIP Filter.

Parameters

To display RIP Parameters:

- ◆ Select **Router > IP > RIP > Parameters**. The **RIP Parameters** window opens:

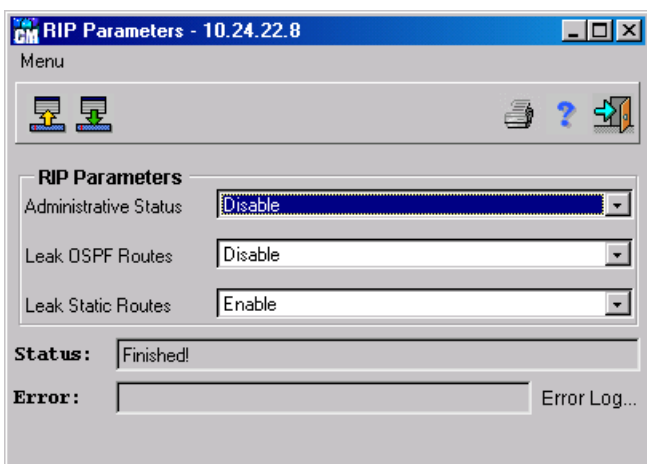



Figure 6- 96. RIP Parameters window

The **RIP Parameters** window displays the following:

- ◆ **Administrative Status** – The RIP administrative status in the router. Enabled means the RIP process is active on at least one interface. Disabled means the process is not active on any interfaces

- ◆ **Leak OSPF Routes** – Controls redistribution of routes from OSPF to RIP. When this parameter is enabled, all routes learned via OSPF are advertised into RIP.
- ◆ **Leak Static Routes** – Controls redistribution of routes from static routes to RIP. When this parameter is enabled, all static routes learned via static are advertised into RIP.

To edit RIP Parameter fields:

1. Display the **RIP Parameters** window.
2. Edit fields to *Enable* or *Disable*.
3. Click . When the Status field displays “Finished!”, the fields are confirmed as modified.

RIP Interface Parameters

To display the RIP Interface Table:

- ◆ Select **Router > IP > RIP > Interface Parameters**. The **RIP Interface Table** opens:

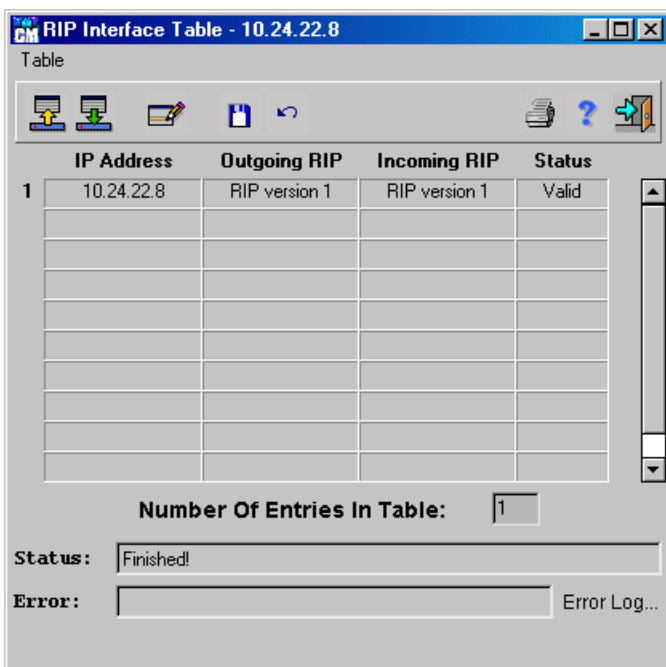



Figure 6- 97. RIP Interface Table window

The **RIP Interface Table** displays the following fields:

- ◆ **IP Address** – Current IP address interfaces.
- ◆ **Outgoing RIP** – The type of RIP being sent.
 - ◇ RIP Software version 1 – Sending RIP updates compliant with RFC 1058.
 - ◇ RIP Software version 2 – Multicasting RIP2 updates.
 - ◇ Do Not Send – No RIP updates are sent.
- ◆ **Incoming RIP** – The type of RIP being received.
 - ◇ RIP Software version 1 – Accepting RIP1.
 - ◇ RIP Software version 2 – Accepting RIP2.
- ◆ **Do Not Receive** – No RIP updates are accepted.
- ◆ **Status** – The RIP status in the router is either valid or invalid.

To edit RIP Interface Table fields:

1. Display the **RIP Interface Table**.
2. Select an entry in the table.
3. Click . The **RIP Interface Table Edit** window opens:

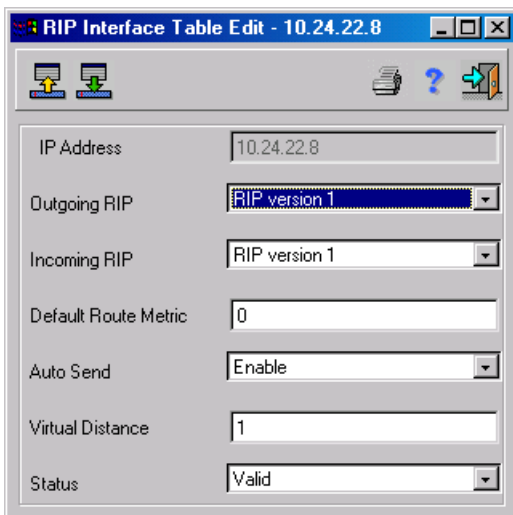



Figure 6- 98. RIP Interface Table Edit window

The **RIP Interface Table Edit** window display the following fields:

- ◆ **Default Route Metric** – Metric for the default route entry in RIP updates originated on this interface. Zero indicates that no default route is originated.
- ◆ **Auto Send** – When this parameter is enabled, this device advertises RIP messages in the default metric only. This allows some stations to learn the default router address. If the device detects another RIP message, Auto Send is disabled. Enable this parameter to minimize network traffic when the device is the only router on the network.
- ◆ **Virtual Distance** – Virtual number of hops assigned to the interface. This fine-tunes the RIP routing algorithm.

4. Edit the required fields. The IP Address field cannot be modified.
5. Click .
6. Close the **RIP Interface Table Edit** window. The **RIP Interface Table** opens.
7. Click . When the Status field displays “Finished!”, the fields are confirmed as modified.

RIP Filters

IP RIP filtering is a device feature that improves aggregate routing performance. Defining IP RIP filters reduces the RIP table size to the relevant IP subnets, allowing for a faster table lookup and relearning memory for other purposes. RIP filters are supported from software version 3.03 and up.

To display the RIP filters:

- ◆ Select **Router > IP > RIP > RIP Filters**. The **IP RIP Filter** window opens:

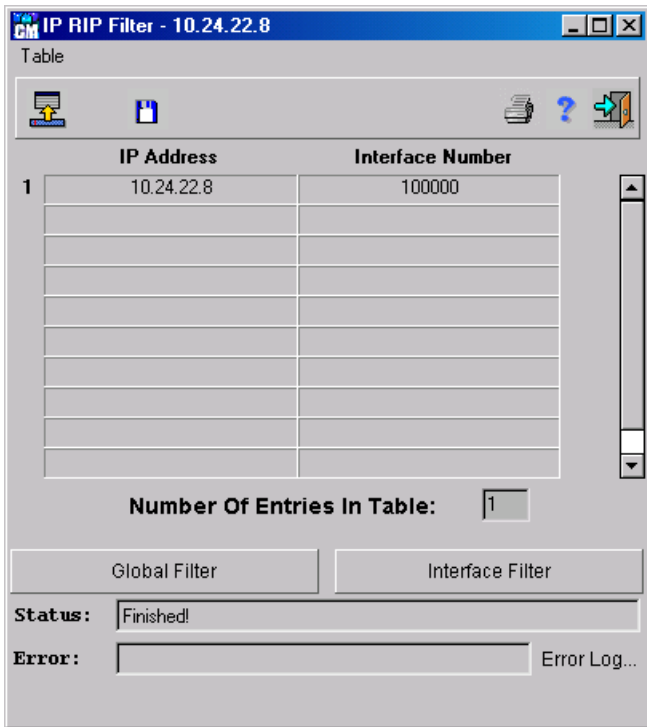

Figure 6- 99. IP RIP Filter window

The **IP RIP Filter** window displays the following fields:

- ◆ **IP Address** – The Interface IP address.
- ◆ **Interface Number** – The pre-assigned Interface number.

There are two added filters:

- ◆ **IP RIP Global Filter** – Defines the parameters for IP RIP Global Filters including the type, network address, bits matched, and filter actions.
- ◆ **IP Interface RIP Filter** – Defines the parameters for IP Interface RIP Filters including the type, validity, network address, bits matched, and filter actions.

To display IP RIP Global Filter Table:

1. Display the **IP RIP Filter** window.
2. Click **Global Filter**. The **IP RIP Global Filter Table** opens:

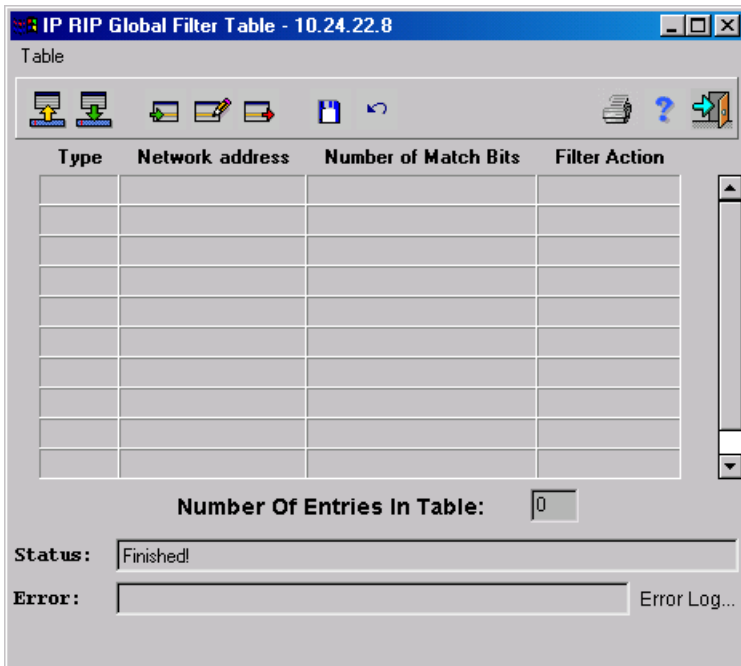

Figure 6- 100. IP RIP Global Filter Table window

The **IP RIP Global Filter Table** displays the following fields:

- ◆ **Type** – The filters type is for input or output transmissions.
- ◆ **Network Address** – The selected interface IP address
- ◆ **Number of Match Bits** – The number of bits to match the network IP address. A value less than 32 represents a wildcard.
- ◆ **Filter Action** – This parameter is used to fine-tune other filters. For example set a filter to block all RIPS messages with net address 192.114 and set another filter entry to permit all RIP messages with the network 192.114.25. All RIP messages with the network 192.114 that do not end in 25 are blocked.
 - ◇ Permit – Whether the indicated packets should be forwarded.
 - ◇ Deny – Whether the indicated packets should be blocked.

To add a global RIP filter:

1. Display the **IP RIP Global Filter Table**.
2. Click . The **IP RIP Filter Global Insert** window opens:

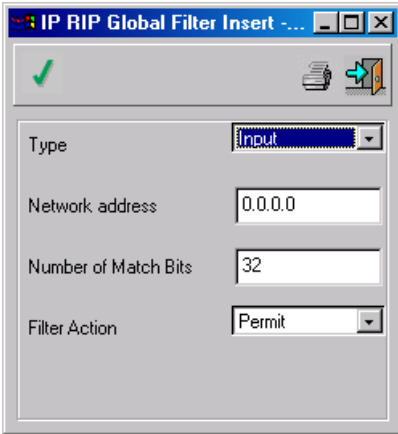





Figure 6- 101. IP RIP Global Filter Insert window

3. Complete the fields.
4. Click .
5. Close the **RIP Global Filter Insert** window. The **IP RIP Global Filter Table** opens.
6. Click . When the **Status** field displays “Finished!”, the fields are confirmed as modified.

To edit a global RIP filter:

1. Display the **IP RIP Global Filter Table**.
2. Select an entry in the table.
3. Click . The **RIP Global Filter Edit** window opens:

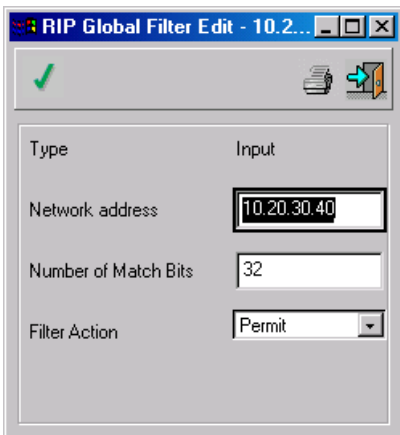





Figure 6- 102. RIP Global Filter Edit window

The **RIP Global Filter Edit** window is identical to the **RIP Global Filter Insert** window.

4. Modify the required fields.
5. Click .
6. Close the **RIP Global Filter Edit** window. The **IP RIP Global Filter Table** opens.
7. Click . When the Status field displays “Finished!”, the fields are confirmed as modified.

To delete a global RIP filter:

1. Display the **IP RIP Global Filter Table**.
2. Select an entry in the table.

3. Click . The entry is deleted.
4. Click . When the Status field displays “Finished!”, the fields are confirmed as modified.

To display IP Interface RIP Filter Table:

1. Display the **IP Interface RIP Filter Table**.
2. Select a filter in the table.
3. Click **Interface Filter**. The **IP Interface RIP Filter Table** opens:

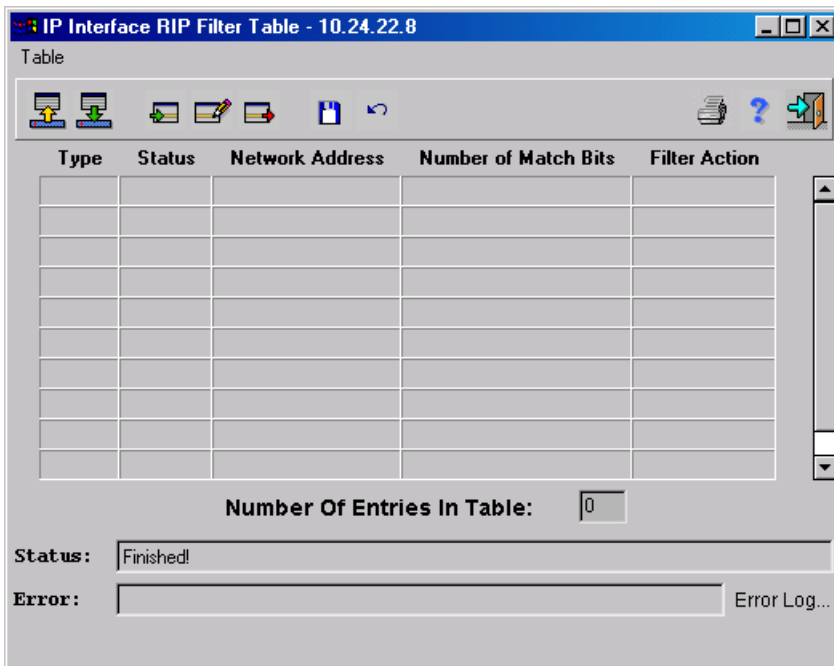

Figure 6- 103. IP Interface RIP Filter Table window

The **IP Interface RIP Filter Table** displays the following fields:

- ◆ **Type** – The filter is for input or output.
- ◆ **Status** – The filter is valid or not.
- ◆ **Network Address** – The IP address network
- ◆ **Number of Match Bits** – The number of bits to match the network IP address. A value less than 32 represents a wildcard.
- ◆ **Filter Action** – This parameter is used to fine-tune other filters. For example set a filter to block all RIP messages with net address 192.114 and set another filter entry to permit all RIP messages with the network 192.114.25. All RIP messages with the network 192.114 that do not end in 25 are blocked.
 - ◇ Permit – Whether the indicated packets should be forwarded.
 - ◇ Deny – Whether the indicated packets should be blocked.

To add a RIP interface filter:

1. Display the **IP Interface RIP Filter Table**.
2. Click . The **IP Interface RIP Filter Table Insert** window opens:

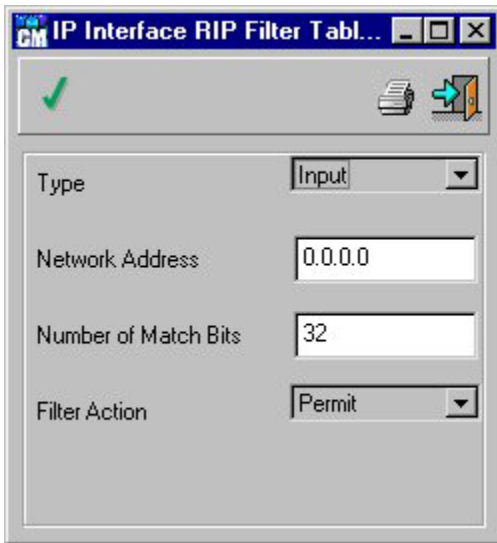









Figure 6- 104. IP Interface RIP Filter Table Insert window

3. Complete the fields.
4. Click .
5. Close the **IP Interface Filter RIP Table Insert** window. The **IP Interface RIP Filter Table** opens.
6. Click . When the Status field displays “Finished!”, the fields are confirmed as modified.

To edit a RIP interface filter:

1. Display the **IP Interface RIP Filter Table**.
2. Select an entry in the table.
3. Click . The **IP Interface Filter RIP Table Edit** window opens. The **RIP Global Filter Edit** is identical to the **IP Interface RIP Filter Table Insert** window.
4. Modify the required fields.
5. Click .
6. Close the **IP Interface Filter RIP Table Edit** window. The **IP Interface RIP Filter Table** opens.
7. Click . When the Status field displays “Finished!”, the fields are confirmed as modified.

To delete a RIP interface filter:

1. Display the **IP Interface RIP Filter Table**.
2. Select an entry in the table.
3. Click . The filter is deleted.
4. Click . When the Status field displays “Finished!”, the fields are confirmed as modified.

OSPF II

The **OSPF II** menu has the following menu options:

- ◆ Parameters
- ◆ Interface Parameters
- ◆ Area Table

- ◆ Link State Database
- ◆ External Link State Database
- ◆ Neighbors Table

Parameters

To display OSPF parameters:

- ◆ Select **Router > IP > OSPF II> Parameters**. The **OSPF Parameters** window opens:

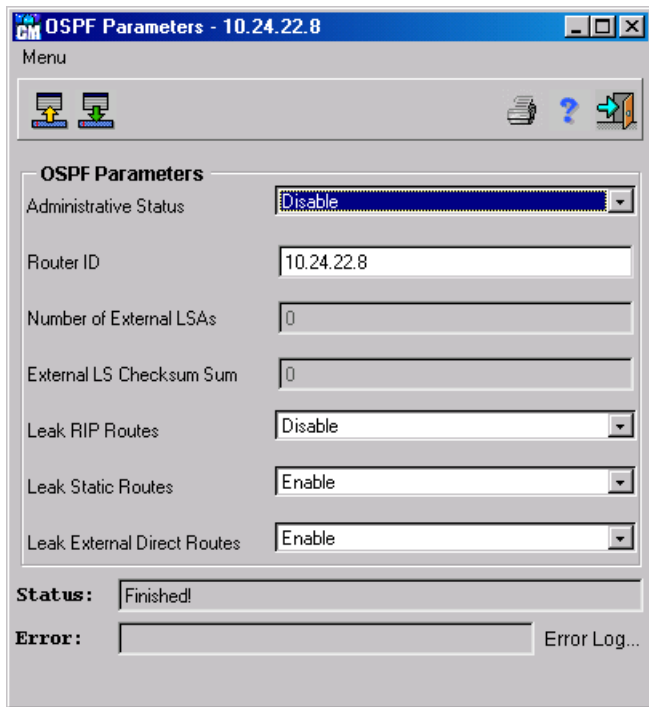



Figure 6- 105. OSPF Parameters window

The **OSPF Parameters** window displays the following fields:

- ◆ **Administrative Status** – The OSPF administrative status in the router. The field options are the following:
 - ◆ Enable – The OSPF process is active on at least one interface.
 - ◆ Disable – The process is not active on any interface.
- ◆ **Router ID** – The router ID number. To ensure uniqueness the router ID must be equal to one of the router IP addresses. By default, the router ID takes the IP Interface Address. Reset the device to allow changes in the router ID to take effect.
- ◆ **Number of External LSAs** – The number of external Link-State Advertisements in the link-state database.
- ◆ **External LS Checksum Sum** – The sum of LS checksums of external LS advertisements contained in the LS database. Use this sum to determine if there has been a change in a router LS database, and to compare the LS database of two routers.
- ◆ **Leak RIP Routes** – Controls the route redistribution from RIP into OSPF. When this parameter is enabled, all routes inserted into the IP routing table via SNMP are advertised into OSPF as external routes.
- ◆ **Leak Static Routes** – Controls route redistribution from static routes to RIP. When this parameter is enabled, all static routes learned via static are advertised into RIP.

◆ **Leak External Direct Routes** – Controls direct route redistribution that is external to OSPF into OSPF. If this parameter is enabled all external routes are advertised into OSPF as external routes.

To edit OSPF parameters:

1. Display the **OSPF Parameters** window.
2. Modify the required fields.
3. Click . When the Status field displays “Finished!”, the fields are confirmed as modified.

OSPF Interface Parameters

To display the OSPF Interface Table:

◆ Select **Router > IP > OSPF II > Interface Parameters**. The **OSPF Interface Table** opens:

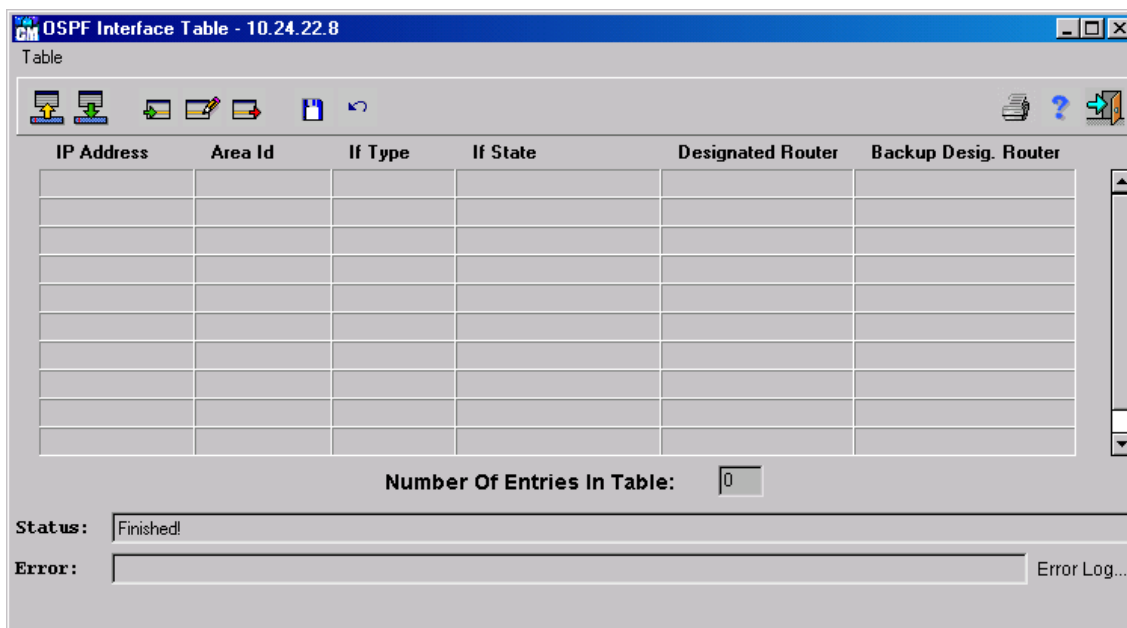



Figure 6- 106. OSPF Interface Table window

The **OSPF Interface Table** displays the following fields:

- ◆ **IP Address** – The OSPF interface IP address.
- ◆ **Area ID** – The area IP address.
- ◆ **If Type** – The interface type, such as Broadcast.
- ◆ **If State** – The OSPF interface states are the following:
 - ◇ Down – The OSPF interface is down.
 - ◇ Loopback – The OSPF interface is in a Loopback state.
 - ◇ Waiting – The OSPF interface is currently waiting.
 - ◇ Point to Point – The OSPF interface is in a point to point state.
 - ◇ Designated Router – The OSPF interface is the designated router.
 - ◇ Backup Designated Router – The OSPF interface is the backup designated router.
 - ◇ Other Designated Router – Other routers are the designated and backup routers.
- ◆ **Designated Router** – The designated router IP address.

- ◆ **Backup Desig. Router** – The backup designated router IP address.

To edit the OSPF Interface Table:

1. Display the **OSPF Interface Table**.
2. Select an entry in the table.
3. Click . The **OSPF Interface Table Edit** window opens:

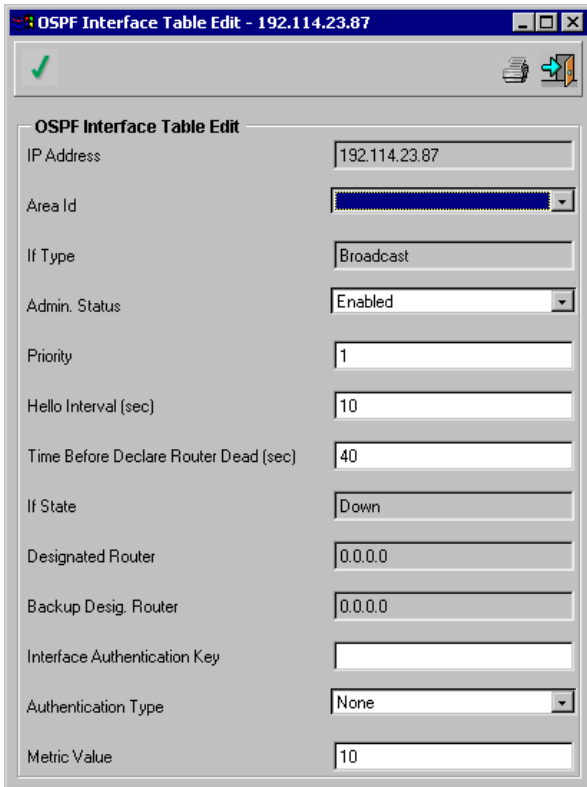



Figure 6- 107. OSPF Interface Table Edit window

The **OSPF Interface table Edit** displays the following additional parameters:

- ◆ **Admin Status** – The OSPF administrative status in the router. Enabled means that the OSPF process is active on at least one interface. Disabled means the process is not active on any interface.
- ◆ **Priority** – The priority of this interface. The value 0 means that this router is not eligible to become the designated router on the current network. If more than one router has the same priority, the router ID is used.
- ◆ **Hello Interval (sec)** – The amount of seconds between Hello packets. All routers attached to a common network must have the same Hello Interval.
- ◆ **Time Before Declare Router Dead (sec)** – The number of seconds a router Hello packet has not been detected, before the router neighbors declare the router to be down. The value must be a multiple of the Hello Interval value. All routers attached to a common network must have a value specified for this parameter.
- ◆ **Interface Authentication Key** – The interface authentication key.
- ◆ **Authentication Type** – The interface authentication type. For example, a password could be used for authentication.
- ◆ **Metric Value** – The metric for this type of service on the interface.

4. Edit the required fields. The IP Address field cannot be modified.

5. Click .
6. Close the **OSPF Interface Table Edit** window. The **OSPF Interface Table** opens.
7. Click . When the Status field displays “Finished!” the fields are confirmed as modified.

Area Table

Note: A device configured to support OSPF does not support virtual links.

A device supports up to 120 IP interfaces and up to 362 neighbors on one Area. OSPF supports leaks to RIP1 and RIP2.

To display the OSPF Area Table:

- ◆ Select **IP > OSPF II > Area Table**. The **OSPF Area Table** opens:

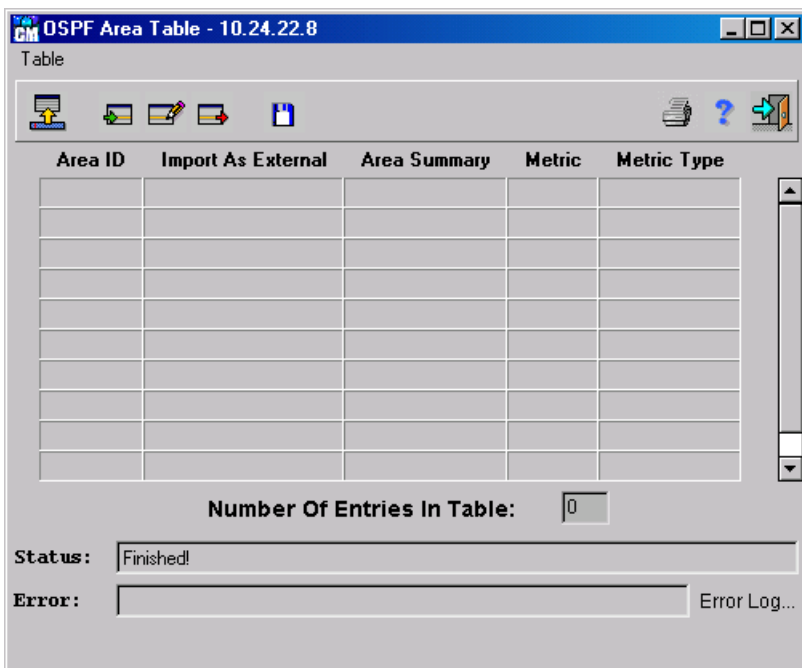

Figure 6- 108. OSPF Area Table window

The **OSPF Area Table** displays the following parameters:

- ◆ **Area ID** – The area IP address.
- ◆ **Import as External** – The area support for importing as external link state advertisement.
- ◆ **Area Summary** – Controls the import of summary LSAs into stub areas. This variable has no effect on other areas.
 - ◇ No Area Summary – The router neither originates nor distributes summary LSAs into the stub area. It relies on its default route.
 - ◇ Send Area Summary – The router both summarizes and distributes summary LSAs.
- ◆ **Metric** – The metric for this type of service on the interface.
- ◆ **Metric Type** – The metric protocol type.

To add an OSPF area:

1. Display the **OSPF Area Table**.
2. Click . The **OSPF Area Table Insert** window opens:

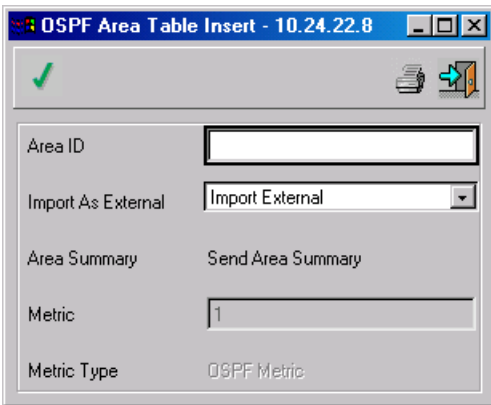









Figure 6- 109. OSPF Area Table Insert window

1. Complete the fields.
2. Click .
3. Close the **OSPF Area Table Insert** window. The **OSPF Area Table** opens.
4. Click . When the Status field displays “Finished!”, the fields are confirmed as modified.

To edit an OSPF Area Table entry:

1. Display the **OSPF Area Table**.
2. Select an in the table.
3. Click . The **OSPF Area Table Edit** window opens. The **OSPF Area Table Edit** is identical to the **OSPF Area Table Insert** window.
4. Edit the required fields. The Area ID field cannot be edited.
5. Click .
6. Close the **OSPF Area Table Edit** window. The **OSPF Area Table** opens.
7. Click . When the Status field displays “Finished!”, the fields are confirmed as modified.

To delete an OSPF Table entry:

1. Display the **OSPF Area Table Edit** window.
2. Select an entry in the table.
3. Click . The area is deleted.
4. Click . When the Status field displays “Finished!”, the fields are confirmed as modified.

Link State Database

This is a read-only command. The database cannot be modified.

To display the Link State Database:

- ◆ Select **Router > IP > OSPF II > Link State Database**. The **Link State Database** window opens:

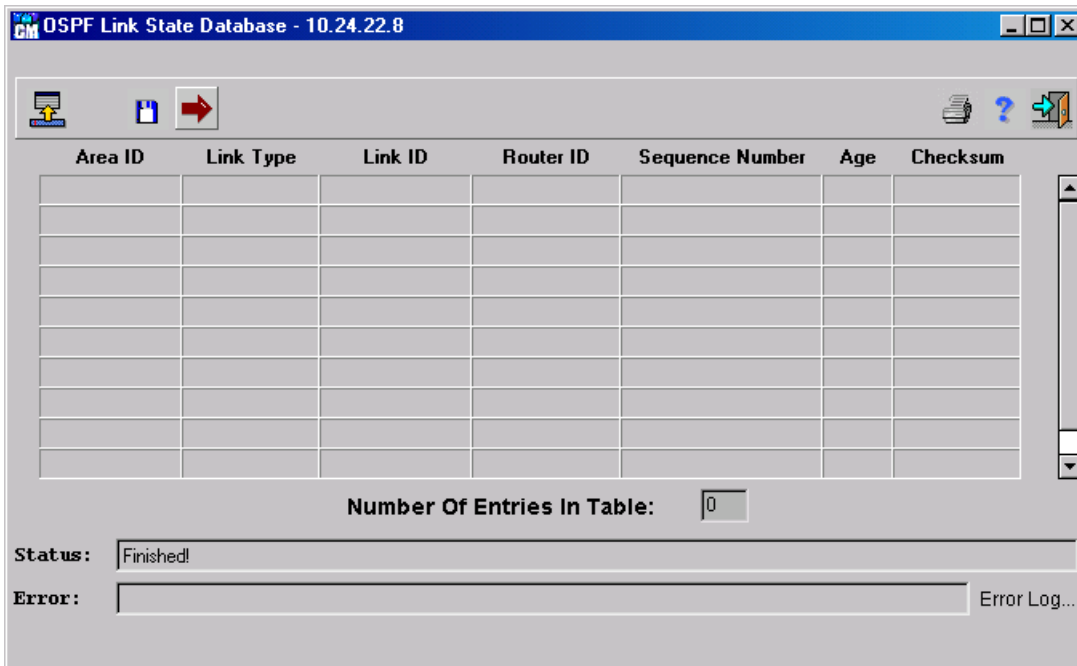

Figure 6- 110. OSPF Link State Database window

The **Link State Database** window displays the following parameters:

- ◆ **Area ID** – The link IP address.
- ◆ **Link Type** – Each link state advertisement has a specific format. The link is a Router Link, Network Link, External Link, Summary Link or Stub Link.
- ◆ **Link ID** – Identifies the routing domain piece described by the advertisement. It is either a router ID or an IP address.
- ◆ **Router ID** – Identifies the originating router in the autonomous system.
- ◆ **Sequence Number** – The number for the link. This parameter is used to detect old and duplicate links state advertisements. The larger the sequence number the more recent the advertisement.
- ◆ **Age** – The link age state advertisement in seconds.
- ◆ **Checksum** – This parameter is a checksum of the advertisement complete contents, excluding the Age value.

External Link State Database

To display the OSPF External Link State Database Table:

- ◆ Select **Router > IP > OSPF II > External Link State Database**. The **OSPF External Link State Database Table** opens:

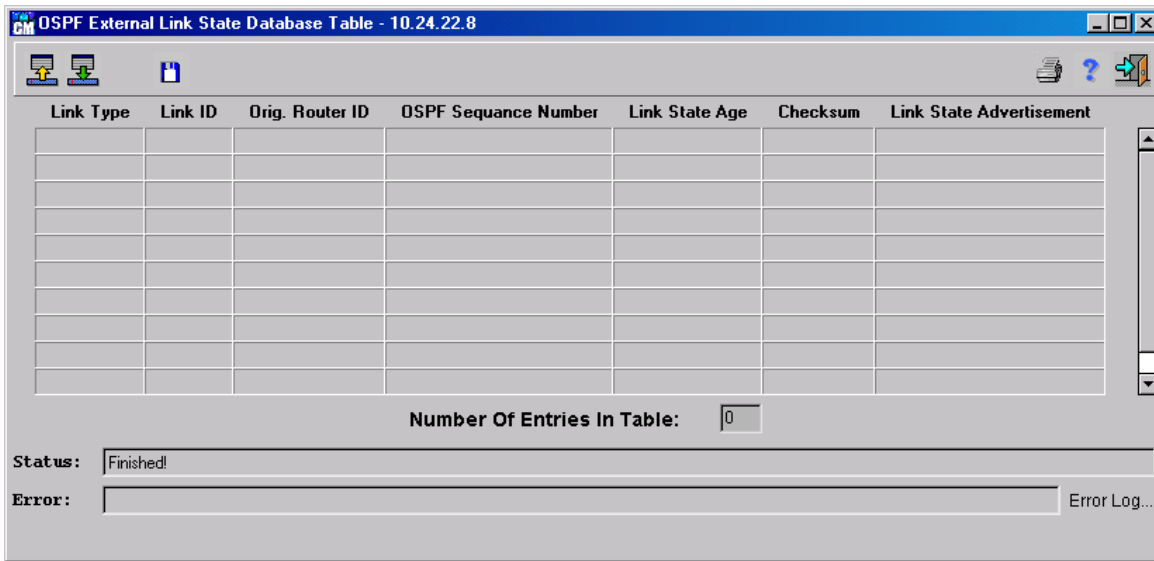

Figure 6- 111. OSPF External Link State Database Table window

The **OSPF External Link State Database Table** displays the following parameters:

- ◆ **Link Type** – Each link state advertisement has a specific format. The link is a Router Link, Network Link, External Link, Summary Link or Stub Link.
- ◆ **Link ID** – Identifies the routing domain piece described by the advertisement. It is either a router ID or an IP address.
- ◆ **Orig. Router ID** – Identifies the originating router in the autonomous system.
- ◆ **OSPF Sequence Number** – The number for the link. This parameter is used to detect old and duplicate links state advertisements. The larger the sequence number the more recent the advertisement.
- ◆ **Link State Age** – The link state advertisement age, in seconds.
- ◆ **Checksum** – The complete advertisement contents checksum, excluding the Age.
- ◆ **Link State Advertisement** – The link state advertisement, containing the header and contents.

Neighbors Table

To display the OSPF Neighbors Table:

- ◆ Select **Router > IP > OSPF II > Neighbors Table**. The **OSPF Neighbors Table** opens:

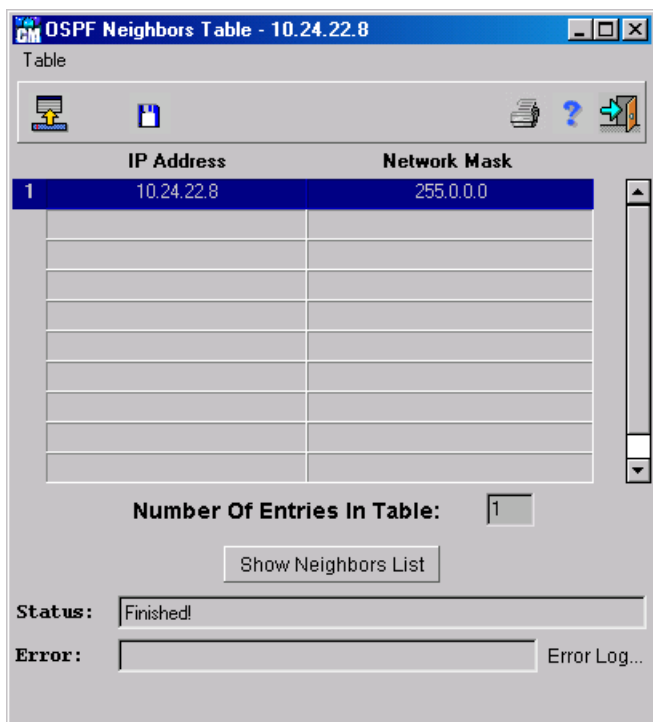

Figure 6- 112. OSPF Neighbors Table window

The **OSPF Neighbors Table** displays the following parameters:

- ◆ **IP Address** – The neighbor interface IP address.
- ◆ **Network Mask** – The neighbor network address interface.

To display a selected OSPF neighbor list:

1. Display the **OSPF Neighbors Table**.
2. Select a row in the **OSPF Neighbors Table** and click the **Show Neighbor List** button. The read-only **OSPF Neighbors Table Interface** window opens:

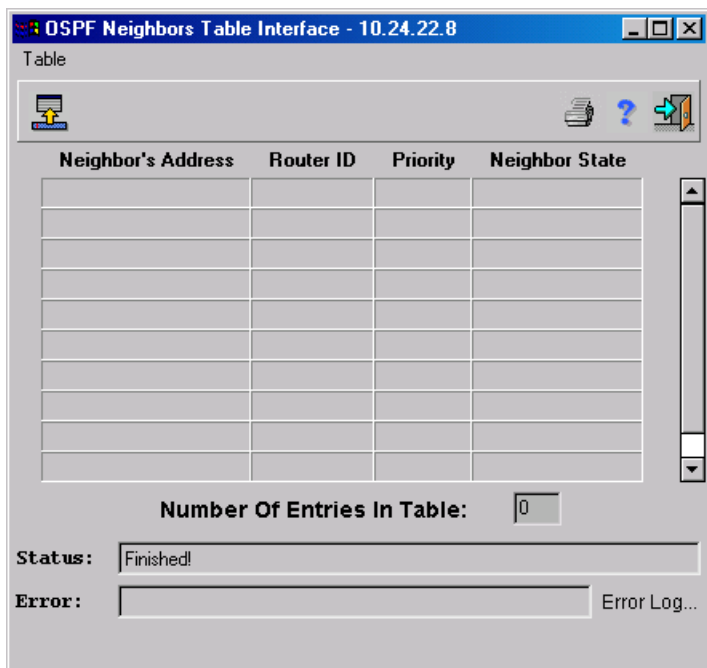

Figure 6- 113. OSPF Neighbors Table Interface window

The **OSPF Neighbors Table Interface** displays the following parameters:

- ◆ **Neighbor's Address** – The neighbor IP address.
- ◆ **Router ID** – A unique neighboring router identifier in the autonomous system.
- ◆ **Priority** – The priority of this neighbor. A priority of 0 means that this neighbor is not eligible to become the designated router on this network.
- ◆ **Neighbor State** – The relationship with neighbor state. The possible values are:
 - ◇ Down
 - ◇ Attempt
 - ◇ Ini
 - ◇ Two Way
 - ◇ Exchange Start
 - ◇ Exchange
 - ◇ Loading
 - ◇ Full.

Routing Table

To display the IP Routing Table:

- ◆ Select **Router > IP > Routing Table**. The **IP Routing Table** opens:

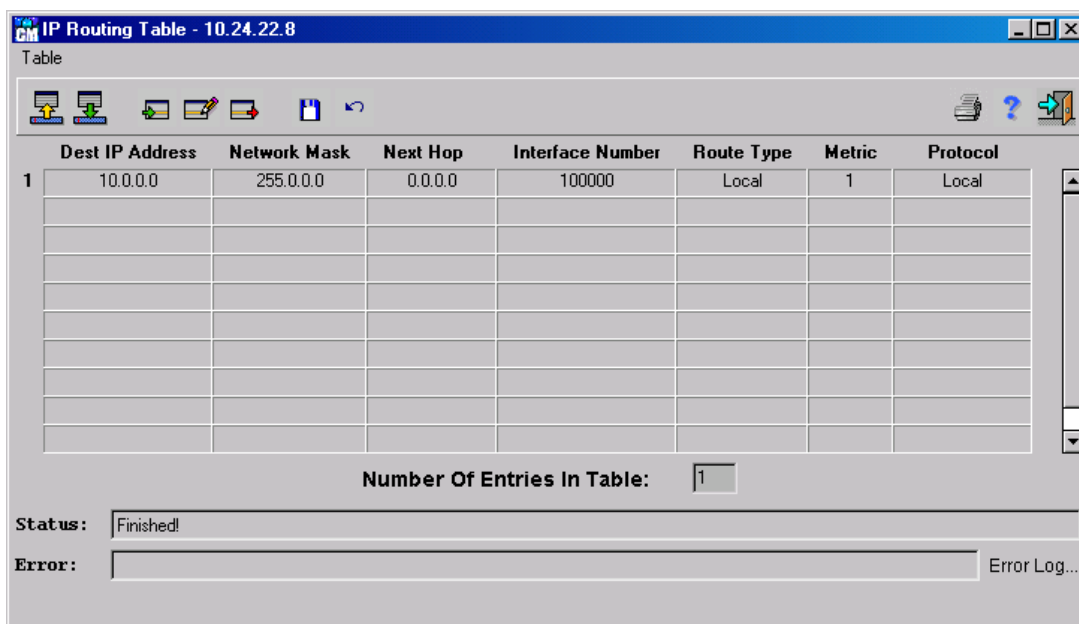

Figure 6- 114. IP Routing Table window

The **IP Routing Table** displays the following parameters:

- ◆ **Dest IP Address** – The destination IP address of this router.
- ◆ **Network Mask** – The destination network mask of this route.
- ◆ **Next Hop** – Address of the next system in this route, central to the interface.
- ◆ **Interface Number** – The central interface Index through which the next hop of this route is reached.

- ◆ **Route Type** – How remote routing is handled.
- ◆ **Metric** – Number of hops to the destination network.
- ◆ **Protocol** – Through which protocol the route is known.

To add an IP Routing entry:

1. Display the **IP Routing Table**.
2. Click . The **IP Routing Table Insert** window opens:

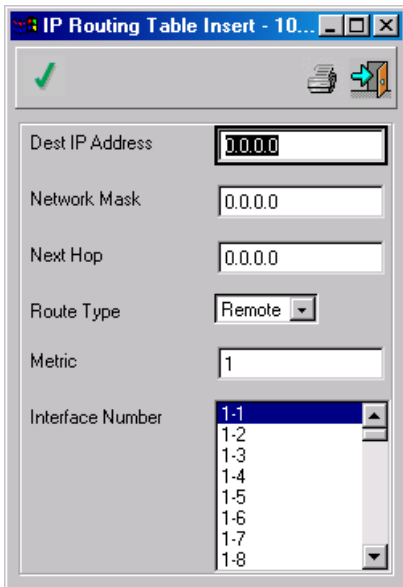





Figure 6- 115. IP Routing Table Insert window

3. Complete the fields.
4. Click .
5. Close the **IP Routing Table Insert** window. The **IP Routing Table** opens.
6. Click . When the Status field displays “Finished!”, the fields are confirmed as modified.

To edit an IP Routing entry:

1. Display the **IP Routing Table**.
2. Select an entry in the table.
3. Click . The **IP Routing Table Edit** window opens:

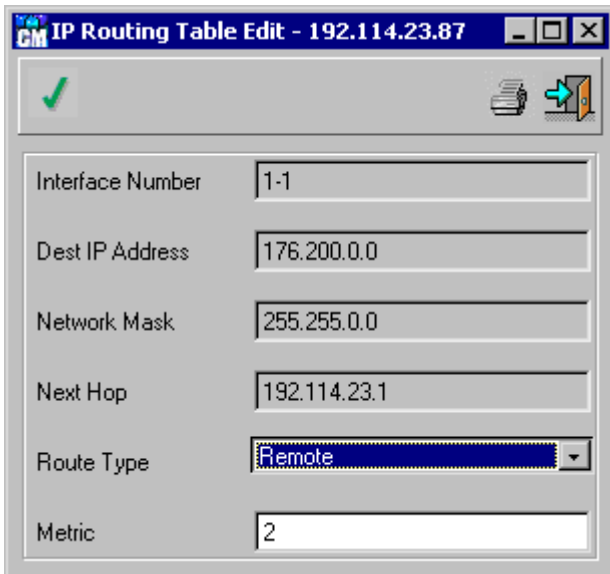



Figure 6- 116. IP Routing Table Edit window

4. Edit the required fields.

Note: The *Edit* command is available for remote routers only.

5. Click .
6. Close the **IP Routing Table Edit** window. The **IP Routing Table** opens.
7. Click . When the Status field displays “Finished!”, the fields are confirmed as modified.

To delete an IP Routing entry:

1. Display the **IP Routing Table**.
2. Select an entry in the table.
3. Click . The entry is deleted.
4. Click . When the Status field displays “Finished!”, the fields are confirmed as modified.

ARP Table

To display the Global ARP Table:

- ◆ Select **Router > IP > ARP table**. The **Global ARP Table** opens:

	Interface	IP Address	MAC Address	Class
1	100000	10.1.1.12	00:80:C8:42:65:CF	Dynamic
2	100000	10.1.1.50	00:D0:59:0F:02:50	Dynamic
3	100000	10.1.1.254	00:01:30:FA:5F:00	Dynamic
4	100000	10.5.55.3	00:40:05:2E:B2:98	Dynamic
5	100000	10.10.27.59	00:80:C8:5A:8F:F8	Dynamic
6	100000	10.16.60.10	00:80:C8:5A:F1:F4	Dynamic
7	100000	10.17.24.0	00:80:C8:64:74:7F	Dynamic
8	100000	10.17.42.222	00:80:C8:93:B4:7B	Dynamic
9	100000	10.20.39.211	00:A0:B0:16:B0:11	Dynamic
10	100000	10.22.34.106	00:40:05:51:DE:04	Dynamic

Number Of Entries In Table: 23

Read From: 100000

Status: Finished

Error: Error Log...

Figure 6- 117. Global ARP Table window

The **Global ARP Table** displays the following parameters:

- ◆ **Interface** – The interface number on which the station resides.
- ◆ **IP Address** – The station IP address.
- ◆ **MAC Address** – The station MAC address.
- ◆ **Class** – Entry type:
 - ◇ Dynamic – The entry is learned from the ARP protocol. If the entry is not active for a predetermined time, the node is deleted from the table.
 - ◇ Static – The entry is configured by the network management station and is permanent.

To add a Global ARP Table entry:

1. Display the **Global ARP Table**.
2. Click . The **Global ARP Table Insert** window opens:

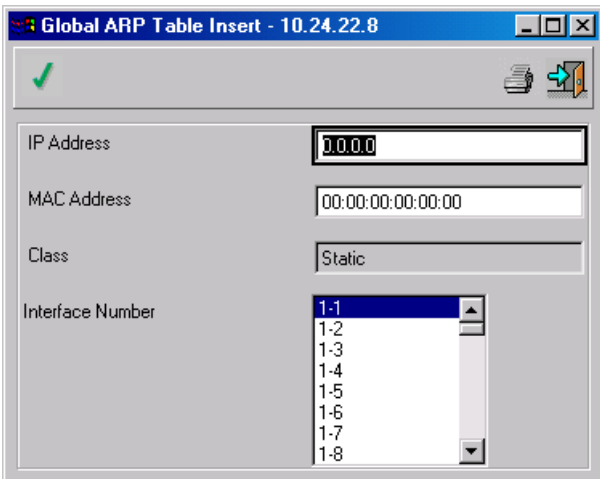





Figure 6- 118. Global ARP Table Insert window

3. Complete the fields.
4. Click .
5. Close the **Global ARP Table Insert** window. The **Global ARP Table** opens.
6. Click . When the Status field displays “Finished!”, the fields are confirmed as modified.

To edit a Global ARP Table entry:

1. Display the **Global ARP Table**.
2. Select an entry in the table.
3. Click . The **Global ARP Table Edit** window opens:

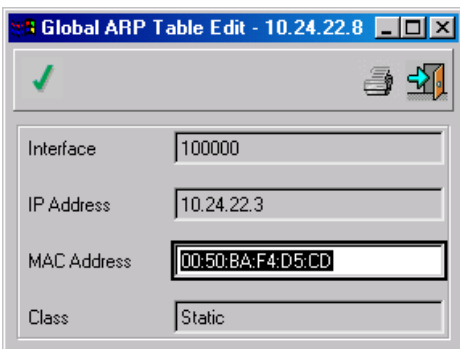



Figure 6- 119. Global ARP Table Edit window

4. Edit the required fields.
5. Click .
6. Close the **Global ARP Table Edit** window. The **Global ARP Table** opens.
7. Click . When the Status field displays “Finished!”, the fields are confirmed as modified.

To delete a Global ARP Table entry:

1. Display the **Global ARP Table**.
2. Select an entry in the table.

3. Click . The entry is deleted.
4. Click . When the Status field displays “Finished!”, the fields are confirmed as modified.

IP Redundancy

To display the IP Redundancy Table:

- ◆ Select **Router > IP > IP Redundancy**. The **IP Redundancy Table** opens:

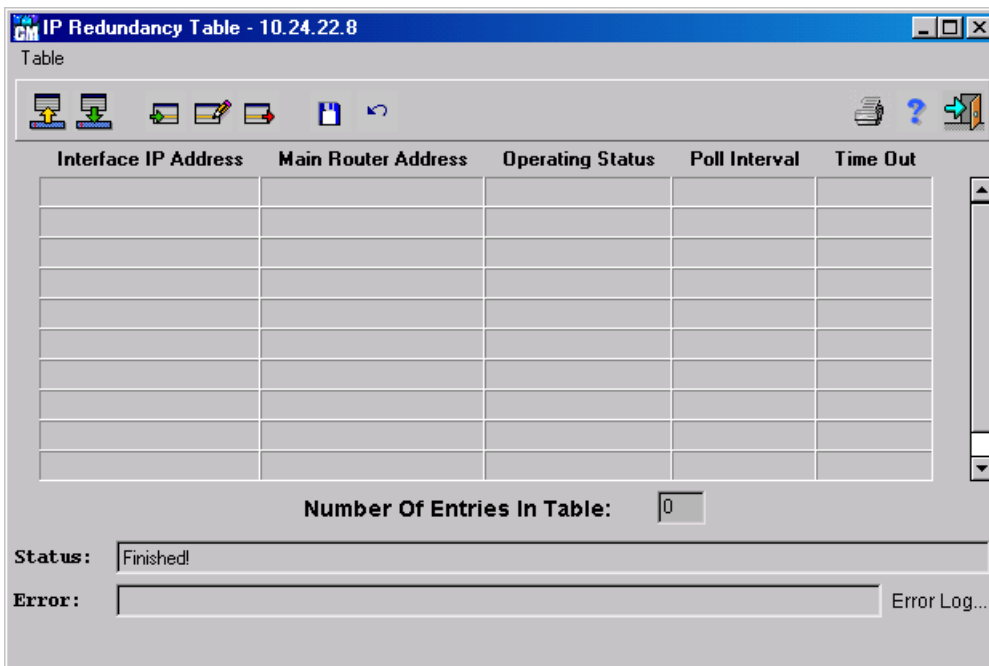

Figure 6- 120. IP Redundancy Table window

The **IP Redundancy Table** displays the following parameters:

- ◆ **Interface IP Address** – The IP address on which the redundancy feature is running.
- ◆ **Main Router Address** – The router IP address that the device is backing up.
- ◆ **Operating Status** – The entry status:
 - ◇ Active – The backup router is active on this interface.
 - ◇ Inactive – The backup router is not active on this interface.
- ◆ **Poll Interval** – This router-polling interval, in seconds. If the interval is 0 then the router is not polled.
- ◆ **Time Out** – The interval in seconds during which the router must signal. If the router does not signal within this interval it is considered non-operational. If Time Out is equal to 0, the device ignores the row.

To add an IP Redundancy Table entry:

1. Display the **IP Redundancy Table**.
2. Click . The **IP Redundancy Table Insert** window opens:

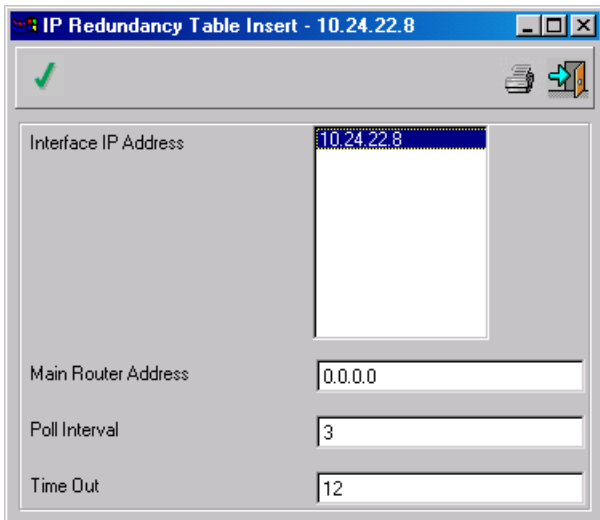









Figure 6- 121. IP Redundancy Table Insert window

3. Complete the fields.
4. Click .
5. Close the **IP Redundancy Table Insert** window. The **IP Redundancy Table** opens.
6. Click . When the Status field displays “Finished!”, the fields are confirmed as modified.

To edit an IP Redundancy Table entry:

1. Display the **IP Redundancy Table**.
2. Select an entry in the table.
3. Click , and edit the fields.
4. Click .
5. Close the **IP Redundancy Table Edit** window. The **IP Redundancy Table** opens.
6. Click . When the Status field displays “Finished!”, the fields are confirmed as modified.

To delete an IP Redundancy Table entry:

1. Display the **IP Redundancy Table**.
2. Select an entry in the table.
3. Click . The entry is deleted.
4. Click . When the Status field displays “Finished!”, the fields are confirmed as modified.

DHCP

The central DHCP server acts as a relay for DHCP and BootP requests originating from remote IP subnets.

DHCP Relays Table

To display the DHCP Relays Table:

- ◆ Select **Router > IP > DHCP > DHCP Relays Table**. The **DHCP Relays Table** window opens:

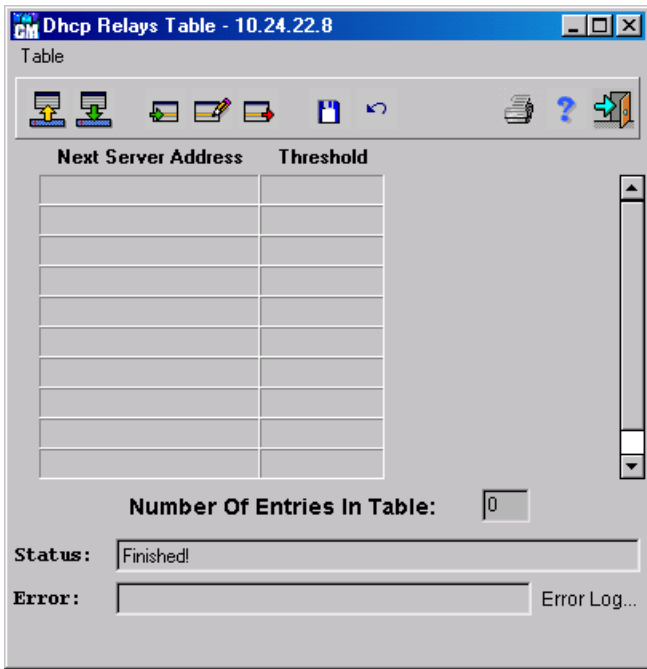



Figure 6- 122. DHCP Relays Table window

The **DHCP Relays Table** window displays the following parameters:

- ◆ **Next Server Address** – The DHCP server IP address. The device acts as a DHCP relay if this parameter is not equal to 0.0.0.0.
- ◆ **Threshold** – DHCP requests are relayed only if their SEC field is greater or equal to the threshold value, in order to allow local DHCP servers to answer first.

To add a DHCP Relays Table entry:

1. Display the **DHCP Relays Table** window.
2. Click . The **rsDHCP Multiple Relays Entry - Insert** window opens:

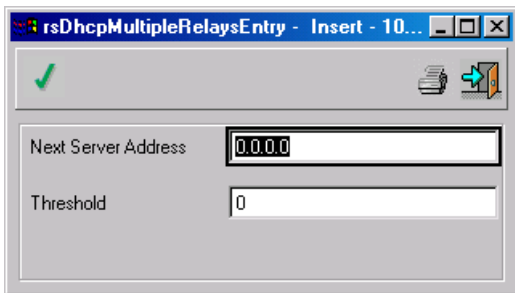



Figure 6- 123. rsDHCP Multiple Relays Entry – Insert window

3. Complete the fields.
4. Click .
5. Close the **rsDHCP Multiple Relays Entry - Insert** window. The **DHCP Relays Table** opens.
6. When the Status field displays “Finished!”, the fields are confirmed as modified.

To edit a DHCP Relays Table entry:

1. Display the **DHCP Relays Table** window.

2. Select an entry in the table.
3. Click . The **rsDHCP Multiple Relays Entry - Edit** window opens:

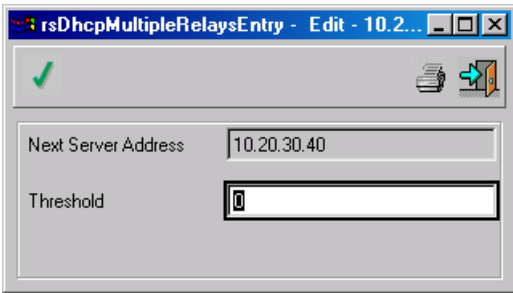



Figure 6- 124. rsDHCP Multiple Relays Entry - Edit window

4. Edit the required fields.
5. Click .
6. Close the **rsDHCP Multiple Relays Entry - Edit** window. The **DHCP Relays Table** opens.
7. When the Status field displays “Finished!”, the fields are confirmed as modified.

To delete a DHCP Relay Table entry:

1. Display the **DHCP Relays Table**.
2. Select an entry in the table.
3. Click . The entry is deleted.

UDP Relay

A device supports UDP Relay to allow UDP packets to reach other networks. This feature enables browsing from NT workstations to NT-servers on different networks.

To display the UDP Relay Table:

- ◆ Select **Router > IP > UDP Relay**. The **UDP Relay Table** opens:

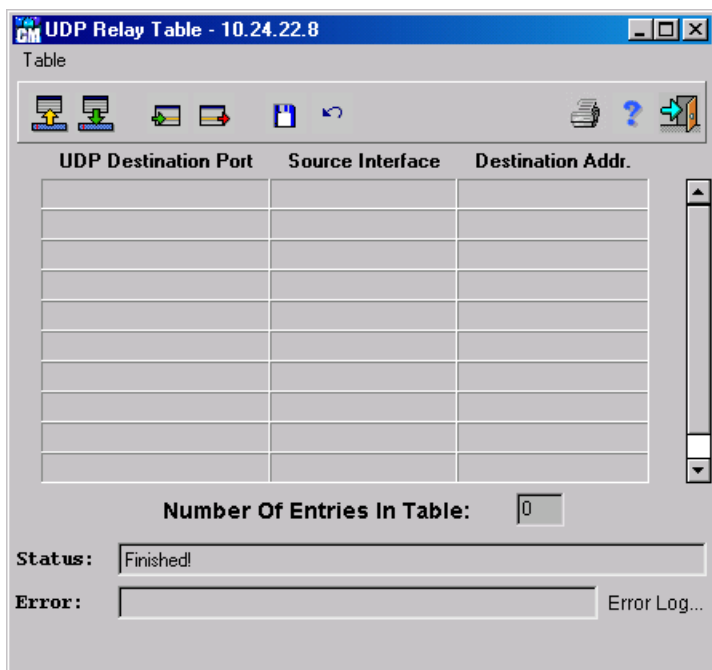

Figure 6- 125. UDP Relay Table window

The **UDP Relay Table** displays the following parameters:

- ◆ **UDP Destination Port** – The destination UDP port ID number of UDP packets to be relayed. The following table lists UDP Port allocations.

Note: *UDP Ports 137 and 138 are the most commonly used.*

UDP Ports

UDP Port #	Acronym	Application
7	ECHO	Echo
11	USERS	Active Users
13	DAYTIME	Daytime
15	NETSTAT	Netstat
17	QUOTE	Quote Of The Day
19	CHARGEN	Character Generator
37	TIME	Time
42	NAMESERVER	Host Name Server
43	NICNAME	Who Is
53	DOMAIN	Domain Name Server
67	BOOTPS	Bootstrap Protocol Server
68	BOOTPC	Bootstrap Protocol Client
69	TFTP	Trivial File Transfer
111	SUNRPC	Sun Microsystems Rpc
123	NTP	Network time
137	NetBiosNameService	NT Server to Station Connections
138	NetBiosDatagramService	NT Server to Station Connections

UDP Port #	Acronym	Application
139	NetBios SessionService	NT Server to Station Connections
161	SNMP	Simple Network Management
162	SNMP	Simple Network Management Traps
513		Unix Rwho Daemon
514	Syslog	System Log
525	Timed	Time Daemon

Table 6-6. UDP Ports

◆ **Source Interface** – The input IP interface that relays UDP packets. If this field is 255.255.255.255, UDP packets from all interfaces are relayed. The following address ranges are invalid:

- ◇ 0.0.0.0 to 0.255.255.255
- ◇ 127.0.0.0 to 127.255.255.255

◆ **Destination Addr.** – The IP interface that receives UDP frame relays. If this field is 0.0.0.0, UDP packets are discarded. If this field is 255.255.255.255, UDP packets are flooded to all IP interfaces.

An example of UDP Relay table use: To relay all UDP packets to interface 7.7.7.7 arriving at UDP port 138, while discarding those packets which come from the Source IP Addresses 1.1.1.1 and 2.2.2.2, type in these table entries:

Port	Source	Destination
138	1.1.1.1	0.0.0.0
138	2.2.2.2	0.0.0.0
138	255.255.255.255	7.7.7.7

To add a UDP Relay Table entry:

1. Display the **UDP Relay Table**.
2. Click . The **UDP Relay Table Insert** window opens:

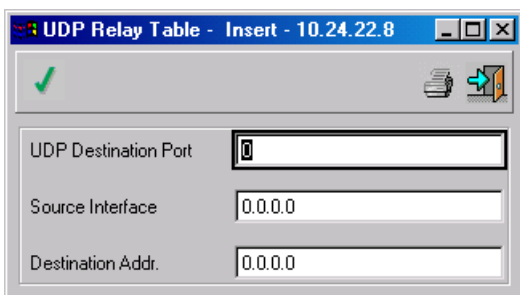





Figure 6- 126. UDP Relay Table - Insert window

3. Complete the fields.
4. Click .
5. Close the **UDP Relay Table Insert** window. The **UDP Relay Table** opens.
6. Click . When the Status field displays “Finished!”, the fields are confirmed as modified.

To delete a UDP Relay Table entry:

1. Display the **UDP Relay Table**.
2. Select an entry in the table.
3. Click . The entry is deleted.
4. Click . When the Status field displays “Finished!”, the fields are confirmed as modified.

TCP General Parameters

The **TCP General Parameters** window displays information about how TCP is implemented on the device.

To display the TCP General Parameters:

- ◆ Select **Router > IP > TCP General Parameters**. The **TCP Parameters** window opens:

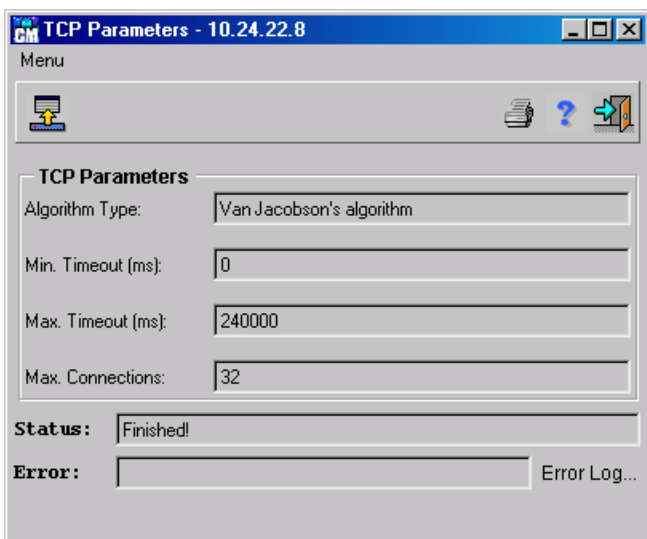

Figure 6- 127. TCP Parameters window

The **TCP Parameters** window displays the following parameters:

- ◆ **Algorithm Type** – The Algorithm used to determine the timeout value used for re-transmitting unacknowledged octets.
- ◆ **Min. Timeout (ms)** – The minimum value permitted by a TCP implementation for the re-transmission timeout, measured in milliseconds.
- ◆ **Max. Timeout (ms)** – The maximum value permitted by a TCP implementation for the re-transmission timeout, measured in milliseconds.
- ◆ **Max. Connections** – The limit on the total number of TCP connections the entity can support. In entities where the maximum number of connections is dynamic, this object contains the value -1.

TCP Connections Table

To display the TCP Connections Table:

- ◆ Select **Router > IP > TCP Connection Table**. The **TCP Connections Table** opens:

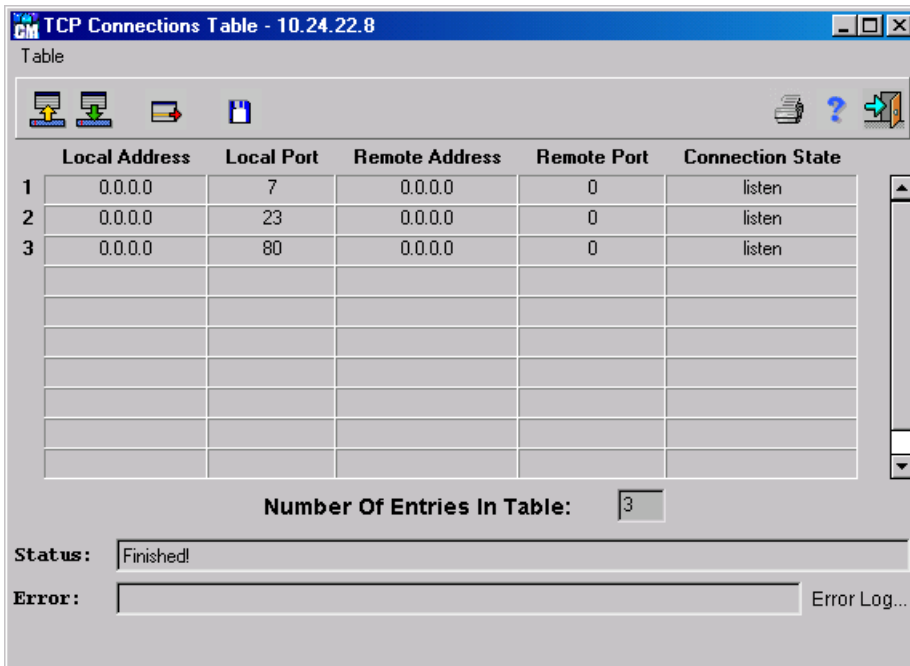



Figure 6- 128. TCP Connections Table window

The **TCP Connections Table** window displays the following parameters:

- ◆ **Local Address** – Indicates the local IP address for this TCP connection. IF the connection in the *Listen* state, the value 0.0.0.0 is used. The device accepts connections for any IP interface associated with the node.
- ◆ **Local Port** – Indicates the local port number for this TCP connection.
- ◆ **Remote Address** – Indicates the remote IP address for this TCP connection.
- ◆ **Remote Port** – The remote port number for this TCP connection.
- ◆ **Connection State** – Indicates the status of this TCP connection. The only value set by a management station is *DeleteTCB* (TCP Control Block). This is done by deleting the specific entry using the management system.

To delete a TCP Connection Table entry:

1. Display the **TCP Parameters** window.
2. Select an entry in the table.
3. Click . The entry is deleted.
4. Click . When the Status field displays “Finished!”, the fields are confirmed as modified.

IPM

Multicast routing occurs when IP routers determine how to forward multicast IP packets, either from a specific multicast group to a source or from a nonspecific source to a multicast group.

The **IPM** menu option has the following menu options:

- ◆ Operating Parameters
- ◆ IGMP
- ◆ Filter
- ◆ PIM

- ◆ IPM Routing

IPM Operating Parameters

The **IPM Operating Parameters** window enables IPM Routing on a device.

To display the IPM Operating Parameters window:

- ◆ Select **Router > IPM > Operating Parameters**. The **IPM Operating parameters** window opens:

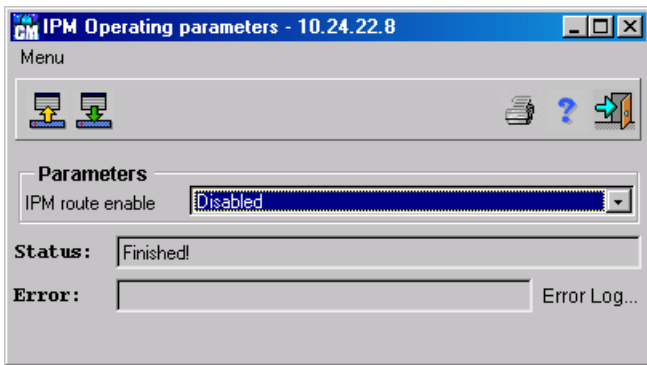

Figure 6- 129. IPM Operating parameters window

The **IPM Operating parameters** window displays the following field:

- ◆ **IPM routing enable** – Enables IPM routing on a device. *Disabled* is the default.

To enable IPM routing on a device:

1. Display the **IPM Operating Parameters** window.
2. Set the IPM Routing status to *Enabled*.
3. Click to update the device. When the Status field displays “Finished!”, IPM Routing is enabled on the device.

IGMP

The Internet Group Management Protocol (IGMP) establishes host memberships within a multicast group. IGMP allows devices to notify routers that they can receive multicast packets addressed to specific multicast groups.

Note: *Ports belonging to a VLAN without IGMP membership are not forwarded multicast traffic.*

The **IGMP** menu has the following menu options:

- ◆ Parameters
- ◆ Interface Table
- ◆ Cache Table

IGMP Operating Parameters

The **IGMP Operating Parameters** window displays information regarding IGMP MIB software version.

To display the IGMP Operating Parameters window:

- ◆ Select **Router > IPM > IGMP > Parameters**. The **IGMP Parameters** window opens:

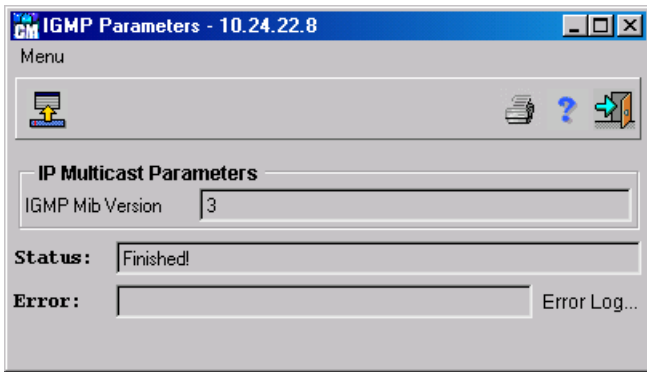

Figure 6- 130. IGMP Parameters window

The **IGMP Parameters** window displays the following field:

- ◆ **IGMP Mib Version** – Indicates the MIB software version.

IGMP Interface Table

The **IGMP Interface Table** contains IGMP information for which IGMP is currently enabled.

To display the IGMP Interface Table:

- ◆ Select **Router > IPM > IGMP > Interface Table**. The **IGMP Interface Table** opens:

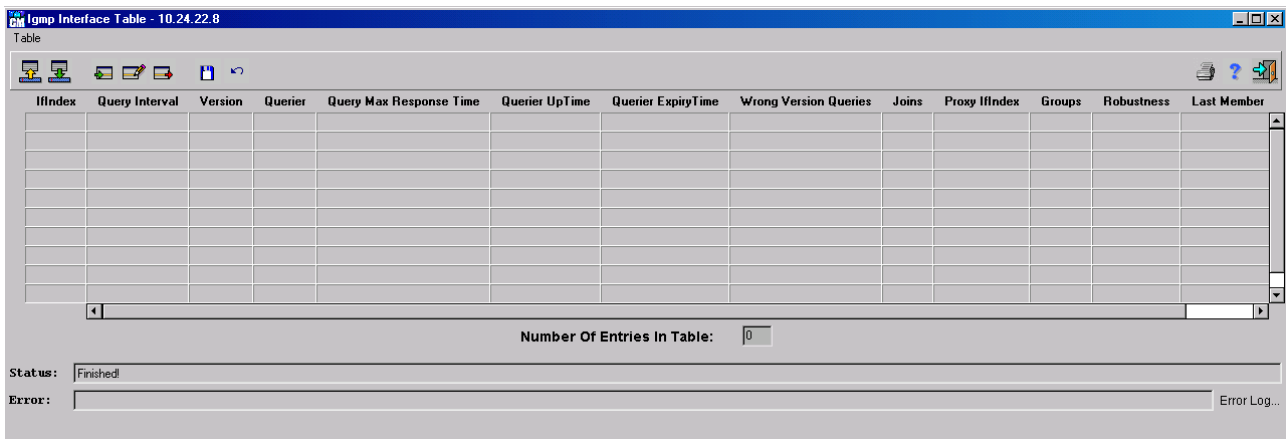

Figure 6- 131. IGMP Interface Table window

The **IGMP Interface Table** displays the following fields:

- ◆ **IfIndex** – Identifies the port number for which IGMP is enabled.
- ◆ **Query Interval** – Indicates the amount of time in seconds that querier messages are transmitted. Network managers can adjust the amount of IGMP messages sent on sub-networks by adjusting the value of the Query Interval. The larger value, the less often IGMP messages are sent. The default value is 125 seconds.
- ◆ **Version** – Indicates the current software version of IGMP. The default software version is 2.

Note: All routers on a LAN must be configured to the same IGMP software version.

- ◆ **Querier** – Indicates the IGMP Querier on the IP subnet. The multicast router with the lowest IP address is the multicast querier.
- ◆ **Query Max Response Time** – Indicates the maximum response time for advertising IGMP queries. Query Max Response time adjusts the amount of traffic on a per sub-network basis. Varying the response time effects the burstiness of network traffic. The higher the value the longer period of time passes between host responses. The default value is 10 seconds.

Note: The Query Max Response Time must be less than the Query Interval.

- ◆ **Querier UpTime** – Indicates the amount of time in ticks since the querier was last changed.
- ◆ **Querier Expiry Time** – Indicates the amount of time in ticks before the Querier Present timer expires. If the local system is the Querier the value is 0.
- ◆ **Wrong Version Queries** – Indicates the amount of queries received with the IGMP software version that do not match the IGMP interface's software version. If queries are received with a different software version the Wrong Software version Queries indicates a configuration error.
- ◆ **Joins** – Indicates the number of times a group membership has been added to the **IGMP Cache Table**.
- ◆ **Proxy ifIndex** – Indicates that IGMP is performed by proxy. IGMP Host Membership reports are sent to the device. A value of 0 indicates that IGMP proxying is not being performed. The default is 0.
- ◆ **Groups** – The current number of entries for this port in the **IGMP Cache Table**.
- ◆ **Robustness** – Tunes packet loss on a subnet. The robustness is increased to avoid packet loss on a subnet. Possible values are 1-255. The default value is 0.
- ◆ **Last Member Query Interval** – Modifies the leave latency of the network. A reduced value reduces the amount of time needed to detect the loss of the last group member. The possible values are 0-255. The default value is 10.

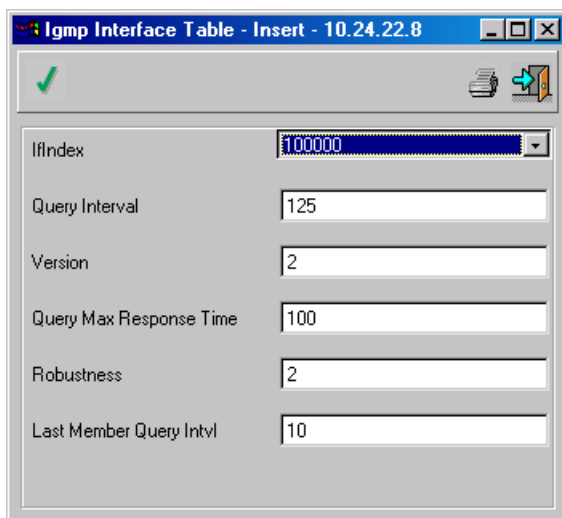

To add an IGMP Interface entry:

1. Display the **IGMP Interface Table**.
2. Click . The **IGMP Interface Table - Insert** window opens:



Field	Value
IfIndex	1000000
Query Interval	125
Version	2
Query Max Response Time	100
Robustness	2
Last Member Query Intvl	10

Figure 6- 132. IGMP Interface Table - Insert window

3. Complete the fields. The fields are the same as the **IGMP Interface Table** as described above.
4. Click . The **IGMP Interface Table - Insert** window closes.
5. Click  to update the device. When the Status field displays “Finished!” the IGMP information is saved to the device.

Note: An IGMP Interface entry can be added for an IP Address only.

To edit an IGMP Interface entry:

1. Display the **IGMP Interface Table**.
2. Select an entry in the **IGMP Interface Table** and click . The **IGMP Interface Table - Edit** window opens.

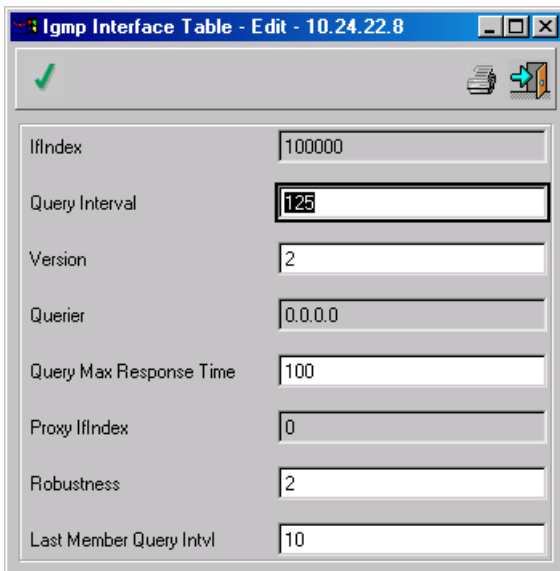

or

Double-click a row in the **IGMP Interface Table**. The **IGMP Interface Table-Edit** window opens:





IfIndex	100000
Query Interval	125
Version	2
Querier	0.0.0.0
Query Max Response Time	100
Proxy IfIndex	0
Robustness	2
Last Member Query Intvl	10

Figure 6- 133. IGMP Interface Table - Edit window

3. Edit the fields. The fields are the same as the **IGMP Interface Table** as described above.
4. Click . The **IGMP Interface Table - Edit** window closes.
5. Click . When the Status field displays “Finished!”, the IGMP information is saved to the device.

To delete an entry in the IGMP Interface Table:

1. Display the **IGMP Interface Table**.
2. Select an entry in the table.
3. Click . The entry is deleted from the **IGMP Interface Table**.
4. Click  to update the device. When the Status field displays “Finished!”, the entry is deleted from the device.

IGMP Cache Table

The **IGMP Cache Table** contains information regarding each IP Multicast group whose members are part of an interface on a physical port.

To display the Cache Table:

- ◆ Select **Router > IPM > IGMP > Cache Table**. The **IGMP Cache Table** opens:

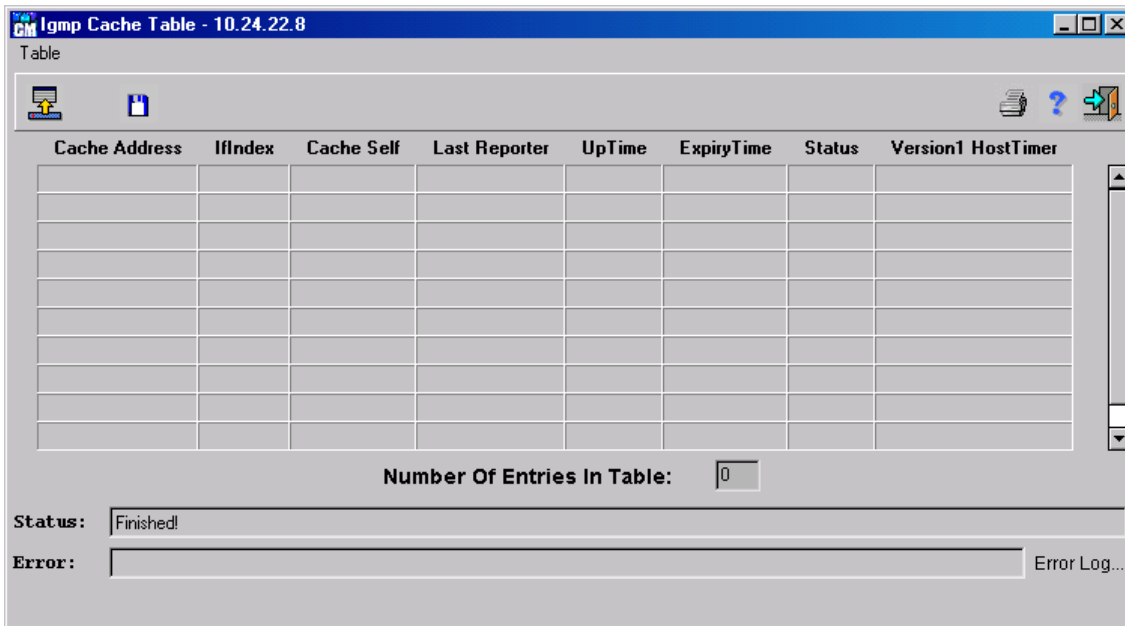

Figure 6- 134. IGMP Cache Table window

The **IGMP Cache Table** displays the following fields:

- ◆ **Cache Address** – Specifies the IP Multicast Group address to which the port is a member.
- ◆ **IfIndex** – Indicates the VLAN or port number.
- ◆ **Cache Self** – Indicates if the local system is a member of an IP Multicast Group address. If the entry is learned from a VLAN, the field specifies a physical port. If not the field entry is 0.
- ◆ **Last Reporter** – Identifies the last member to join the IP Multicast group. If no member has entered the IP Multicast group the value is 0.0.0.0.
- ◆ **UpTime** – Indicates in ticks the amount of time that has passed since the entry was created.
- ◆ **ExpiryTime** – Indicates the amount of time in ticks before the entry is aged out.
- ◆ **Status** – Indicates the status of the entry. The possible values are:
 - ◇ Active
 - ◇ Destructed
- ◆ **Version1 HostTimer** – Indicates the amount of time before the router assumes that there are no longer IGMP members on a subnet. If no IGMP group members are reported the Software version1 Host timer is reset.

Filter

The **Filter** menu has the following menu options:

- ◆ IGMP Filter Enable
- ◆ IGMP Filter Table

IGMP Filter Enable

The **IGMP Filter Enable** window allows you to enable or disable the IGMP filter.

To display the IGMP Filter Enable window:

- ◆ Select **Router > IPM > Filter > IGMP Filter Enable**. The **IGMP Filter Enable** opens:

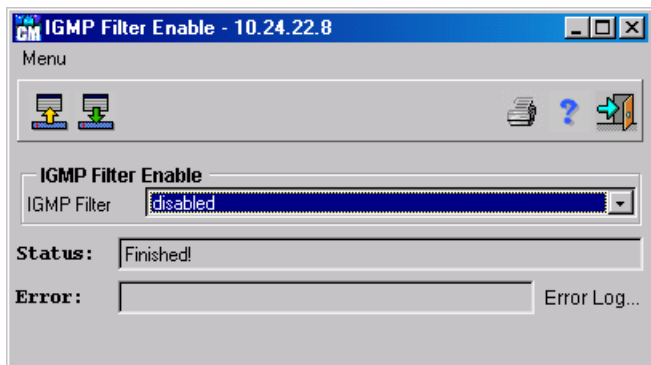

Figure 6- 135. IGMP Filter Enable window

The **IGMP Filter Enable** window displays the following field:

- ◆ **IGMP Filter** – Enables IGMP filtering on a device. *Disabled* is the default.

To enable IGMP filtering on a device:

1. Display the **IGMP Filter Enable** window.
2. Set the IGMP filtering status to *Enabled*.
3. Click to update the device. When the Status field displays “Finished!”, IGMP filtering is enabled on the device.

IGMP Filter Table

The **IGMP Filter Table** contains IGMP filter information for which IGMP is currently enabled.

To display the IGMP Filter Table:

- ◆ Select **Router > IPM > Filter > IGMP Filter Table**. The **IGMP Filter Table** opens:

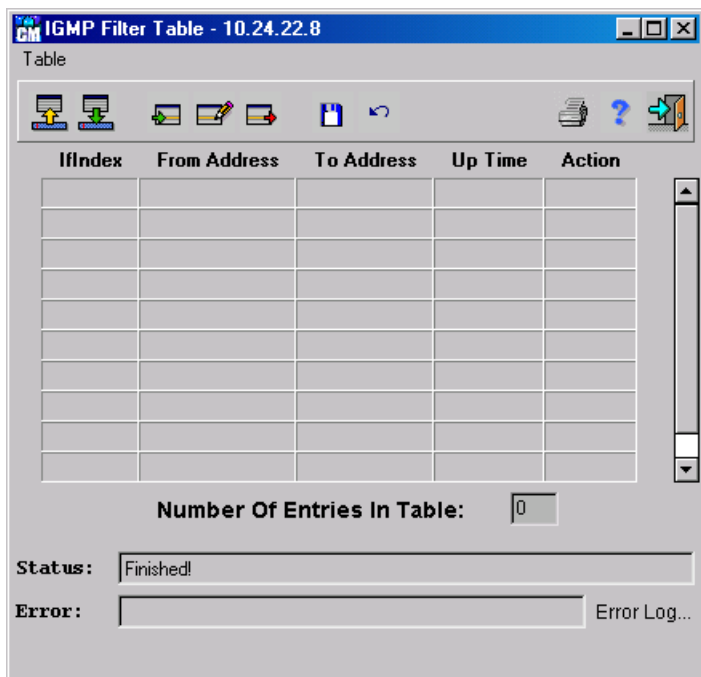

Figure 6- 136. IGMP Filter Table window

The **IGMP Filter Table** displays the following fields:

- ◆ **IfIndex** – Identifies the port number for which the IGMP filter is enabled.
- ◆ **From Address** – Indicates the IP address being filtered from.
- ◆ **To Address** – Indicates the IP address being filtered to.
- ◆ **Up Time** – Indicates in ticks the amount of time that has passed since the entry was created.
- ◆ **Action** – This parameter is used to fine-tune the IGMP filter.
 - ◇ Permit – Whether the indicated packets should be forwarded.
 - ◇ Deny – Whether the indicated packets should be blocked. .

To add an IGMP Filter entry:

1. Display the **IGMP Filter Table**.
2. Click . The **IGMP Filter Entry - Insert** window opens:

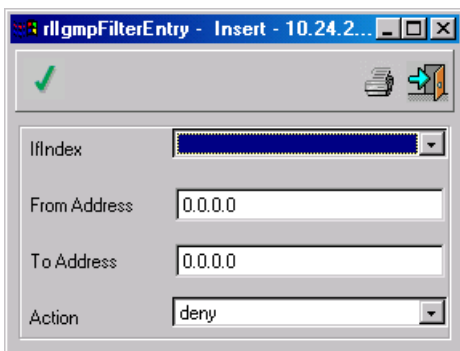





Figure 6- 137. IGMP Filter Entry - Insert window

3. Complete the fields. The fields are the same as the **IGMP Filter Table** as described above.
4. Click . The **IGMP Filter Entry - Insert** window closes.
5. Click  to update the device. When the Status field displays “Finished!” the IGMP information is saved to the device.

To edit an IGMP Filter entry:

1. Display the **IGMP Filter Table**.
2. Select an entry in the **IGMP Filter Table** and click . The **IGMP Filter Entry - Edit** window opens.

or

 Double-click a row in the **IGMP Filter Table**. The **IGMP Filter Entry - Edit** window opens:

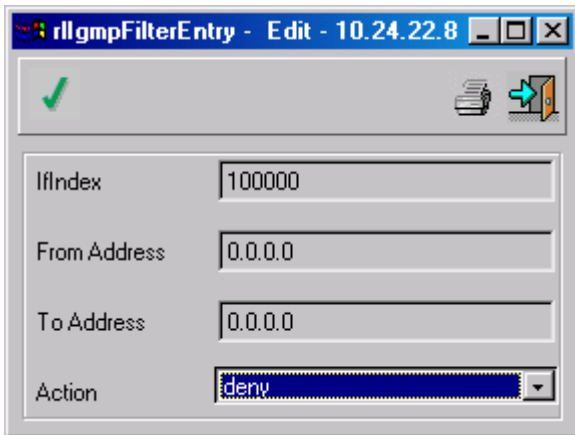





Figure 6- 138. IGMP Filter Entry - Edit window

3. Edit the fields. The fields are the same as the **IGMP Filter Table** as described above.
4. Click . The **IGMP Filter Entry - Edit** window closes.
5. Click . When the Status field displays “Finished!”, the IGMP filter information is saved to the device.

To delete an entry in the IGMP Filter Table:

1. Display the **IGMP Filter Table**.
2. Select an entry in the table.
3. Click . The entry is deleted from the **IGMP Filter Table**.
4. Click  to update the device. When the Status field displays “Finished!”, the entry is deleted from the device.

PIM

Multicast routers use Protocol Independent Multicast (PIM) to determine which other multicast routers should receive multicast packets. Protocol Independent Multicast-Dense Mode (PIM-DM) is used when there is a large population of receivers in a network. PIM-DM builds routing and forwarding tables on-the-fly. PIM-DM uses unicast routing information to provide routing table information and adapt to topological changes

The **PIM** menu has the following menu options:

- ◆ Parameters
- ◆ Interface Table
- ◆ Neighbor Table
- ◆ Route Table
- ◆ Route Next Hop

Parameters

The **PIM Parameters** window provides information regarding the PIM MIB software version currently being used for multicast routing.

To display the PIM Parameters window:

- ◆ Select **Router > IPM > PIM > Parameters**, the **PIM Parameters** window opens:

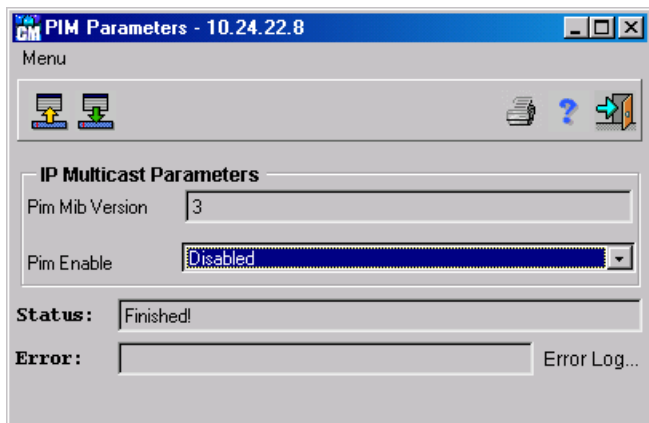

Figure 6- 139. PIM Parameters window

The **PIM Parameters** window displays the following fields:

- ◆ **PIM MIB Version** – Identifies the PIM MIB software version currently being used for multicast routing.
- ◆ **PIM Enable** – Indicates whether PIM is enabled or disabled.

PIM Interface Table

The **PIM Interface Table** contains an entry for each of the router's PIM ports. The **PIM Interface Table** lists the IPM multicast group members on specific ports.

To display the PIM Interface Table:

- ◆ Select **Router > IPM > PIM > Interface Table**, the **PIM Interface Table** window opens:

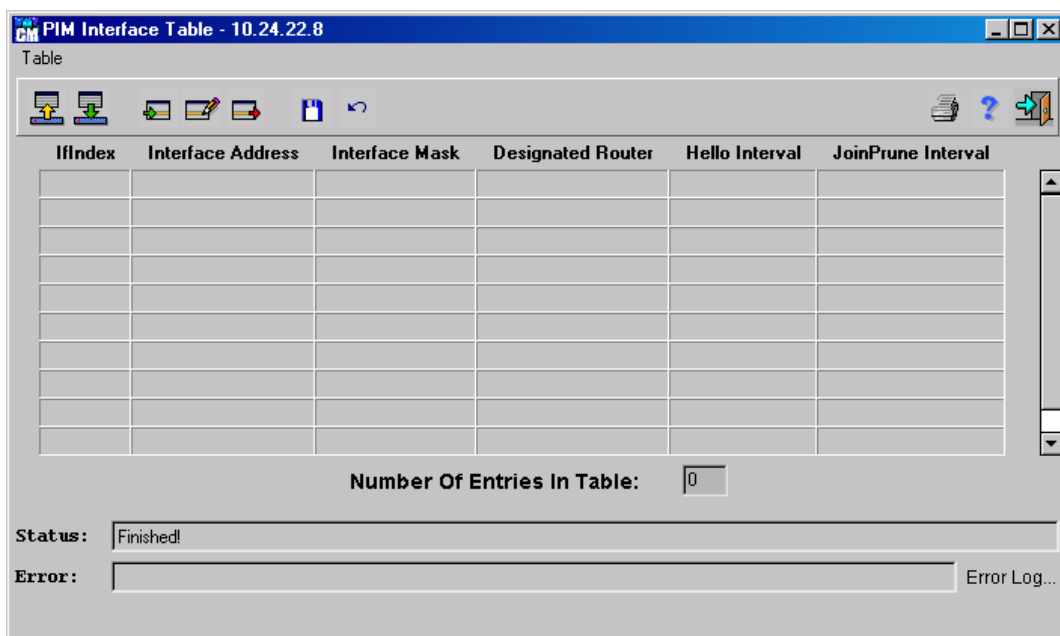

Figure 6- 140. PIM Interface Table window

The **PIM Interface Table** displays the following fields:

- ◆ **IfIndex** – Specifies the PIM port number.
- ◆ **Interface Address** – Indicates the IP address of the PIM port.

◆ **Interface Mask** – Masks all or part of the IP address of PIM ports.

◆ **Designated Router** – Identifies the designated router on each multi-access router. The designator router polls the LAN to determine group membership. The router with the highest IP address is the designated router. If the designated router times out, a new designated router is elected from the alternate PIM routers. Designated routers are only needed for multi-access networks and not point-to-point links. Point-to-point links show a value of 0.0.0.0.

◆ **Hello Interval** – Indicates in seconds the amount of time ports send hello messages. PIM-DM routers keep track of neighboring interfaces based on received hello messages. Neighbor information is deleted if there it is not refreshed before expiration. The default time is 30 seconds.

◆ **JoinPrune Intervals** – Indicates the intervals at which Join/Prune messages are sent to the PIM router. The PIM router assumes that all downstream routers can receive multicast packets, flooding the network with multicast packets. If specific network areas do not have multicast group members, PIM-DM prunes off the forwarding branch by establishing a Prune state. The Prune state contains the source and multicast group address, and contains a timer. When the timer expires the network branch goes into a forwarding state. The default is 210 seconds.

To add an PIM Interface Table entry:

1. Display the **PIM Interface Table**.
2. Click . **PIM Interface Table - Insert** window opens:

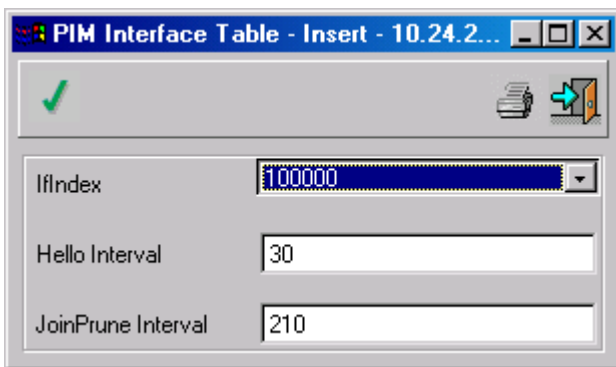





Figure 6- 141. PIM Interface Table – Insert window

3. Complete the fields. The fields are the same as the **PIM Interface Table** as described above.
4. Click . The **PIM Interface Table - Insert** window closes.
5. Click  to update the device. When the Status field displays “Finished!” the IGMP information is saved to the device.

To edit an PIM Interface Table entry:

Display the **PIM Interface Table**.

1. Select an entry in the PIM Interface Table and click .
2. The **PIM Interface Table - Edit** window opens.

or

Double-click a row in the **PIM Interface Table**. The **PIM Interface Table - Edit** window opens:

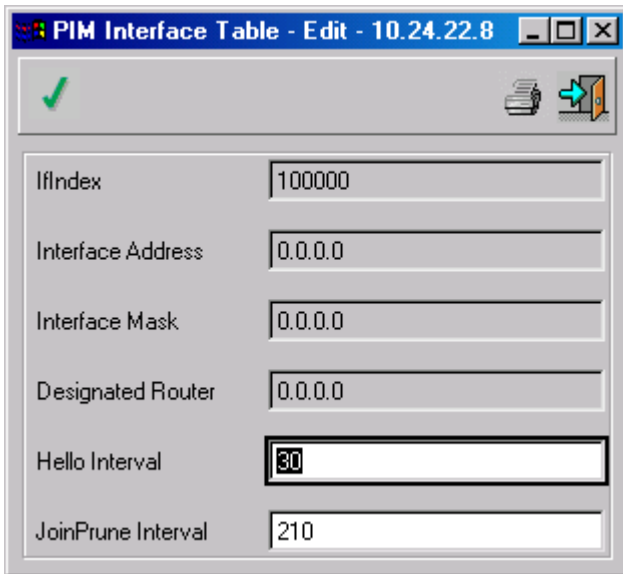





Figure 6- 142. PIM Interface Table - Edit window

3. Edit the fields. The fields are the same as the **PIM Interface Table** as described above.
4. Click . The **PIM Interface Table - Edit** window closes.
5. Click . When the Status field displays “Finished!”, the PIM information is saved to the device.

To delete an entry in the PIM Interface Table:

1. Display the **PIM Interface Table**.
2. Select an entry in the table.
3. Click . The entry is deleted from the **PIM Interface Table**.
4. Click  to update the device. When the Status field displays “Finished!”, the entry is deleted from the device.

PIM Neighbor Table

The **PIM Neighbor Table** contains information regarding each of a router's PIM neighbors.

To display the PIM Neighbor Table:

- ◆ Select **Router > IPM > PIM > Neighbor Table**, the **PIM Neighbor Table** window opens:

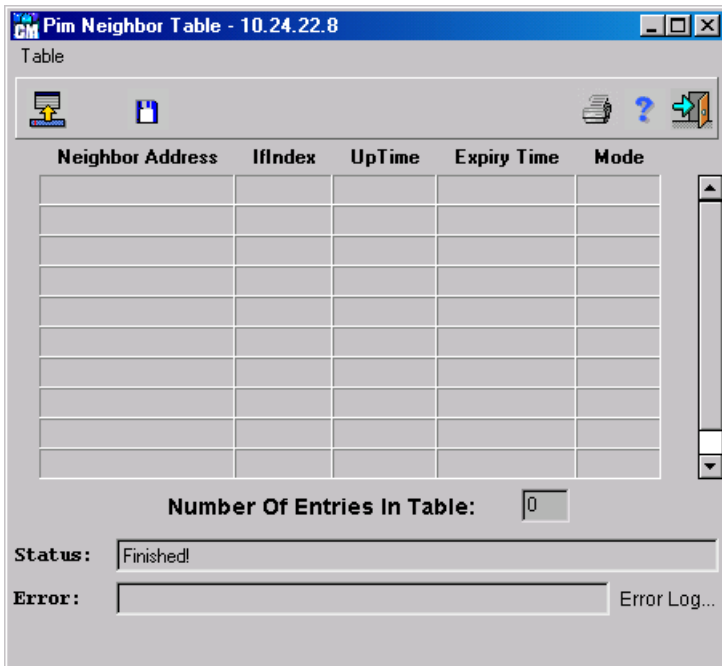

Figure 6- 143. PIM Neighbor Table window

The **PIM Neighbor Table** displays the following fields:

- ◆ **Neighbor Address** – Specifies the IP address of the PIM neighbor.
- ◆ **IfIndex** – Indicates the Port Number.
- ◆ **UpTime** – Indicates the time lapse since the PIM neighbor became the neighbor to the local router.
- ◆ **Expiry Time** – Indicates time in ticks before the PIM neighbor is aged out.
- ◆ **Mode** – Indicates the active PIM mode of the neighbor device. The possible value for this release is:
 - ◇ PIM-DM – The neighbor is currently operating in PIM-DM mode.

PIM Route Table

Multicast routing information is gathered and stored by PIM in the **PIM Route Table**. The **PIM Route Table** contains one row for each port in a PIM mode. Each routing entry contains information about the source and multicast group, and incoming and outgoing interfaces.

To display PIM Route Table:

- ◆ Select **Router > IPM > PIM > Route Table**, the **PIM Route Table** opens:

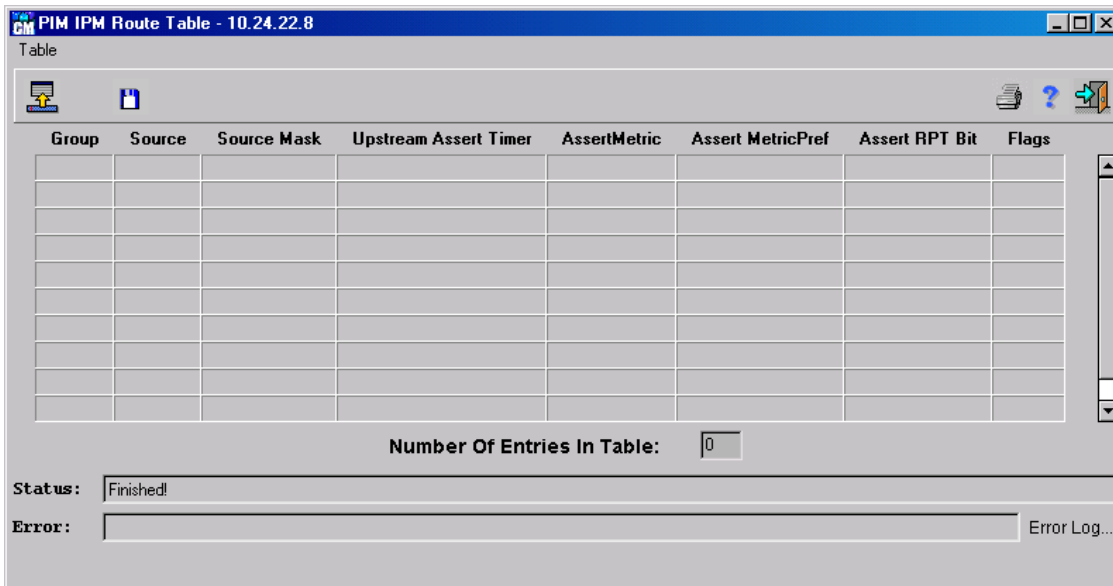

Figure 6-144. PIM IPM Route Table window

The **PIM IPM Route Table** displays the following fields:

- ◆ **Group** – Specifies the IP address of the multicast group. The range is 244.0.0.0-239.255.255.255.
- ◆ **Source** – Specifies the source IP address from where the multicast packets are being sent.
- ◆ **Source Mask** – Mask all or part of the source IP address.
- ◆ **Upstream Assert Timer** – Indicates the time before the router reverts from its upstream router to its RPF neighbor. When a multicast packet is received, the router sends an assert packet on a subnet indicating what metrics were used to reach the packet's source address. The router with the best metrics becomes the forwarding router. All other upstream routes are pruned. The downstream routers also compare if the RPF with the forwarding router. This ensures that the downstream routers send their prunes and grafts to the correct neighbor. The forwarding router sends an assert message to notify the other routers that it is the forwarding router. Downstream routers select the upstream router with the smallest metrics as their RPF neighbor. If two routers have the same metrics, the router with the highest IP address is chosen. When the assert timer expires, the downstream may switch from the forwarding router to a RPF neighbor. A value of 0 indicates that the assert has not changed the upstream neighbor to a RPF neighbor.
- ◆ **AssertMetric** – Specifies the metrics advertised by the forwarding router. A value of 0 indicates that no assert was received.
- ◆ **Assert MetricPref** – Indicates the preference advertised by the forwarding router on the upstream interface. Assert MetricPref is used when upstream routers are running different Unicast protocols. A value of 0 indicates that no assert is in effect.
- ◆ **Assert RPT Bit** – Indicates the value of the RPT bit advertised by the forwarding router
- ◆ **Flags** – Specifies the PIM-specific flags pertaining to the multicast state entry.

PIM IPM Route Next Hop

The **PIM IPM Route Next Hop** window contains the next-hops information of IP multicast packets. The **PIM IPM Route Next Hop** contains an entry for each outgoing interface listed in the multicast routing table running PIM, and whose state is pruned.

To display the PIM IPM Route Next Hop table:

- ◆ Select **Router > IPM > PIM > Route Next Hop**, the **PIM IPM Route Next Hop** window opens:

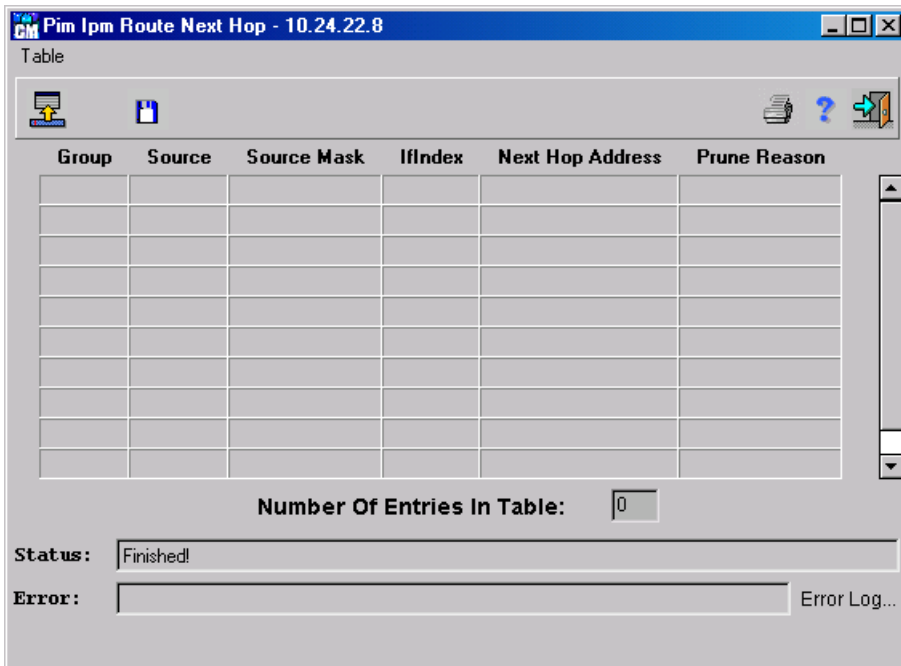

Figure 6- 145. PIM IPM Route Next Hop window

The **PIM IPM Route Next Hop** window displays the following fields:

- ◆ **Group** – Specifies the IP address of the next-hop multicast group.
- ◆ **Source** – Specifies the source IP address of the multicast packet.
- ◆ **Source Mask** – Masks all or part of the source IP address.
- ◆ **IfIndex** – Identifies the outgoing port.
- ◆ **Next Hop Address** – The IP address of the next-hop.
- ◆ **Prune Reason** – Indicates the reason the downstream interface was pruned. The possible values are:
 - ◇ Prune – Indicates that the downstream interface was pruned in response to a prune message.
 - ◇ Assert – Indicates that the downstream interface was pruned due to PIM assert processing.

IPM Routing

The **IPM Routing** menu has the following menu options:

- ◆ Route Table
- ◆ Route Next Hop Table

IPM Routing Table

The **IPM Routing Table** contain multicast routing information of IP packets sent from a specific source to IP multicast groups known to the IPM router.

To display the IPM Routing Table:

- ◆ Select **Router > IPM > IPM Routing > Route Table**. The **IPM Route Table** opens:

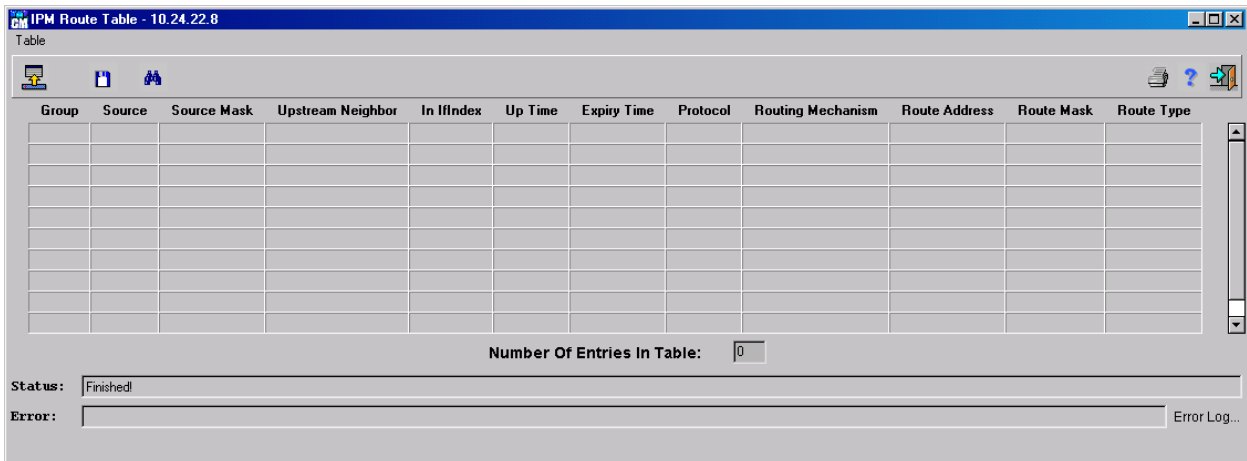

Figure 6- 146. IPM Route Table window

The **IPM Route Table** displays the following fields:

- ◆ **Group** – Identifies the IP address of the multicast group.
- ◆ **Source** – Identifies the source IP address of the device to which the multicast information applies.
- ◆ **Source Mask** – Masks all or parts of the source IP address.
- ◆ **Upstream Neighbor** – Specifies the IP address of the next upstream device from which packets to the IP address are received. The value 0.0.0.0 indicates that the value is unknown.
- ◆ **In IfIndex** – Indicates the port number to which multicast packets being sent are received. The value 0 indicates that incoming packets can be received on multiple interfaces.
- ◆ **Up Time** – Indicates the time lapse since the router learned the multicast information.
- ◆ **Expiry Time** – Indicates the time in ticks before the entry expires. A value of 0 indicates that the entry has not expired.
- ◆ **Protocol** – Identifies the type of protocol used to learn the multicast information. The possible values are:
 - ◇ Other – Indicates that none of the below listed protocols are used to learn multicast forwarding information.
 - ◇ Local – Indicates that a manually configured protocol was used to learn the multicast information.
 - ◇ Netmgmt – Indicates that the Network Management Protocol was used to learn the multicast information.
 - ◇ DVMRP – Indicates that the Distance Vector Multicast Routing Protocol was used to learn the multicast information.
 - ◇ MOSPF – Indicates that Multicast extended OSPF was used to learn the multicast information.
 - ◇ PIMSparseDense – Indicates that Protocol Independent Multicast was used to learn the multicast information.
 - ◇ CBT – Indicates that CBT was used to learn the multicast information.
 - ◇ PIM-SM – Indicates that Protocol Independent Multicast-Sparce Mode was used to learned the multicast information.
 - ◇ PIM-DM – Indicates that Protocol Independent Multicast-Dense Mode was used to learned the multicast information.

- ◇ IGMP – Indicates that the Internet Group Multicast Protocol was used to learn the multicast information.
- ◇ BGMP – Indicates that the Border Gateway Multicast Protocol was used to learn this entry's multicast information.
- ◇ MSDP – Indicates that the Multicast Source Discovery Protocol was used to learn the multicast information.
- ◆ **Routing Mechanism** – Identifies the routing mechanism used to find the next upstream or parent interface which provided the multicast information. The possible values are:
 - ◇ Other – Indicates that none of the below listed protocols are used to find the next upstream or parent interface of the multicast information.
 - ◇ Local – Indicates that a manually configured protocol was used to find the next upstream or parent interface of the multicast information.
 - ◇ Netmgmt – Indicates that the Network Management Protocol was used to find the next upstream or parent interface of the multicast information. This route is static.
 - ◇ ICMP – Indicates that the Internet Control Message Protocol was used to find the next upstream or parent interface for the multicast information.
 - ◇ RIP – Indicates that the Routing Information Protocol was used to find the next upstream or parent interface of the multicast information.
 - ◇ OSPF – Indicates that the Open First Path First Protocol was used to find the next upstream or parent interface of the multicast information.
 - ◇ BGP – Indicates that the Border Gateway Protocol was used to find the next upstream or parent interface of the multicast information.
 - ◇ DVRMP – Indicates that the Internet Control Message Protocol was used to find the next upstream or parent interface of the multicast information.
- ◆ **Route Address** – Identifies the IP address used to find the upstream or parent interface of the multicast information.
- ◆ **Route Mask** – Masks all or part of the IP addresses used to find the upstream or parent interface of the multicast information.
- ◆ **Route Type** – Indicates if the route was a unicast or multicast route. The possible values are:
 - ◇ Unicast – Indicates that the route was placed in the multicast routing information base (RIB) either instead of or in addition to unicast RIB by a local configuration, for example when running PIM over RIP.
 - ◇ Multicast – Indicates that the route was explicitly added to the multicast RIB by the routing protocol.

IPM Route Next Hop

The **IPM Route Next Hop** window contains information regarding the next-hop for forwarding multicast packets on outgoing interfaces. Each entry in the **IPM Route Next Hop** table refers to the next-hop of a specific source to a specific multicast group address.

To display the IPM Route Next Hop table:

- ◆ Select **Router > IPM > IPM Routing > Route Next Hop Table**. The **IPM Route Next Hop table** opens:

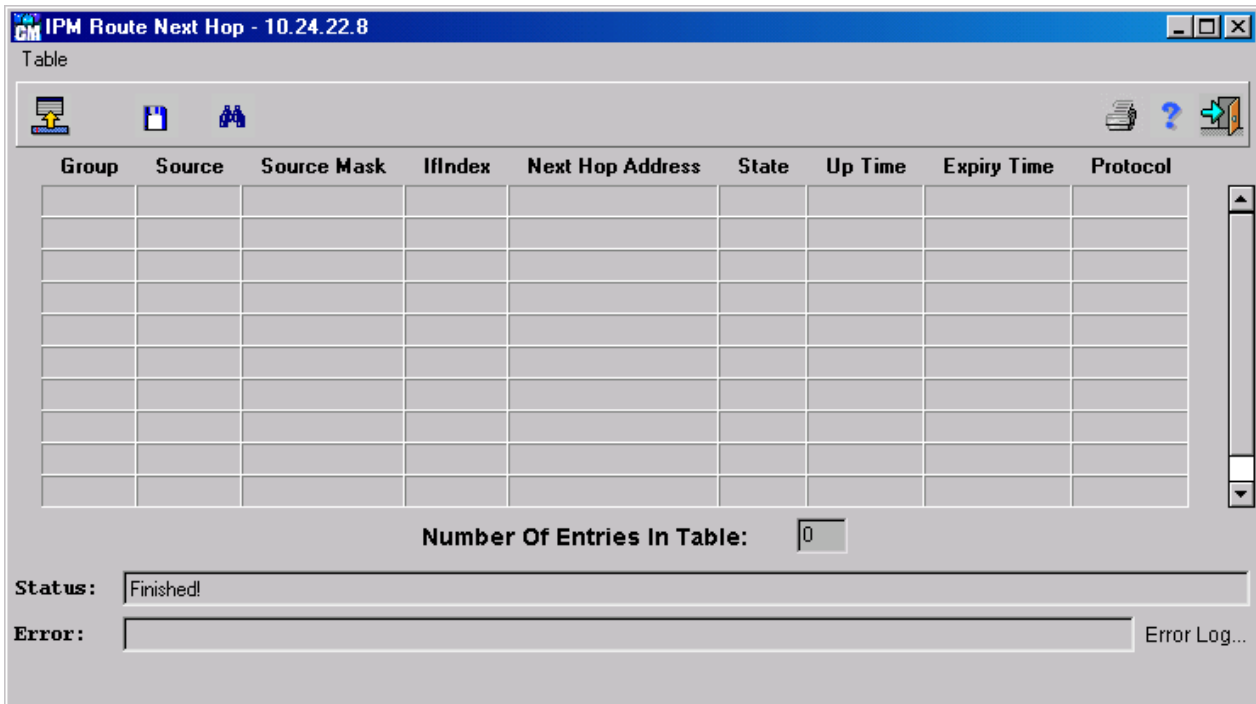

Figure 6- 147. IPM Route Next Hop window

The **IPM Route Next Hop** window displays the following fields:

- ◆ **Group** – Identifies the IP multicast group from which the multicast packet is being forwarded.
- ◆ **Source** – Identifies the source IP address of the multicast packet being forwarded.
- ◆ **Source Mask** – Masks all or part of the source IP address.
- ◆ **IfIndex** – Identifies the port number of the next-hop.
- ◆ **Next Hop Address** – Indicates the IP addresses of the next-hop. This may be identical to the Group value. However, some ports may have multiple next-hop addresses from a single outgoing interface.
- ◆ **State** – Indicates if the port and next-hop are being used to forward multicast packets. The possible values are:
 - ◇ Pruned – The port and next hop are not being used to forward multicast packets
 - ◇ Forwarding – The port and the next hop are currently being used to forward multicast packets.
- ◆ **Up Time** – Indicates the time lapse since the router learned the multicast information.
- ◆ **Expiry Time** – Indicates the time in ticks before the entry expires. A value of 0 indicates that the entry is not expired. However, if the Hop Status is *Pruned*, the value indicates the amount of time remaining before the port and next hop revert to *Forwarding*.
- ◆ **Protocol** – Identifies the routing protocol used to find the next hop. The possible values are:
 - ◇ Other – Indicates that none of the below listed protocols are used to find the next upstream or parent interface for the next-hop.
 - ◇ Local – Indicates that a manually configured protocol was used to find the next upstream or parent interface for the next-hop.
 - ◇ Netmgmt – Indicates that the Network Management Protocol was used to find the next upstream or parent interface for the next-hop. This route is static.

- ◇ ICMP – Indicates that the Internet Control Message Protocol was used to find the next upstream or parent interface for the next-hop.
- ◇ RIP – Indicates that the Routing Information Protocol was used to find the next upstream or parent interface for the next-hop.
- ◇ OSPF – Indicates that the Open First Path First Protocol was used to find the next upstream or parent interface for the next-hop.
- ◇ BGP – Indicates that the Border Gateway Protocol was used to find the next upstream or parent interface for the next-hop.
- ◇ DVRMP – Indicates that the Internet Control Message Protocol was used to find the next upstream or parent interface for the next-hop.

IPX

The **IPX** menu has the following menu options:

- ◆ Interface Parameters
- ◆ RIP/SAP Filter
- ◆ Routing Table
- ◆ SAP Table

Interface Parameters

To display the IPX Router Interface Parameters window:

- ◆ Select **Router > IPX > Interface Parameters**. The **IPX Router Interface Parameters** window opens:

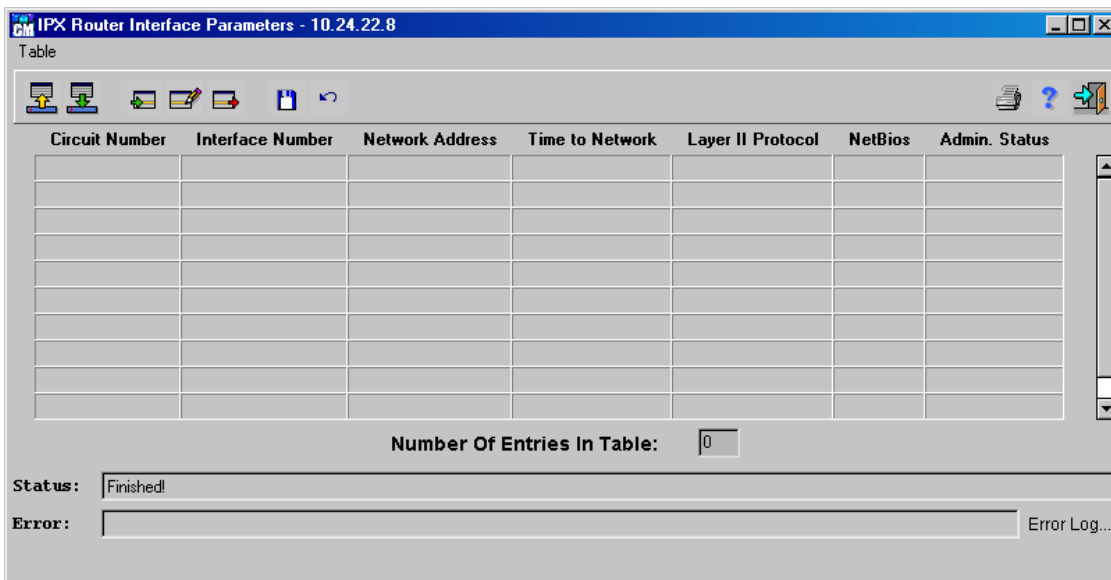

Figure 6- 148. IPX Router Interface Parameters window

The **IPX Router Interface Parameters** window displays the following parameters:

- ◆ **Circuit Number** – IPX circuit number.
- ◆ **Interface Number** – The IF Index used by this circuit.
- ◆ **Network Address** – IPX network address of this circuit.
- ◆ **Time To Network** – Time to net value associated with this interface, in 1/18ths of a second.

- ◆ **Layer II Protocol** – Encapsulation method associated with this interface. If the Interface Number refers to a VLAN, this must be the same encapsulation as used by the VLAN.
- ◆ **NetBios** – NetBios type 20 broadcast packets are forwarded to this interface.
- ◆ **Admin Status** – Indicates whether this circuit entry is valid, or Sleeping (currently inactive).

To add an IPX Router Interface entry:

1. Display the **IPX Router Interface Parameters** window.
2. Click . The **IPX Router Interface Parameters Insert** window opens:

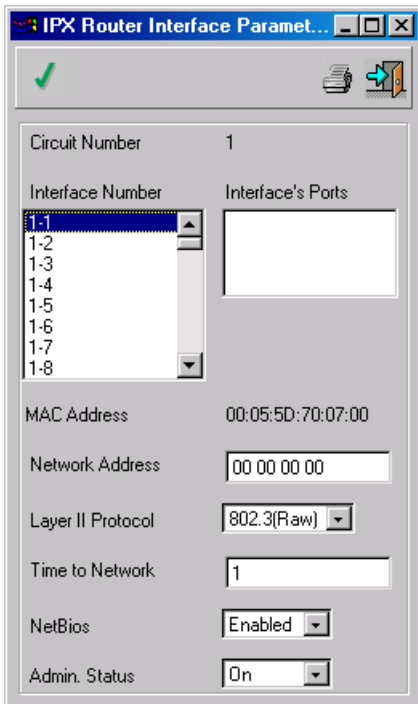





Figure 6- 149. IPX Router Interface Parameters Insert window

3. Complete the fields.
4. Click .
5. Close the **IPX Router Interface Parameters Insert** window. The **IPX Router Interface Parameters** window opens.
6. Click . When the Status field displays “Finished!”, the fields are confirmed as modified.

To edit an IPX Router Interface entry:

1. Display the **IPX Router Interface Parameters** window.
2. Select an entry in the table.
3. Click . The **IPX Router Interface Parameters Edit** window opens:

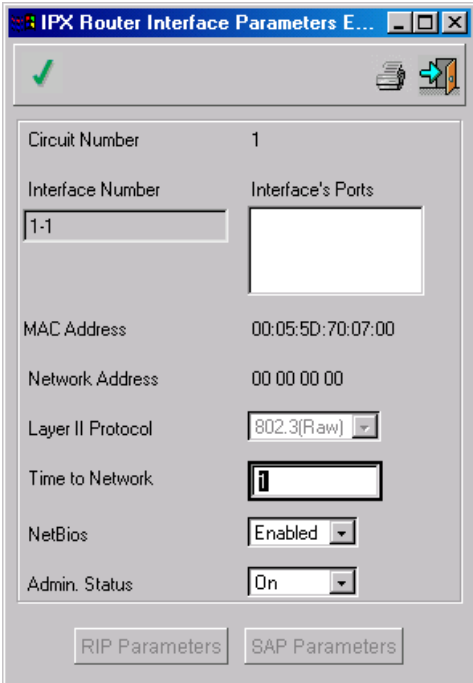

Figure 6- 150. IPX Router Interface Parameters Edit window

4. Click the **RIP Parameters** button to modify IPX RIP parameters. The **IPX RIP Parameters** window opens:

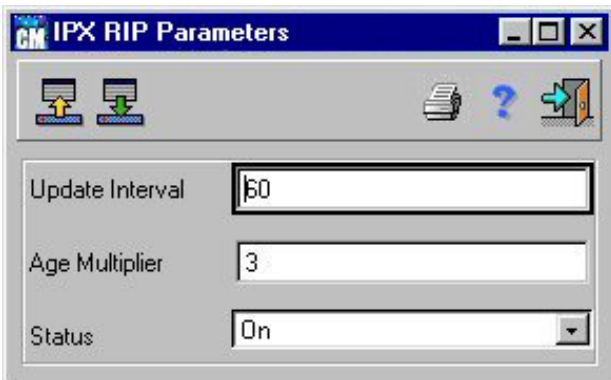



Figure 6- 151. IPX RIP Parameters window

The **IPX RIP Parameters** window displays the following parameters:

- ◆ **Update Interval** – RIP periodic update interval, in seconds. Set to 0 to disable periodic messages. When set to 0, all entries learned on this interface are not aged out.
- ◆ **Age Multiplier** – Holding multiplier for information received in RIP periodic updates. This value multiplied by the update interval defines how many seconds RIP information remains without being refreshed. Set to 0 to prevent the entries learned on this interface from being aged out.
- ◆ **Status** – Whether the RIP interface is active. *OFF* is inactive but not deleted.

Note: *The Update Interval multiplied by the Age Multiplier must be less than 2 million.*

1. Complete the **IPX RIP Parameters** window fields if required.
2. Click . Close the **IPX RIP Parameters** window. The **IPX Router Interface Parameters Edit** window opens.

- Click the **SAP Parameters** button to modify IPX SAP parameters. The **IPX SAP Parameters** window opens:

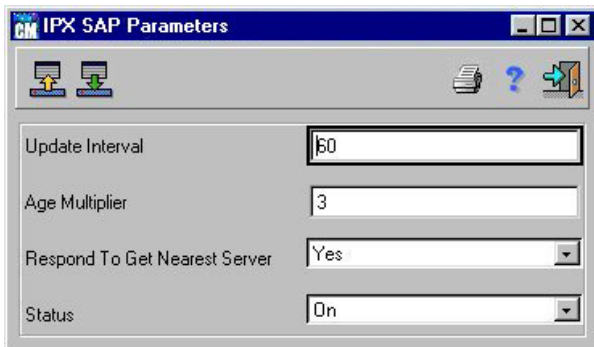



Figure 6- 152. IPX SAP Parameters window



The **IPX SAP Parameters** window displays the following parameters:

- ◆ **Update Interval** – SAP periodic update interval, in seconds. Set to 0 to disable periodic messages. When set to 0, all entries learned on this interface are not aged out.
- ◆ **Age Multiplier** – Holding multiplier for information received in SAP periodic updates. This value multiplied by the update interval defines how many seconds SAP information remains without being refreshed. Set to 0 to prevent the entries learned on this interface from being aged out.
- ◆ **Respond to Get Nearest Server** – Defines whether the device responds to SAP “get nearest server” requests received on this circuit.
- ◆ **Status** – Defines whether the SAP interface is active. OFF is inactive but not deleted.

Note: The Update Interval multiplied by the Age Multiplier must be less than 2 million.

- Complete the **IPX SAP Parameters** window fields if required.
- Click. Close the **IPX SAP Parameters** window. The **IPX Router Interface Parameters Edit** window is displayed.
- Edit the fields.
- Click .
- Close the **IPX Router Interface Parameters Edit** window. The **IPX Router Interface Parameters** window opens.
- Click . When the Status field displays “Finished!”, the fields are confirmed as modified.

To delete an IPX Router Interface entry:

- Display the **IPX Router Interface Parameters** window.
- Select an entry in the table.
- Click . The entry is deleted.
- Click . When the Status field displays “Finished!”, the fields are confirmed as modified.

RIP/SAP Filter

The **IPX RIP / SAP Filter** table is used to display both global and circuit (IPX interface-specific) filters, for both RIP and SAP. Circuit filters take precedence over global filters. To display the **IPX RIP / SAP Filter** table:

- ◆ Select **Router > IPX > RIP / SAP Filter**. The **IPX RIP / SAP Filter** window opens:

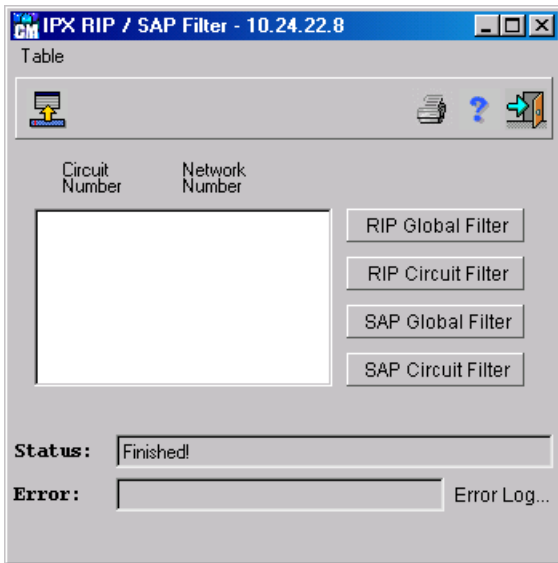

Figure 6- 153. IPX RIP/SAP Filter window

The **IPX RIP/SAP Filter** window contains the following buttons that allow you to define additional parameters:

- ◆ **RIP Global Filter** – Defines the type of traffic that the filter applies to, the network addresses the filter affects, network masks, and action taken on a packet.
- ◆ **RIP Circuit Filter** – Defines the type of traffic that the filter applies to, the network addresses the filter affects, network masks, and action taken on a packet.
- ◆ **SAP Global Filter** – Defines the type of traffic that the filter applies to, the network addresses the filter affects, network masks, the service type, and action taken on a packet.
- ◆ **SAP Circuit Filter** – Defines the type of traffic that the filter applies to, the network addresses the filter affects, network masks, the service type, and action taken on a packet.

Press the **RIP Global Filter** button and complete the **RIP Global Filter** table fields.

Press the **RIP Circuit Filter** button and complete the **RIP Global Circuit Fields** window fields.

Press the **SAP Global Filter** button and complete the **SAP Global Filter** table fields.

Press the **SAP Circuit Filter** button and complete the **SAP Global Circuit Fields** window fields.

To display the RIP Global Filter Table:

1. Display the **IPX RIP/SAP Filter** window.
2. Press the **RIP Global Filter** button. The **RIP Global Filter Table** opens:

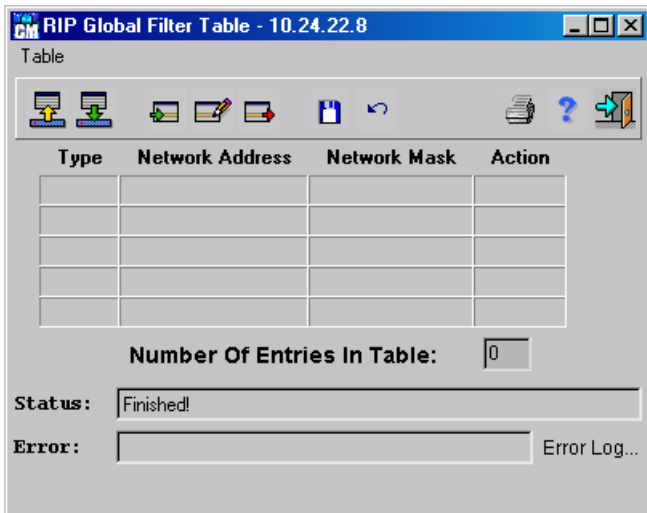

Figure 6- 154. RIP Global Filter Table window

The **RIP Global Filter Table** displays the following parameters:

- ◆ **Type** – Defines whether the current filter entry works on traffic coming into or out of the device.
- ◆ **Network Address** – Type in the network pattern the filter entry is to affect. The network pattern works in conjunction with the network mask to define the filter entry.
- ◆ **Network Mask** – Type in the letters F, 8, C, E, and 0 as many times as desired to indicate which network pattern part is important. The mask must be continuous from left to right. 00000000 means all addresses, ffffffff means one address (no address range). A combination of fs and Os indicates a specific range. This combination must have f on the left side, 0 on the right side, and a single F, 8, C, or E, or 0 between them.

For example, if the network pattern is set to 12345678, the network mask can be set to ffff0000. This indicates that only the first four network pattern numbers are checked, and the remaining numbers are irrelevant. In this example, only RIP messages with the numbers 1234 as their first four digits are affected.

- ◆ **Action** – Defines whether the indicated packets are forwarded (permit) or blocked (denied) when the current filter entry conditions are met. The parameter is used to fine-tune other filter entries.

For example, set a filter entry to block all RIP messages with a network pattern starting with 123, and set another filter entry to permit all RIP messages with a network pattern starting with 1234. As a result, all RIP messages with a network pattern starting with 123 that do not have 4 as the fourth digit are blocked.

The default is forward, but the default can be set by creating a general filter entry with the network mask 00000000, and setting it to permit or deny.

To add a RIP Global filter:

1. Display the **RIP Global Filter Table**.
2. Click . The **RIP Global Filter Insert** window opens:

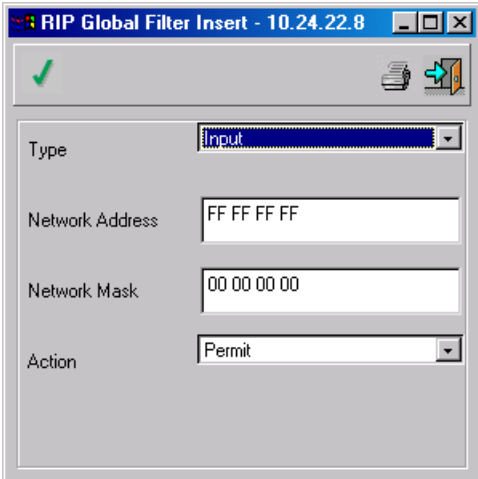





Figure 6- 155. RIP Global Filter Insert window

3. Complete the fields.
4. Click .
5. Close the **RIP Global Filter Insert** window. The **RIP Global Filter Table** opens.
6. Click . When the Status field displays “Finished!”, the fields are confirmed as modified.

To edit a RIP Global filter:

1. Display the **RIP Global Filter Table**.
2. Select an entry in the table.
3. Click . The **RIP Global Filter Edit** window opens:

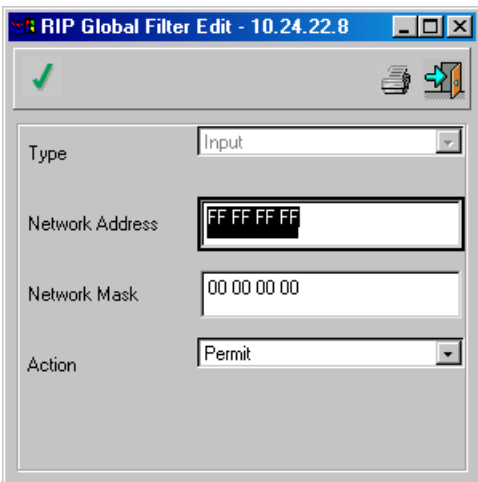





Figure 6- 156. RIP Global Filter Edit window

4. Complete the fields.
5. Click .
6. Close the **RIP Global Filter Edit** window. The **RIP Global Filter Table** opens.
7. Click . When the Status field displays “Finished!”, the fields are confirmed as modified.

To delete a RIP Global filter:

1. Display the **RIP Global Filter Table**.
2. Select an entry in the table.
3. Click . The entry is deleted.
4. Click . When the Status field displays "Finished!", the fields are confirmed as modified.

To display the RIP Circuit Filter Table:

1. Display the **IPX RIP/SAP Filter** window.
2. Press the **RIP Circuit Filter** button. The **RIP Circuit Filter Table** opens:

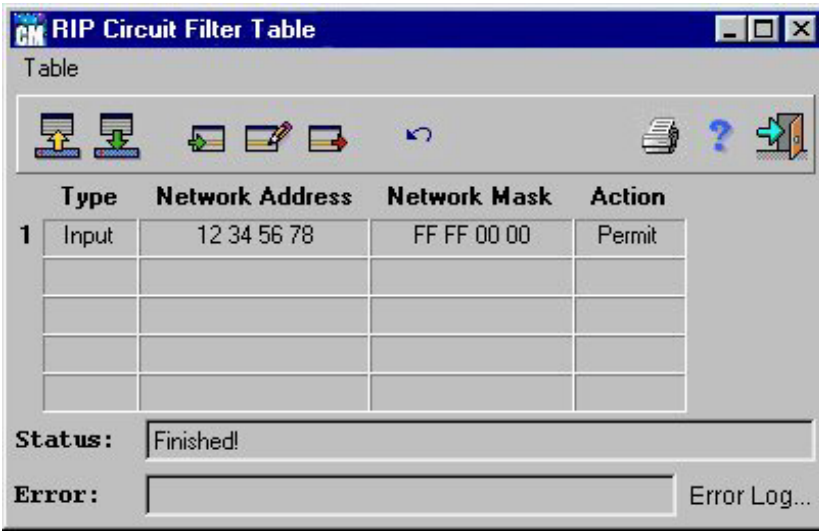

Figure 6- 157. RIP Circuit Filter Table window

The **RIP Circuit Filter Table** displays the following parameters:

- ◆ **Type** – Defines whether the current filter entry works on traffic coming into or out of the device.
- ◆ **Network Address** – The network pattern to affect the filter entry. The network pattern works in conjunction with the network mask to define the filter entry.
- ◆ **Network Mask** – Type in the letters F, 8, C, E, and 0 as many times as desired to indicate which part of the network pattern is important. The mask must be continuous from left to right. 00000000 means all addresses, ffffffff means one address (no address range). A combination of f 0 indicates a specific range. This combination must have f on the left side, 0 on the right side, and a single F, 8, C, or E, or 0 between them.

For example, if the network pattern is set to 12345678, set the network mask to ffff0000 to indicate that only the first four numbers of the network pattern are checked, and the remaining numbers are irrelevant. In this example, only RIP messages with the numbers 1234 as their first four digits are affected.

- ◆ **Action** – Defines whether the indicated packets are forwarded (permit) or blocked (denied) when the current filter entry conditions are met. This parameter can be used to fine-tune other filter entries. For example, a filter entry can be set to block all RIP messages with a network pattern starting with 123, and set another filter entry to permit all RIP messages with a network pattern starting with 1234. As a result, all RIP messages with a network pattern starting with 123 that do not have 4 as the fourth digit are blocked.

To add a RIP Circuit filter:

1. Display the **RIP Circuit Filter Table**.

2. Click . The **RIP Circuit Filter Insert** window opens:

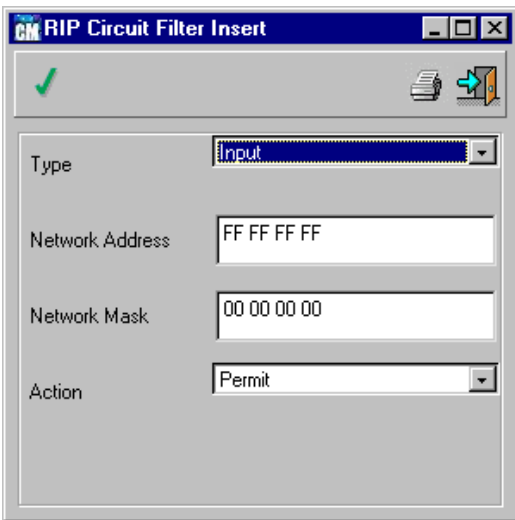





Figure 6- 158. RIP Circuit Filter Insert window

3. Complete the fields.
4. Click .
5. Close the **RIP Circuit Filter Insert** window. The **RIP Circuit Filter Table** opens.
6. Click . When the Status field displays “Finished!”, the fields are confirmed as modified.

To edit a RIP Circuit filter:

1. Display the **RIP Circuit Filter Table**.
2. Select an entry in the table.
3. Click . The **RIP Circuit Filter Edit** window opens:

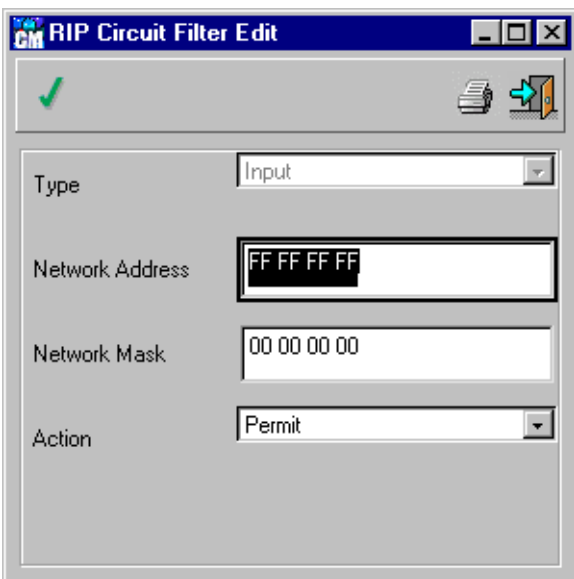





Figure 6- 159. RIP Circuit Filter Edit window

4. Complete the fields.

5. Click .
6. Close the **RIP Circuit Filter Edit** window. The **RIP Circuit Filter Table** opens.
7. Click . When the Status field displays “Finished!”, the fields are confirmed as modified.

To delete a RIP Circuit filter:

1. Display the **RIP Circuit Filter Table**.
2. Select an entry in the table.
3. Click . The filter is deleted.
4. Click . When the Status field displays “Finished!”, the fields are confirmed as modified.

To display the SAP Global Filters:

1. Display the **IPX RIP/SAP Filter** window.
2. Press the **SAP Global Filter** button. The **SAP Global Filter Table** opens:

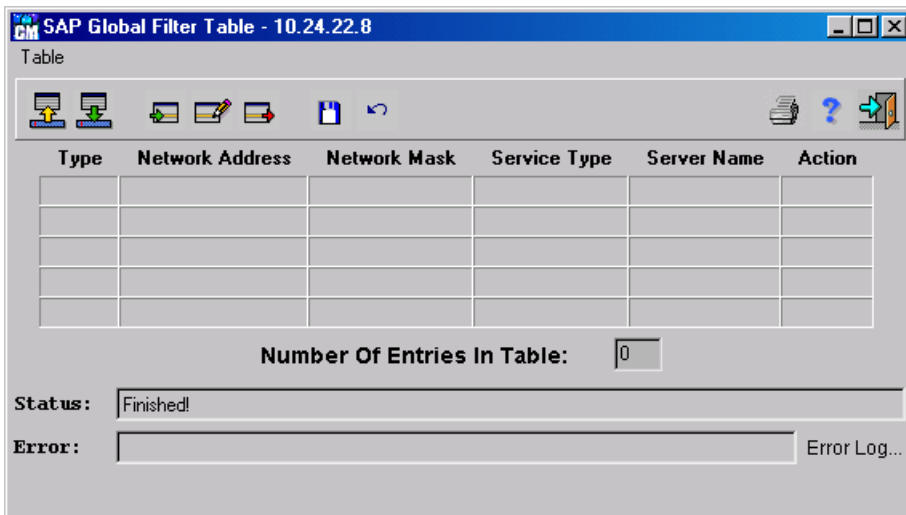

Figure 6- 160. SAP Global Filter Table window

The **SAP Global Filter Table** displays the following parameters:

- ◆ **Type** – Defines whether the current filter entry works on traffic coming into or out of the device.
- ◆ **Network Address** – Type in the network pattern to affect the filter entry. The network pattern works in conjunction with the network mask to define the filter entry.
- ◆ **Network Mask** – Type in the letters F, 8, C, E, and 0 as many times as desired to indicate which part of the network pattern is important. The mask must be continuous from left to right. 00000000 means all addresses, fffffff means one address (no address range). A combination of f 0 indicates a specific range. This combination must have f on the left side, 0 on the right side, and a single F, 8, C, or E, or 0 between them.

For example, if the network pattern is set to 12345678, the network mask can be set to ffff0000 to indicate that only the first four numbers of the network pattern are only checked, and the remaining numbers are irrelevant. In this example, only SAP messages with the numbers 1234 as their first four digits are affected.

- ◆ **Service Type** – Type in the type of server (in hex) the filter entry affects, such as file server or print server. Value 0xFFFF applies for all types of service and is the default.

◆ **Service Name** – Type in the server name the filter entry affects. An asterisk (*) at the end of the name as a wildcard designates any number of characters.

For example, * indicates any server name, and sh* indicates any server name starting with sh. The name may be up to 47 characters.

◆ **Action** – Defines whether the indicated packets are to be forwarded (permit) or blocked (denied) when the current filter entry conditions are met. This parameter is used to fine-tune other filter entries.

For example, a filter entry can be set to block all SAP messages with a network pattern starting with 123, and set another filter entry to permit all SAP messages with a network pattern starting with 1234. all SAP messages with a network pattern starting with 123 that do not have 4 as the fourth digit are blocked.

The default is forward, but the default can be set by creating a general filter entry with the network mask 00000000, and setting it to permit or deny.

To add a SAP Global filter:

1. Display the **SAP Global Filter Table**.
2. Click . The **SAP Global Filter Insert** window opens:

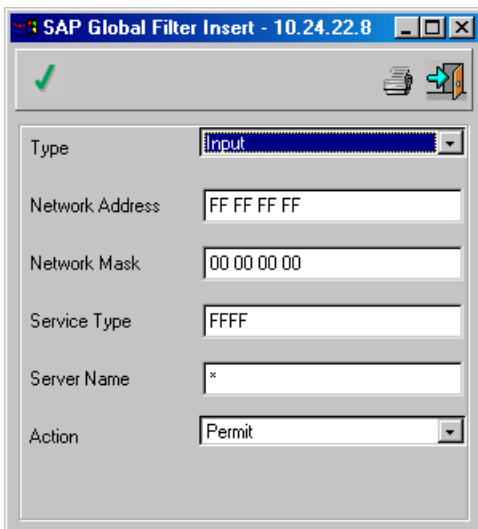





Figure 6- 161. SAP Global Filter Insert window

3. Complete the fields.
4. Click .
5. Close the **SAP Global Filter Insert** window. The **SAP Global Filter Table** opens.
6. Click . When the Status field displays “Finished!”, the fields are confirmed as modified.

To edit a SAP Global filter:

1. Display the **SAP Global Filter Table**.
2. Select an entry in the table.
3. Click . The **SAP Global Filter Edit** window opens:

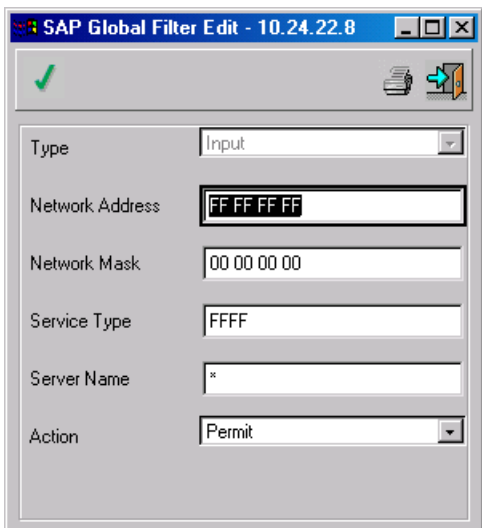





Figure 6- 162. SAP Global Filter Edit window

4. Edit the fields.
5. Click .
6. Close the **SAP Global Filter Edit** window. The **SAP Global Filter Table** opens.
7. Click . When the Status field displays “Finished!”, the fields are confirmed as modified.

To delete a SAP Global filter:

1. Display the **SAP Global Filter Table**.
2. Select an entry in the table.
3. Click . The filter is deleted.
4. Click . When the Status field displays “Finished!”, the fields are confirmed as modified.

To display the SAP Circuit Filters:

1. Display the **IPX RIP/SAP Filter** window.
2. Press the **SAP Circuit Filter** button. The **SAP Circuit Filter Table** opens:

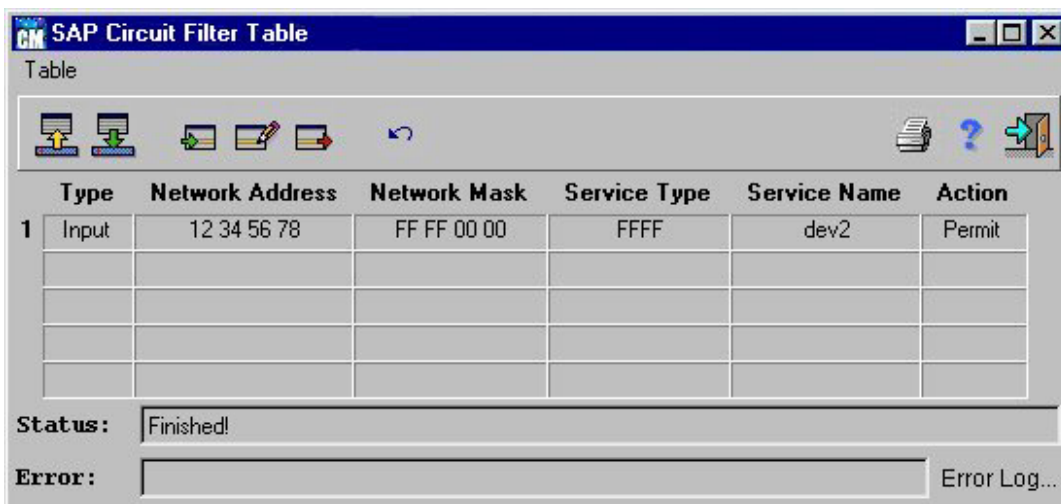

Figure 6- 163. SAP Circuit Filter Table window

The **SAP Circuit Filter Table** displays the following parameters:

◆ **Type** – Defines whether the current filter entry works on traffic coming into or out of the device.

◆ **Network Address** – The network pattern the filter entry affects. The network pattern works in conjunction with the network mask to define the filter entry.

◆ **Network Mask** – Type in the letters F, 8, C, E, and 0 as many times as desired to indicate which part of the network pattern is important. The mask must be continuous from left to right. 00000000 means all addresses, ffffffff means one address (no address range). A combination of f 0 indicates a specific range. This combination must have f on the left side, 0 on the right side, and a single F, 8, C, or E, or 0 between them.

For example, if the network pattern is set to 12345678, set the network mask to ffff0000 to indicate that only the first four numbers of the network pattern are checked, and the remaining numbers are irrelevant. In this example, only RIP messages with the numbers 1234 as their first four digits are affected.

◆ **Service Type** – Type in the type of server (in hex) the filter entry affects, such as file server or print server. Value 0xFFFF applies for all types of service and is the default.

◆ **Service Name** – Type in the server name the filter entry affects. An asterisk (*) at the end of the name as a wildcard, designating any number of characters.

For example, * indicates any server name, and **sh*** indicates any server name starting with **sh**. The name may be up to 47 characters.

◆ **Action** – Defines whether the indicated packets are to be forwarded (permit) or blocked (denied) when the current filter entry conditions are met. This parameter can be used to fine-tune other filter entries. For example, a filter entry can be set to block all SAP messages with a network pattern starting with 123, and set another filter entry to permit all SAP messages with a network pattern starting with 1234. As a result, all SAP messages with a network pattern starting with 123 that do not have 4 as the fourth digit are blocked.

The default is forward, but the default can be set by creating a general filter entry with the network mask 00000000, and setting it to permit or deny.

To add a SAP Circuit filter:

1. Display the **SAP Circuit Filter Table**.
2. Click . The **SAP Circuit Filter Insert** window opens:

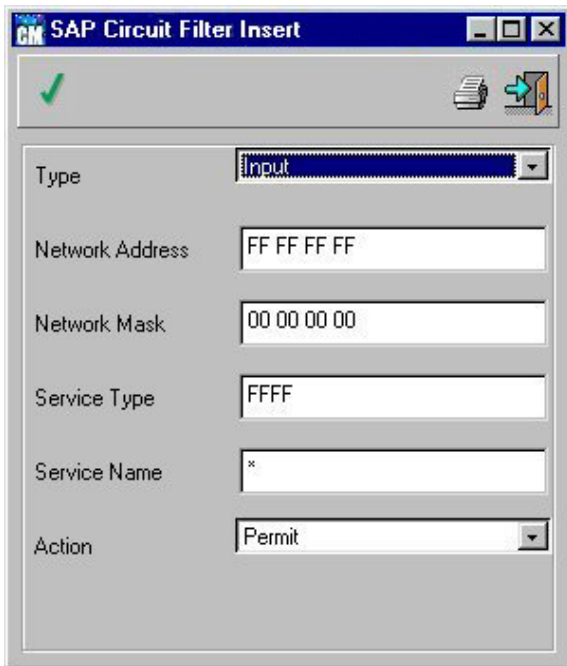



Figure 6- 164. SAP Circuit Filter Insert window

3. Complete the fields. For the field Service Name – Select either ASCII or Hex
4. Click .
5. Close the **SAP Circuit Filter Insert** window. The **SAP Circuit Filter Table** opens.
6. Click . When the Status field displays Finished!, the fields are confirmed as modified.

To edit a SAP Circuit filter:

1. Display the **SAP Circuit Filter Table**.
2. Select an entry in the table.
3. Click . The **SAP Global Filter Edit** window opens:

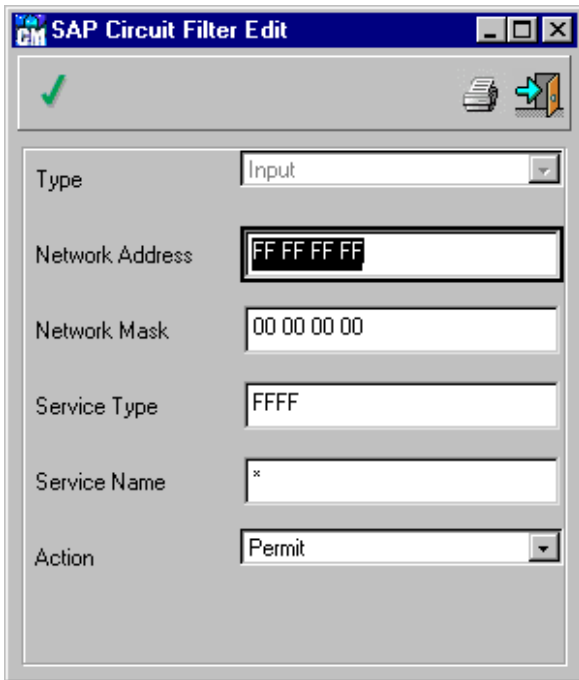





Figure 6- 165. SAP Circuit Filter Edit window

4. Edit the fields.
5. Click .
6. Close the **SAP Global Filter Edit** window. The **SAP Global Filter Table** opens.
7. Click . When the Status field displays “Finished!”, the fields are confirmed as modified.

To delete a SAP Circuit filter:

1. Display the **SAP Circuit Filter Table**.
2. Select an entry in the table.
3. Click . The filter is deleted.
4. Click . When the Status field displays “Finished!”, the fields are confirmed as modified.

IPX Routing Table

The **IPX Routing Table** contains the best route for each destination network that can be reached by the selected IPX router.

To display the IPX Routing Table:

- ◆ Select **Router > IPX > Routing Table**. The **IPX Routing Table** opens:

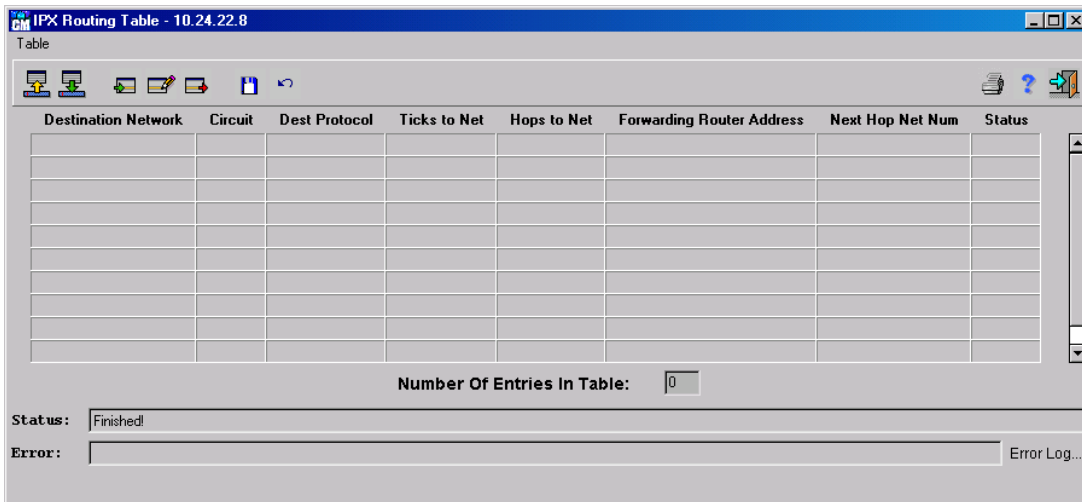



Figure 6- 166. IPX Routing Table window

The **IPX Routing Table** displays the following parameters:

- ◆ **Destination Network** – Destination IPX network numbers in ascending order.
- ◆ **Circuit** – The circuit number used to reach the next-hop.
- ◆ **Dest Protocol** – The routing protocol from which knowledge of this destination was obtained:
 - ◇ Static – User-defined entry (SNMP).
 - ◇ Local – The entry derived from an IPX interface definition.
 - ◇ RIP – The entry learned from the RIP protocol.
- ◆ **Ticks to Net** – Time estimate required for the propagation of a packet sent along the route described by this table entry to the destination network. This estimate is given in ticks (there are 18.21 ticks in a second), and does not include delays introduced by buffers used for temporary storage of packets in routers.
- ◆ **Hops to Net** – Describes this table entry number of hops on the route to the destination network. Entries with more than 15 hops are removed from the table.
- ◆ **Forwarding Router Address** – IPX node address (12 hexadecimal digits) of the next IPX router in the route to the destination network, described by this table entry. If the destination network is one of the network segments directly connected to this IPX router, this field is all zeroes.
- ◆ **Next-hop NetNum** – Next-hop IPX network number.
- ◆ **Status** – Defines whether the RIP interface is active. OFF is inactive but not deleted.

To add an IPX Routing Table entry:

1. Display the **IPX Routing Table**.
2. Click . The **IPX Routing Table Insert** window opens:

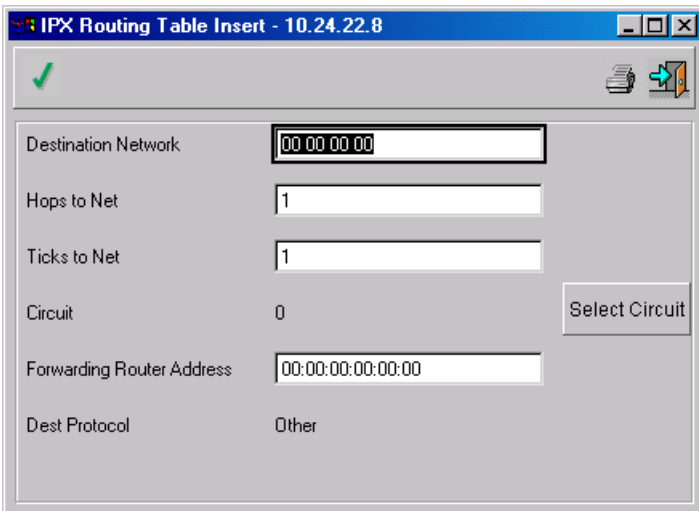

Figure 6- 167. IPX Routing Table Insert window

An IPX circuit is linked to the Destination network.

To select an IPX circuit, on the **IPX Routing Table Insert** window click the **Select Circuit** button. The **Select Circuit** window opens:

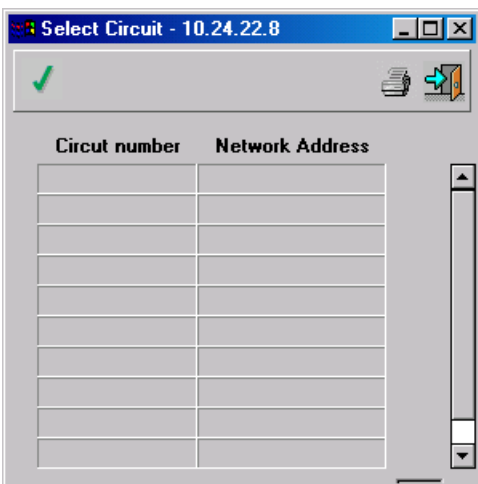





Figure 6- 168. Select Circuit window

The **Select Circuit** window displays the following parameters:

- ◆ **Circuit Number** – The IPX circuit number.
- ◆ **Network Address** – The IPX circuit network address.

3. Select an entry in the table.
4. Click .
5. Close the **Select Circuit** window. **IPX Routing Table Insert** window opens.
6. Complete the fields.
7. Click .
8. Close the **IPX Routing Table Insert** window. The **IPX Routing Table** opens.
9. Click . When the Status field displays “Finished!”, the fields are confirmed as modified.

To edit an IPX Routing Table entry:

1. Display the **IPX Routing Table**.
2. Select an entry in the table.
3. Click . The **IPX Routing Table Edit window** opens:

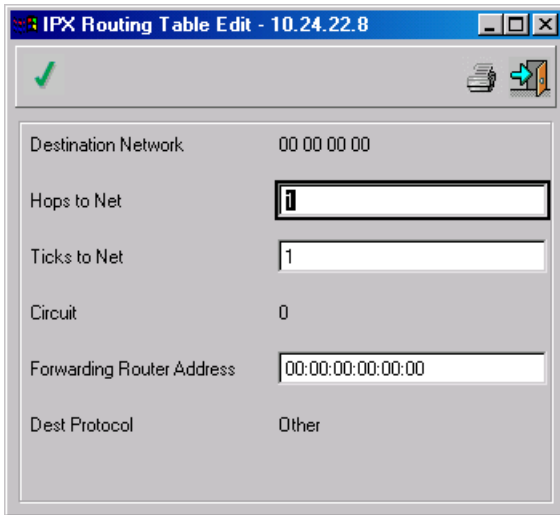





Figure 6- 169. IPX Routing Table Edit window

4. Complete the fields.
5. Click .
6. Close the **IPX Routing Table Edit** window. The **IPX Routing Table** opens.
7. Click . When the Status field displays “Finished!”, the fields are confirmed as modified.

To delete an IPX Routing Table entry:

1. Display the **IPX Routing Table**.
2. Select an entry in the table.
3. Click . The entry is deleted.
4. Click . When the Status field displays “Finished!”, the fields are confirmed as modified.

IPX SAP Table

The SAP table contains information on each server located on a destination network that can be reached by the selected IPX router.

To display the SAP Table:

- ◆ Select **Router > IPX > SAP Table**. The **IPX SAP Table** opens:

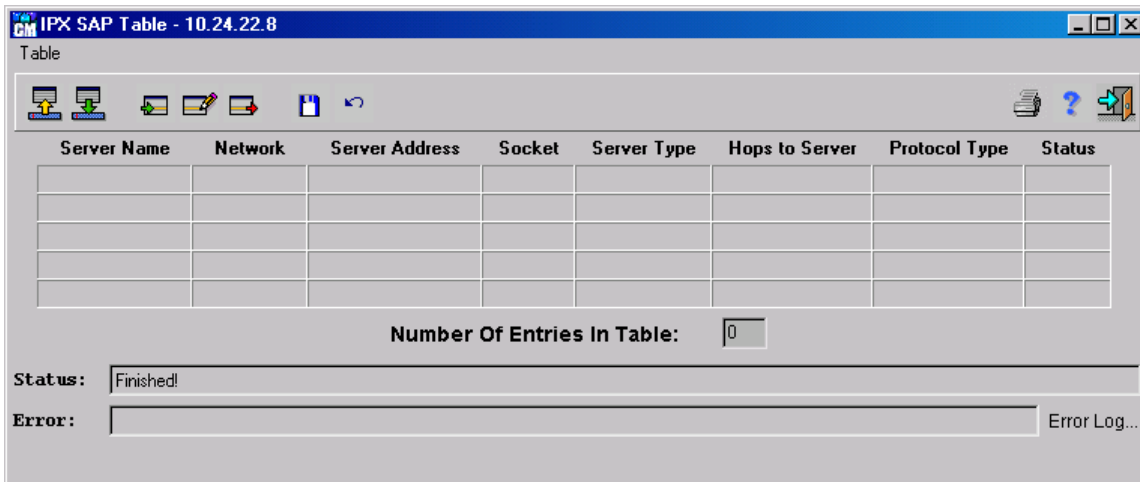



Figure 6- 170. IPX SAP Table window

The **IPX SAP Table** displays the following parameters:

- ◆ **Server Name** – Server type and server name to identify a server. The name can include up to 47 characters.
- ◆ **Network** – Network portion (eight hexadecimal digits) from the IPX server address.
- ◆ **Server Address** – Node portion 12 hexadecimal digits) from the IPX server address.
- ◆ **Socket** – Socket portion up to four hexadecimal digits) from the IPX server address.
- ◆ **Server Type** – Type of service (assigned by Novell) provided by the server.
- ◆ **Hops to Server** – Number of hops on the route to the server, as determined by the IPX SAP routing algorithm.
- ◆ **Protocol Type** – The information source protocol.
 - ◇ Static – User-defined entry (SNMP)
 - ◇ SAP – SAP protocol.
- ◆ **Status** – Defines whether the SAP interface is active. OFF is inactive but not deleted.

To add an IPX SAP Table entry:

1. Display the **IPX SAP Table**.
2. Click . The **IPX Routing Table Insert** window opens:

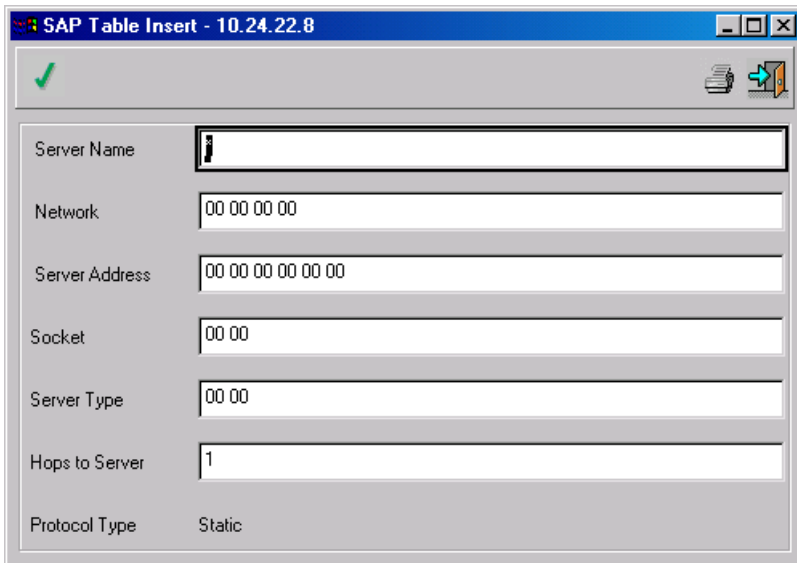





Figure 6- 171. SAP Table Insert window

3. Complete the fields.
4. Click .
5. Close the **IPX SAP Table Insert** window. The **IPX SAP Table** opens.
6. Click . When the Status field displays “Finished!”, the fields are confirmed as modified.

To edit an IPX SAP Table entry:

1. Display the **IPX SAP Table**.
2. Select an entry in the table.
3. Click . The **IPX SAP Table Edit** window opens:

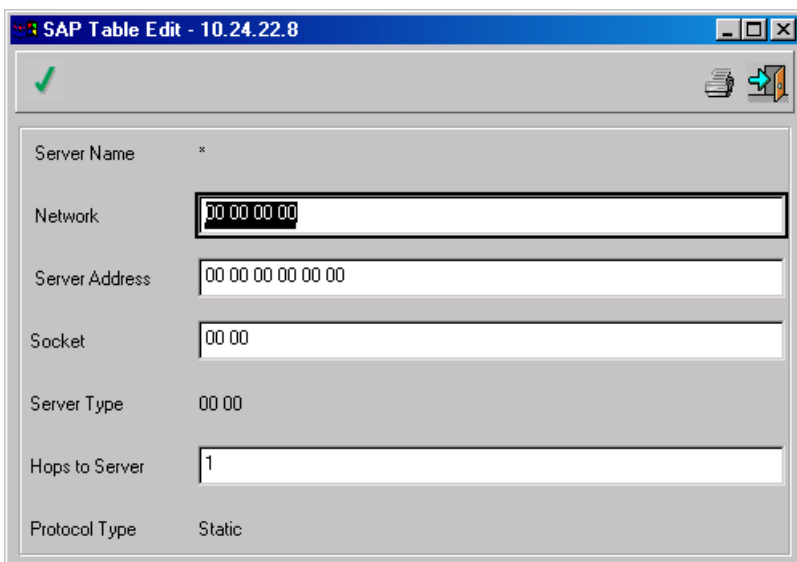





Figure 6- 172. IPX SAP Table Edit window

4. Complete the fields.
5. Click .

6. Close the **IPX SAP Table Edit** window. The **IPX SAP Table** opens.
7. Click . When the Status field displays "Finished!", the fields are confirmed as modified.

To delete an IPX SAP Table entry:

1. Display the **IPX SAP Table**.
2. Select an entry in the table.
3. Click . The entry is deleted.
4. Click . When the Status field displays "Finished!", the fields are confirmed as modified.

Configuring Security Options

This chapter describes the **Security** menu and its options, including access setting for device management.

Community Table

To enter the **Community Table**, *Super* access is required.

To display the Community Table:

- ◆ Select **Security > Community Table**. The **Community Table** opens:

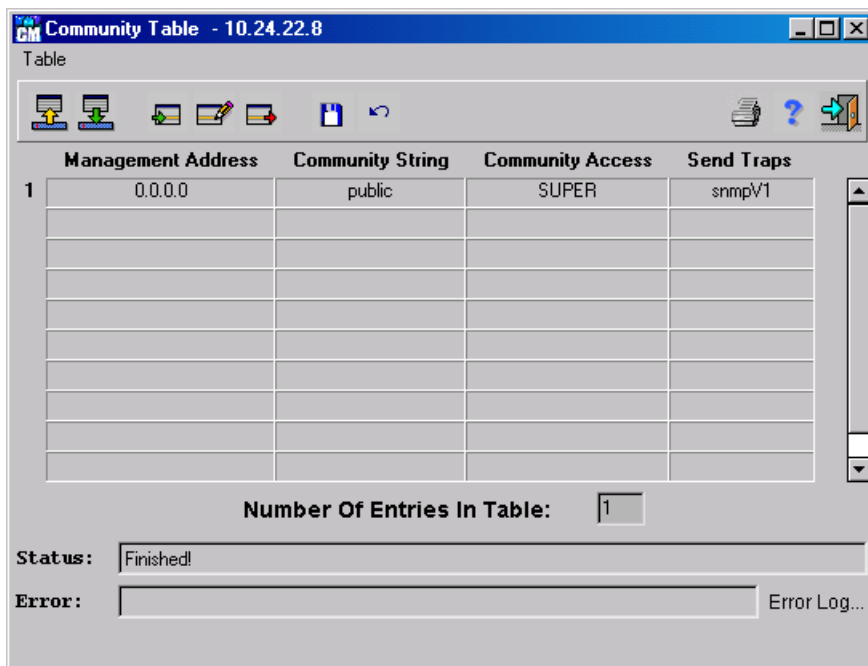

Figure 6- 173. Community Table window

The **Community Table** displays the following parameters:

- ◆ **Management Address** – Management station IP address.
- ◆ **Community String** – Management station community name. This parameter operates as a password for gaining various access rights: for each device various communities with different names and access rights can be created.

◆ **Community Access** – Defines whether the management station access is *Read Only* or *Read Write*. Choose *Super Community* to set the name used to access the *Community Table*. The possible values are:

- ◇ Read Only
- ◇ Read Write
- ◇ Super

◆ **Send Traps** – Whether the management station receives traps from the device (*Enable*) or not (*Disable*).

Note: To change the community, *Super Community* access is required.

To add a Community Table entry:

1. Display the **Community Table**.
2. Click . The **Community Table Insert** window opens:

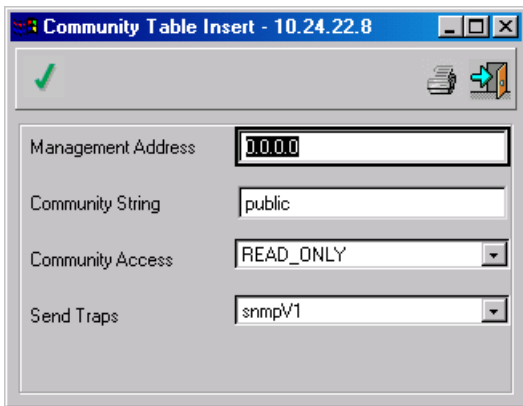





Figure 6- 174. Community Table Insert window

3. Complete the fields.
4. Click .
5. Close the **Community Table Insert** window. The **Community Table** opens.
6. Click . When the Status field displays “Finished!”, the fields are confirmed as modified.

To edit a Community Table entry:

1. Display the **Community Table**.
2. Select an entry in the table.
3. Click . The **Community Table Edit** window opens:

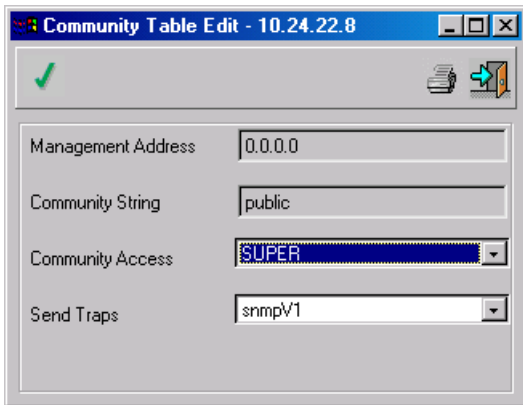



Figure 6- 175. Community Table Edit window

4. Complete the fields.
5. Click .
6. Close the **Community Table Edit** window. The **Community Table** opens.
7. Click . When the Status field displays “Finished!”, the fields are confirmed as modified.

To delete a Community Table entry:

1. Display the **Community Table**.
2. Select an entry in the table.
3. Click . The entry is deleted.
4. Click . When the Status field displays “Finished!”, the fields are confirmed as modified.

Configuring Quality of Service

This section describes the **QoS** menu and its options, including policies and creating, editing, and deleting rules, IP classification fields, and policy profiles.

Quality of Service (QoS) allows network managers to improve the flow of network traffic based on policies. Policies are comprised of profiles, classification fields, and rules.

The **QoS** menu has the following menu options:

- ◆ Global Parameters
- ◆ Profile Table
- ◆ Routed IP

Global Parameters

Note: *To enable QoS, ensure that the auto-negotiation is disabled and that the output port is in full duplex mode.*

The **QoS Global Parameters** window allows you to enable or disable a policy on a device. Policies are sets of profiles and rules that allow you to manage network traffic.

To display the QoS Global Parameters window:

- ◆ Select **QoS > Global Parameters**. The **QoS Global Parameters** window opens:

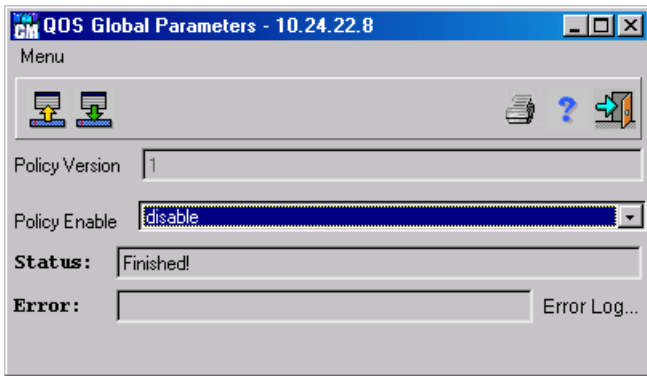



Figure 6- 176. QOS Global Parameters window

The **QOS Global Parameters** window displays the following parameters:

- ◆ **Policy Enabled** – If enabled, this policy is enabled on the device.

To enable a policy on a device:

1. Display the **QOS Global Parameters** window.
2. Set the policy status to enabled.
3. Click  to update the device. When the Status field displays “Finished!”, the policy is enabled on the device.

Profile Table

Profiles determine the actions taken on a packet entering a device according to their bandwidth definitions.

To display the Profile Table:

- ◆ Select **QoS > Profile Table**. The **QOS Profile Table** opens:

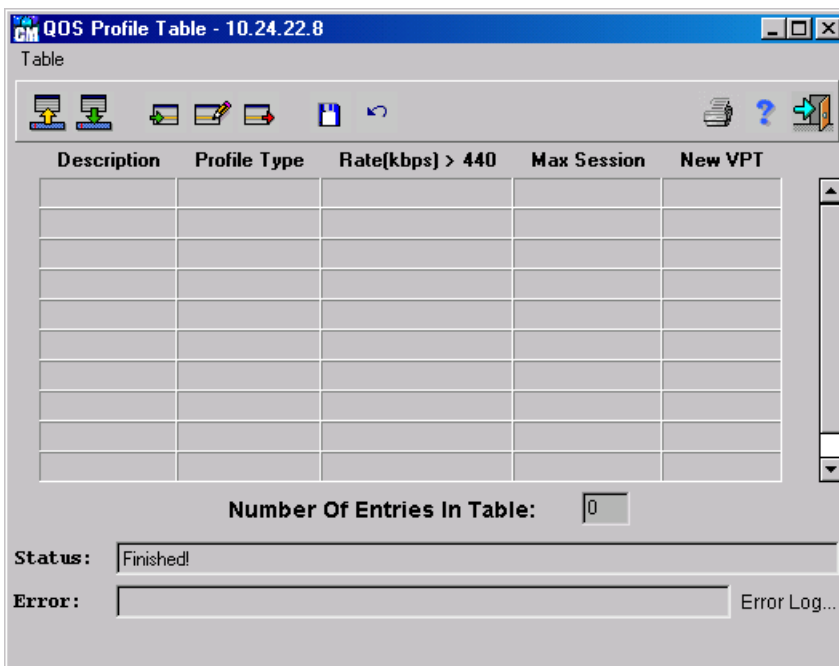

Figure 6- 177. QOS Profile Table window

The **QOS Profile Table** displays the following parameters:

- ◆ **Description** – The user-defined description of the profile.
- ◆ **Profile Type** – The type of forwarding service to be applied to packets. The possible values are:
 - ◇ **BandwidthGuarantee** – Defines the bandwidth size for packets being forwarded. Packets must meet the bandwidth requirements to be forwarded. Packets exceeding the defined bandwidth size are dropped.
 - ◇ **minbandwidthGuarantee** – Defines the minimum bandwidth size for packets being forwarded. Packets beyond the defined bandwidth size receive a best-effort forwarding priority.
 - ◇ **minDelay** – Forwards packets with a priority of real time forwarding. Packets exceeding the assigned amount of bandwidth are dropped.
 - ◇ **minDelayPerSession** – Defines the amount of bandwidth per session for a real time forwarding priority. Sessions exceeding the defined amount of sessions are dropped.
- ◆ **Rate (kbps) > 440** – The rate in kilobits/seconds assigned to a profile for forwarding a packet. The values are 0-12 Gbps depending on the output port.
- ◆ **Max Session** – Max Session is only relevant to the *minDelayPerSession* profile type. Indicates the maximum number of sessions that can occur for a profile instance.
- ◆ **New VPT** – The VPT (VLAN Priority Tag). The possible values are 0-7. Zero is the default. The higher the Vpt tag value the higher the forwarding priority.
- ◆ **New ToS** – Type of Service. Enables you to override the ToS value. The possible values are 0-3.
- ◆ **Burst Size (bytes)** – The amount of bytes that can be forwarded back-to-back faster than normal speed. If the value is 0, the device uses a predefined value. The default size is 0. If the burst size value is 0, the value for *minDelayPerSession* and *minDelay* is 1,536 bytes. *MinbandwidthGuarantee* and *BandwidthGuarantee* are forwarded with a value of 3x 1,536 bytes.

To add a new profile:

1. Display the **QOS Profile Table**.
2. Double-click an empty row in the **QOS Profile Table**.

or

Click . The **Insert Profile** window opens. The **Insert Profile** window has two tabs:

- ◆ **Main tab** – Displays the main options for assigning profiles including the profiles description, type, rate, maximum sessions, and new Vpt. The default tab is the **Main** tab.
- ◆ **Advanced tab** – Displays advanced options for assigning profiles including new ToS and burst size.

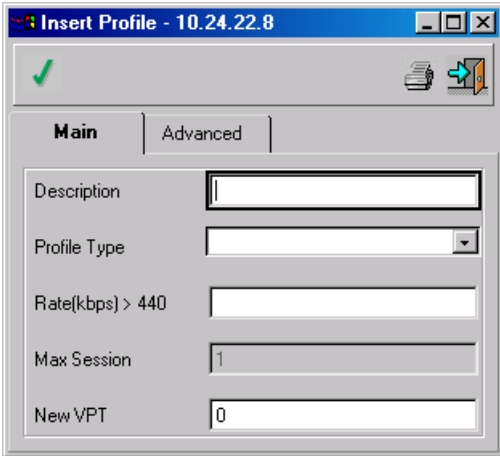



Figure 6- 178. Insert Profile window - Main tab

3. Complete the fields. The fields are the same as the **Profile Table** as described above.
4. Click . The **Insert Profile** window closes.
5. Click  to update the device. When the Status field displays “Finished!” the profile is saved to the device.

or

Select the **Advanced** tab. The **Advanced** tab opens:

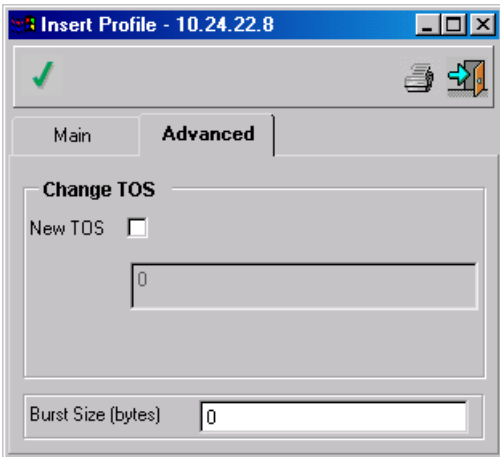





Figure 6- 179. Insert Profile window - Advanced tab

1. Complete the fields. The fields are the same as the **Profile Table** as described above.
2. Click . The **Insert Profile** window closes.
3. Click . When the Status field displays “Finished!”, the profile is saved to the device.

To edit a profile:

1. Display the **Profile Table**.
2. Select an entry in the **Profile Table** and click . The **Edit Profile** window opens.

or

Double-click a row in the **Profile Table**. The **Edit Profile** window opens:

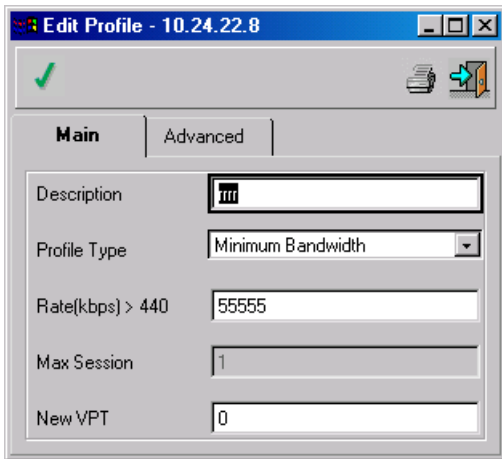

Figure 6- 180. Edit Profile window - Main tab

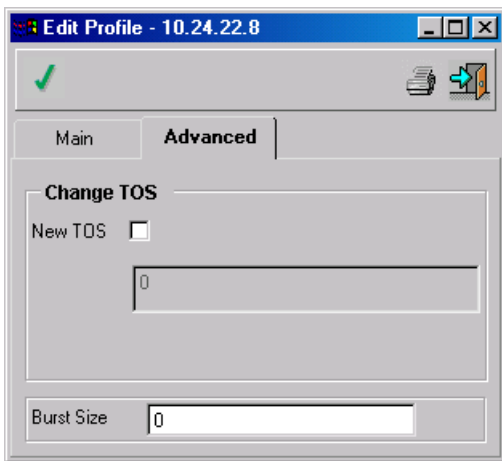





Figure 6- 181. Edit Profile window - Advanced tab

3. Edit the fields. The fields are the same as the **Profile Table** as described above.
4. Click . The **Edit Profile** window closes.
5. Click . When the Status field displays “Finished!”, the profile is saved to the device.

To delete a profile:

1. Display the **Profile Table**.
2. Select an entry in the table.
3. Click . The entry is deleted from the **Profile Table**.
4. Click  to update the device. When the Status field displays “Finished!”, the profile is deleted from the device.

Note: Profiles attached to a rule cannot be deleted.

Routed IP

The **Routed IP** menu has the following menu options:

- ◆ Routed IP Classification Fields
- ◆ Routed IP Rules Table

IP Classification Fields

IP Classification Fields window allows you to define the fields used to classify network traffic.

To display the IP Classification Fields window:

- ◆ Select **QoS > Routed IP > Routed IP Classification Fields**. The **IP Classification Fields** window opens:

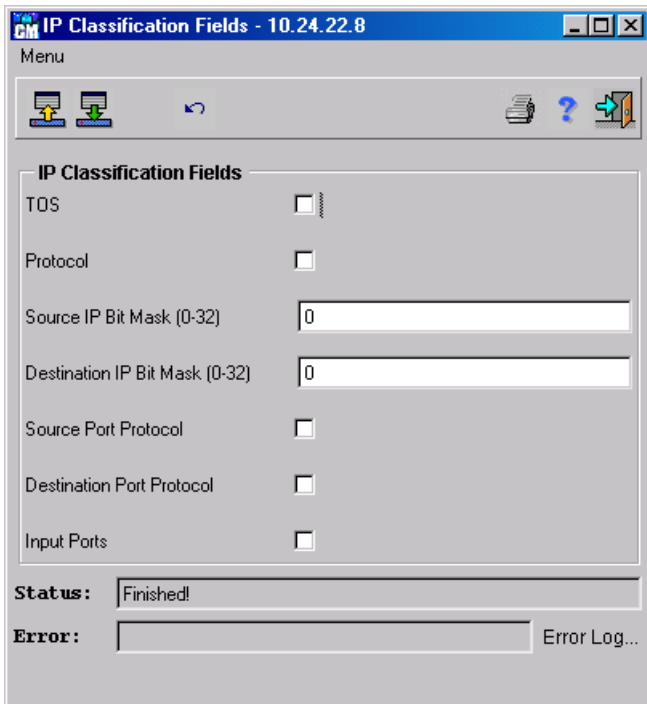



Figure 6- 182. IP Classification Fields window

The **IP Classification Fields** window displays the following parameters:

- ◆ **ToS** – Type of Service. Enables (checked) classification by the ToS tagging for forwarding packets.
- ◆ **Protocol** – Enables (checked) classification of packets by their type of protocol.
- ◆ **Source IP Bit Mask (0-32)** – Used to mask all or part of the source IP address. If selected, QoS matches packets arriving from the indicated source IP address, within the limits of the source IP mask. The values are 0-32.
- ◆ **Destination IP Bit Mask (0-32)** – Used to mask all or part of the destination IP address. If selected, QoS matches packets being sent to the indicated destination IP address, within the limits of the destination IP mask. The values are 0-32.
- ◆ **Source Port Protocol** – Enables (checked) the classification of arriving packets by their source port protocol type.
- ◆ **Destination Port Protocol** – Enables (checked) the classification of arriving packets by their destination port protocol type
- ◆ **Input Ports** – Enables (checked) the classification of arriving packets by the physical input port.

To Define the IP Classification Fields

1. Display the **IP Classification Fields** window.
2. Complete the fields. The fields are the same as the IP Classification Fields described above.

- Click  to update the device. When the Status field displays “Finished!”, the IP Classification Fields are saved to the device.

IP Rules Table

The **IP Rules Table** allows you to define the filters that determine which network traffic is managed. The **IP Rules Table** contains two types of filters:

- ◆ Filters that determine how packets are matched to a rule. For example, the Protocol, ToS, Source Port, Destination Port, Input Ports, and Output Ports fields.
- ◆ Filters that determine what forwarding action is taken on packets. For example, the Condition and Actions fields.

Note: The fields that appear in the **IP Rules Table** reflect the IP Classification Fields that were selected.

Note: Rules cannot be added to the IP Rules Table if the IP Classification Fields have not been defined.

To display the IP Rules Table:

- ◆ Select **QoS > IP > IP Rules Table**. The **IP Rules Table** opens:

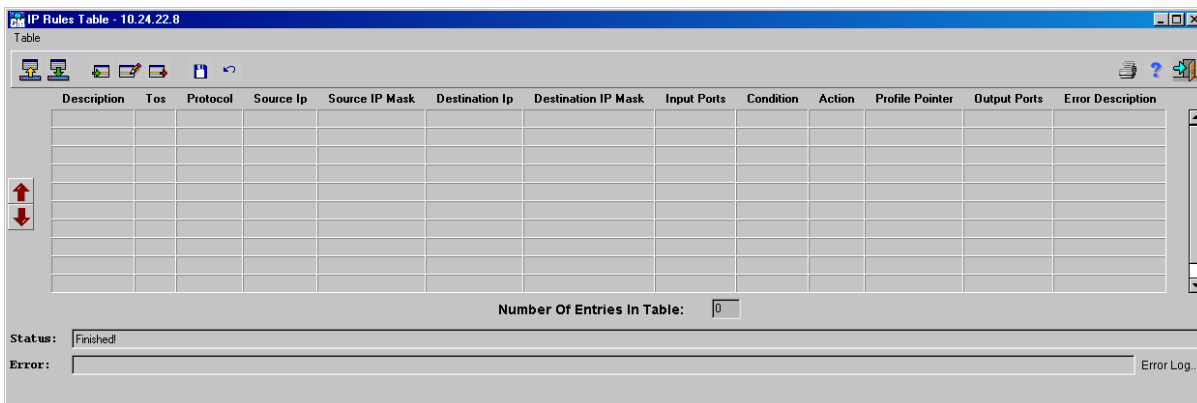

Figure 6- 183. IP Rules Table window

The **IP Rules Table** contains fields that reflect the type of IP Classification Fields selected and additional parameters for forwarding packets:

- ◆ **Description** – The user-defined description of the rule.
- ◆ **ToS** – Type of Service. Indicates the predefined ToS used to classify packets. If selected, the rule applies to packets matching the ToS type. The possible values are 0-3. The default value is disabled.
- ◆ **Protocol** – The protocol type. Indicates the type of predefined protocols used to classify packets. If selected, the rule applies to packets of this indicated protocol. The possible values are TCP or UDP.
- ◆ **Source IP** – The source IP address of packets being matched to the rule. If selected, QoS matches the rule to packets arriving from the indicated source IP address.
- ◆ **Source IP Mask** – Used to mask all or part of the source IP address. If selected, QoS looks for and matches the rule to packets being sent from the indicated source IP address, within the limits of the Source IP Mask. The Source IP Mask must not exceed the limits set in the *IP Classification* fields.
- ◆ **Destination IP** – The destination address of packets being matched to the rule. If selected, QoS looks for and applies the rule to packets being sent to the indicated IP address.

◆ **Destination IP Mask** – Used to mask all or part of the destination IP address. If selected, QoS looks for and matches the rule to packets being sent to the indicated destination IP address, within the limits of the destination IP mask. The Destination IP Mask must not exceed the limits set in the IP Classification fields.

◆ **Source Port** – Indicates if and which source port should be used when matching the rule to packets.

◆ **Destination Port** – Indicates if and which destination port should be used when matching the rule to packets.

◆ **Condition** – Specifies whether the packets' value should be different from the rules' value. The possible values are:

- ◇ Bigger – Looks for a higher value than the exact data. Indicates that the parameter values of a packet should be larger than the parameter values of the rule.
- ◇ Smaller – Looks for a lower value than the exact data. Indicates that the parameter values of a packet should be smaller than the parameter values of the rule.
- ◇ Equal – Looks for the exact data. Indicates that all of the parameter values of a packet should match all of the parameter values of the rule.
- ◇ Not Equal – Looks for non-matching data. Indicates that none of the parameter values of a packet should match the parameter values of the rule. All values must be different.

◆ **Input Port** – Indicates to which ports this rule applies. Packets arriving from the defined port are forwarded according to the rule definition.

◆ **Action** – The action to be taken on packets when matched to the rule. The possible values are:

- ◇ Block – Drops packets.
- ◇ Block and Trap – Drops packets and notifies the CPU that packets were dropped.
- ◇ Permit – Forwards packets. If the action is *permit*, then the output ports to which this rule applies can be selected. This is the default value.

◆ **Profile Pointer** – Indicates which profile is attached to the rule. This field is only active if the forwarding action of the packet is *permit*. The default value is 0. Zero is illegal if the action is *permit*.

◆ **Output Ports** – Indicates to which ports this rule applies. This field is only active if the forwarding condition of the packet is *permit*. The default value is all ports.

◆ **Error Description** – Indicates if the rule is valid. The error description can be one of the following:

- ◇ The bandwidth specified exceeds the available specified bandwidth on the output ports – Indicates that the amount of the bandwidth specified exceeds the available amount of bandwidth as defined for the profile matching the rule.
- ◇ The QoS lock failed – Indicates that the rule cannot be applied to a packet. The possible reasons are:
 - ◆ Auto-negotiation is enabled.
 - ◆ The port is not in full duplex mode.

◆ **Status** – Indicates rule's status. The rule status can be one of the following:

- ◇ Active – The rule is legal and currently active.
- ◇ Not in Service – The rule is currently not active.

- ◇ Not Ready – Indicates that some of the output ports do not meet the bandwidth allocation prerequisites or QoS locking prerequisites. Auto-negotiation should be disabled and the output port should be in full duplex mode.

Note: *The first rule matching a packet is applied, therefore, the order of the rules in the IP Rules Table is important.*

To add a new rule in IP Rules Table:

1. Display the **IP Rules Table**.
2. Double-click an empty row in the **IP Rules Table**.

or

Click . The **IP Rules Insert** window opens. The **IP Insert Rules** window has the following tabs:

- ◆ **General** – Displays the general options for assigning rule value including the user-defined description, error description and if the rule is currently active.
- ◆ **Classification** – Displays the IP Classification Fields for assigning rule value including the ToS, protocol types, source and destination IP addresses, source and destination IP address masks, source and destination ports, and conditions.
- ◆ **Input Ports** – Displays a list of input ports to choose from for assigning rule value.
- ◆ **Action** – Displays the action options for assigning rule value, including a list of the optional output ports if the action is *permit*.
- ◆ **Profiles** – Displays the profiles to attach to a rule if the action value is **permit**. The **Profiles** tab is grayed out if the action is *block* or *block and trap*. The **Profiles** tab displays the same fields as the **Profile Table**. For a list of the fields in the **Profile Table**.

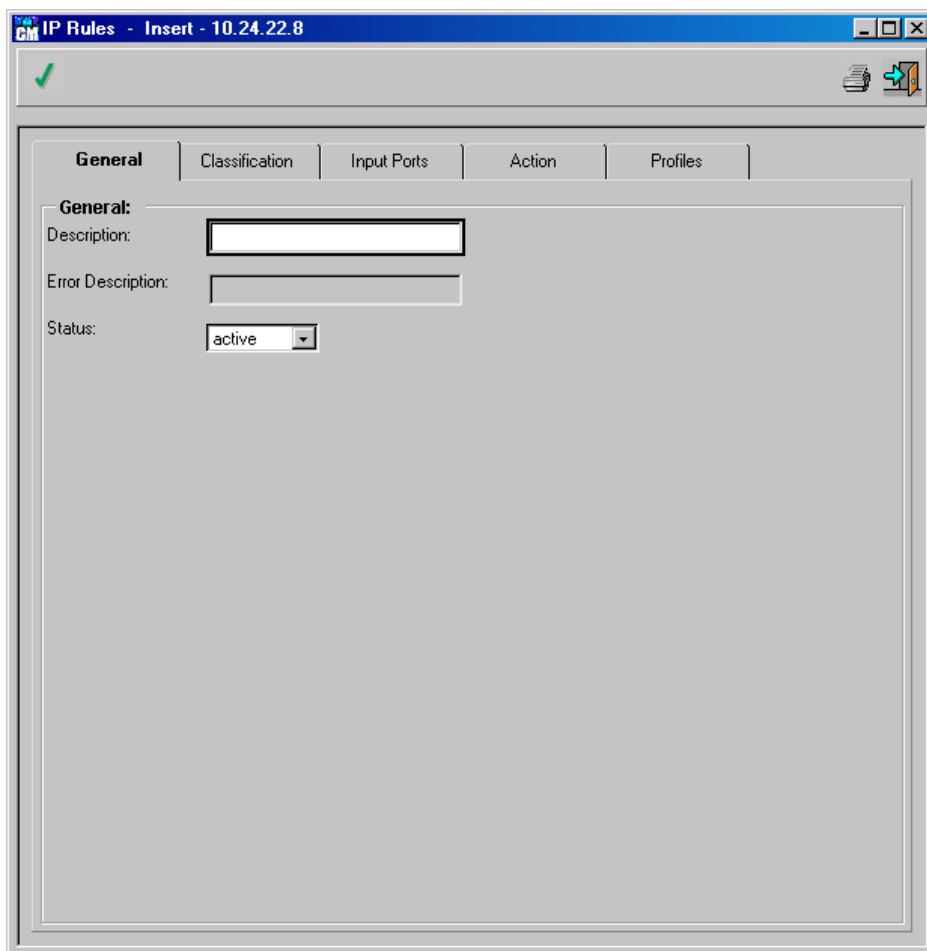

Figure 6- 184. IP Rules - Insert window General tab

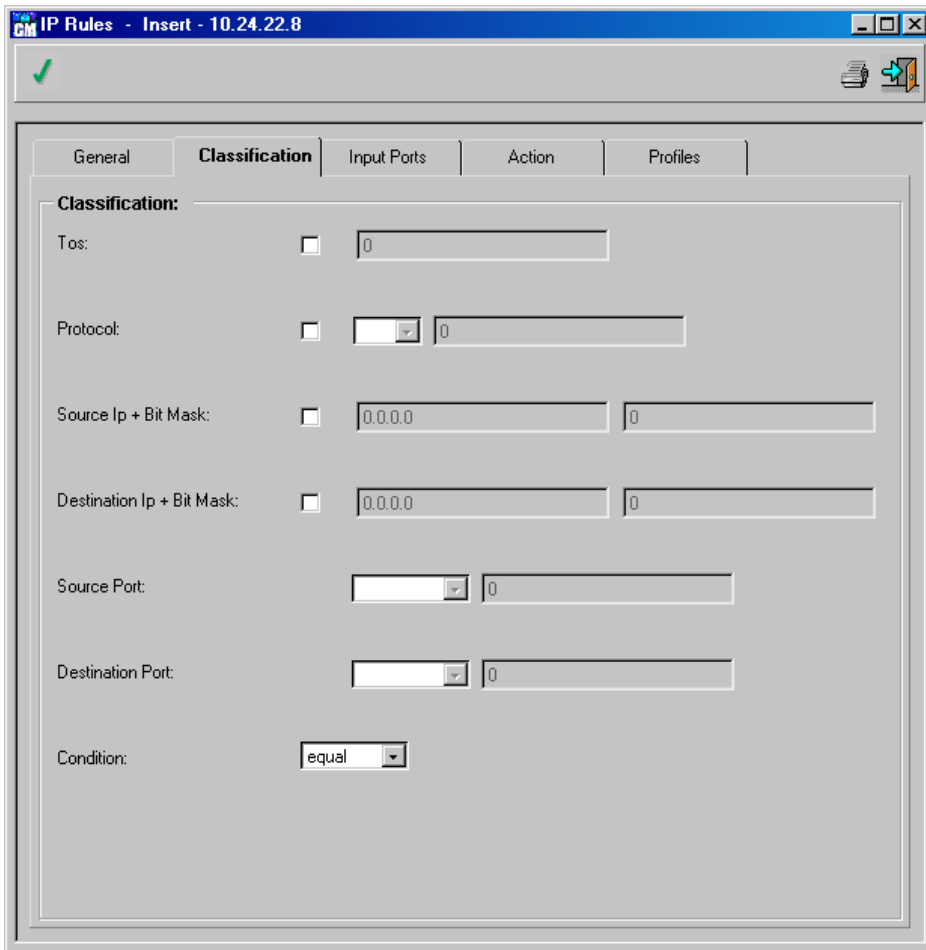

Figure 6- 185. IP Rules - Insert window Classification tab

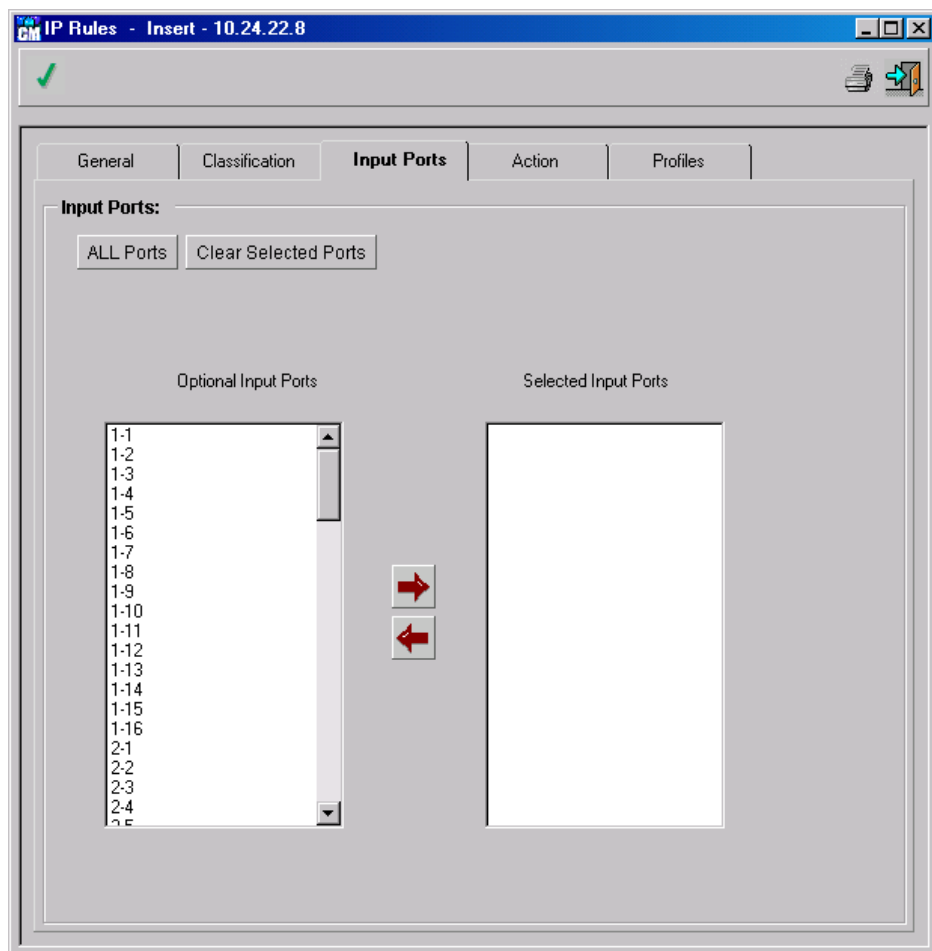

Figure 6- 186. IP Rules - Insert window Input Ports tab

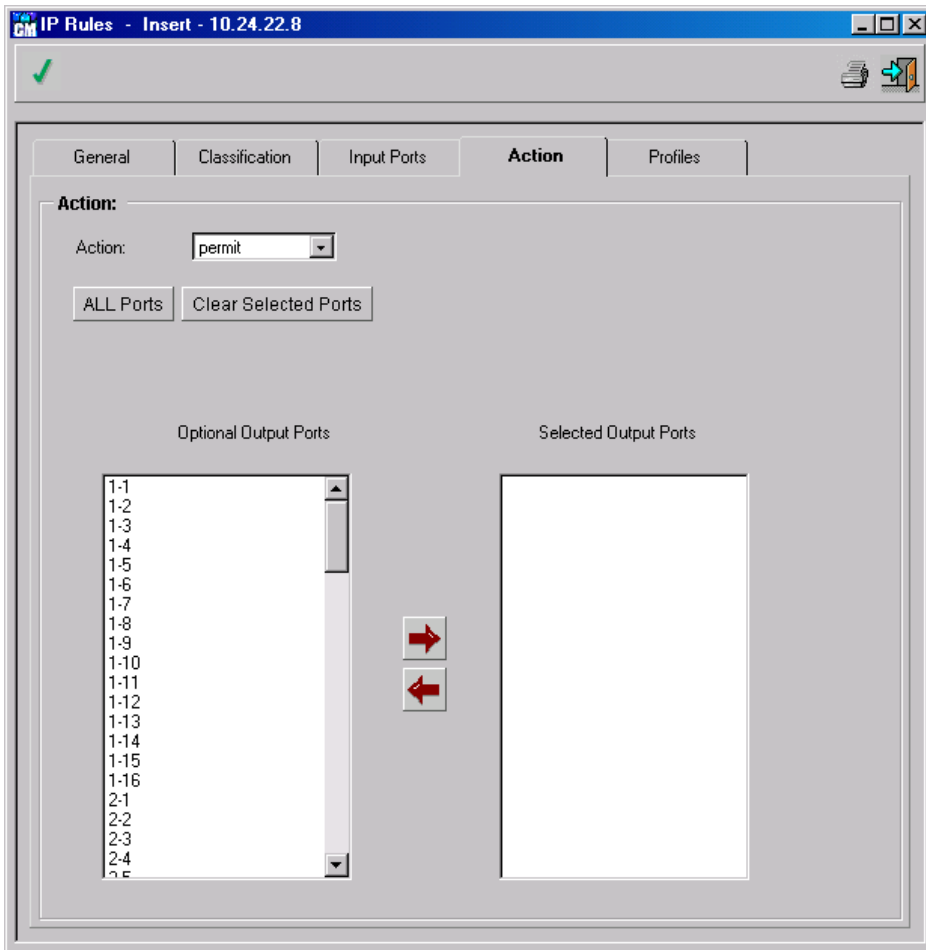

Figure 6- 187. IP Rules - Insert window Action tab

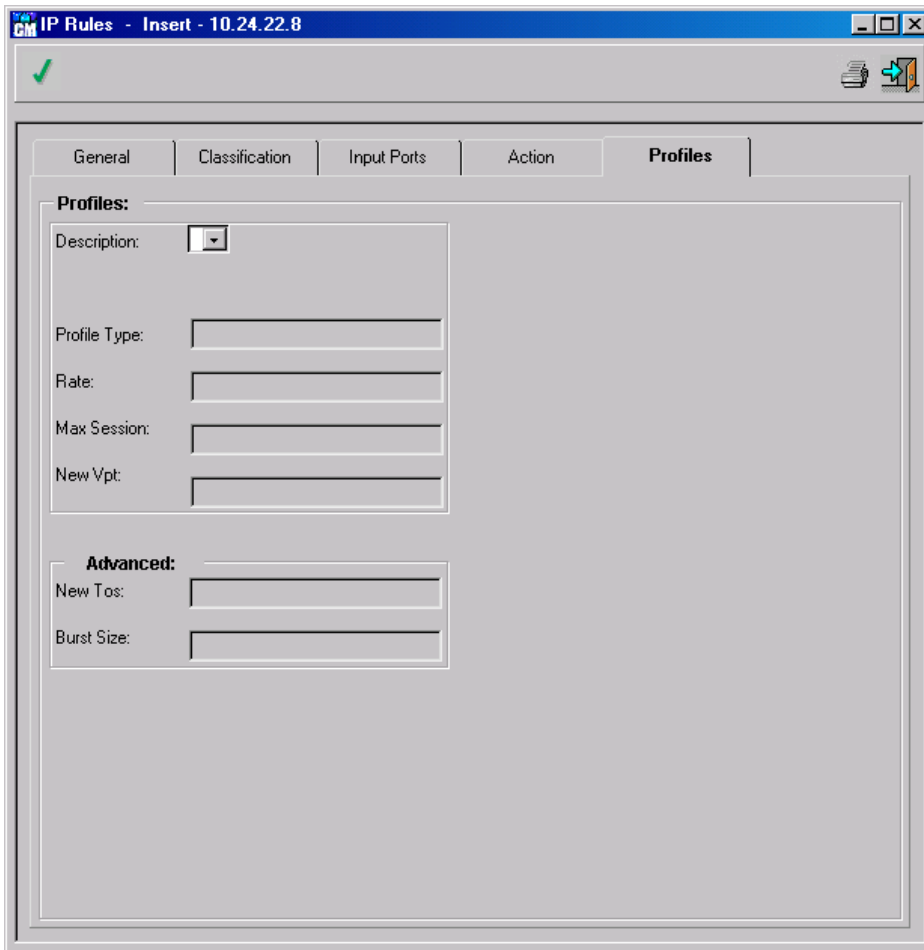





Figure 6- 188. IP Rules - Insert window Profiles tab



1. Complete the fields. The fields are the same as the **IP Rules Table** as described above, except for the **Profiles** tab.
2. Click . The **IP Rules Insert** window closes.
3. Click  to update the device. When the Status field displays "Finished!", the rule is saved to the policy. If the rules could not be set to the device, one of two errors may occur:
 - ◇ The bandwidth specified exceeds the available specified bandwidth on the output port.
 - ◇ The QoS lock failed.

To edit a rule:

1. Display the **IP Rules Table**.
2. Select an entry in the **IP Rules Table** and click . The **IP Rules Table - Insert** window opens.
or
Double-click a row in the **IP Rules Table**. The **IP Rules Table - Insert** window opens.
3. Edit the fields. The fields are the same as the **IP Rules Table** as described above, except for the **Profiles** tab.
4. Click . The **IP Rules Insert** window closes.

5. Click  to update the device. When the Status field displays “Finished!”, the rule is saved to the device.

To delete a rule:

1. Display the **IP Rules Table**.
2. Select an entry in the table.
3. Click . The entry is deleted.
4. Click  to update the device. When the Status field displays “Finished!”, the rule is deleted from the policy.

Working With Statistics

Devices supporting DECnet allow individual DECnet circuit counters to be graphed, and to reset those counters.

The BadPackets SNMP counter of certain devices is automatically monitored, and by default, provides information when an unusually high concentration of error packets occur. The relevant parameters are called the Threshold Parameters. The Threshold Parameters can be modified or disabled.

The **Statistics** menu has the following menu options:

- ◆ Element Statistics
- ◆ Interface Statistics
- ◆ Port Statistics
- ◆ History
- ◆ Alarm Table
- ◆ Statistics Table
- ◆ Traps Table
- ◆ Log Table

Element Statistics

Element Statistics describes the device as a complete unit. The display is real-time.

To display Element Statistics:

1. Select **Statistics > Element Statistics**, or click , or press **Ctrl+P**. The **Element Statistics** window opens:

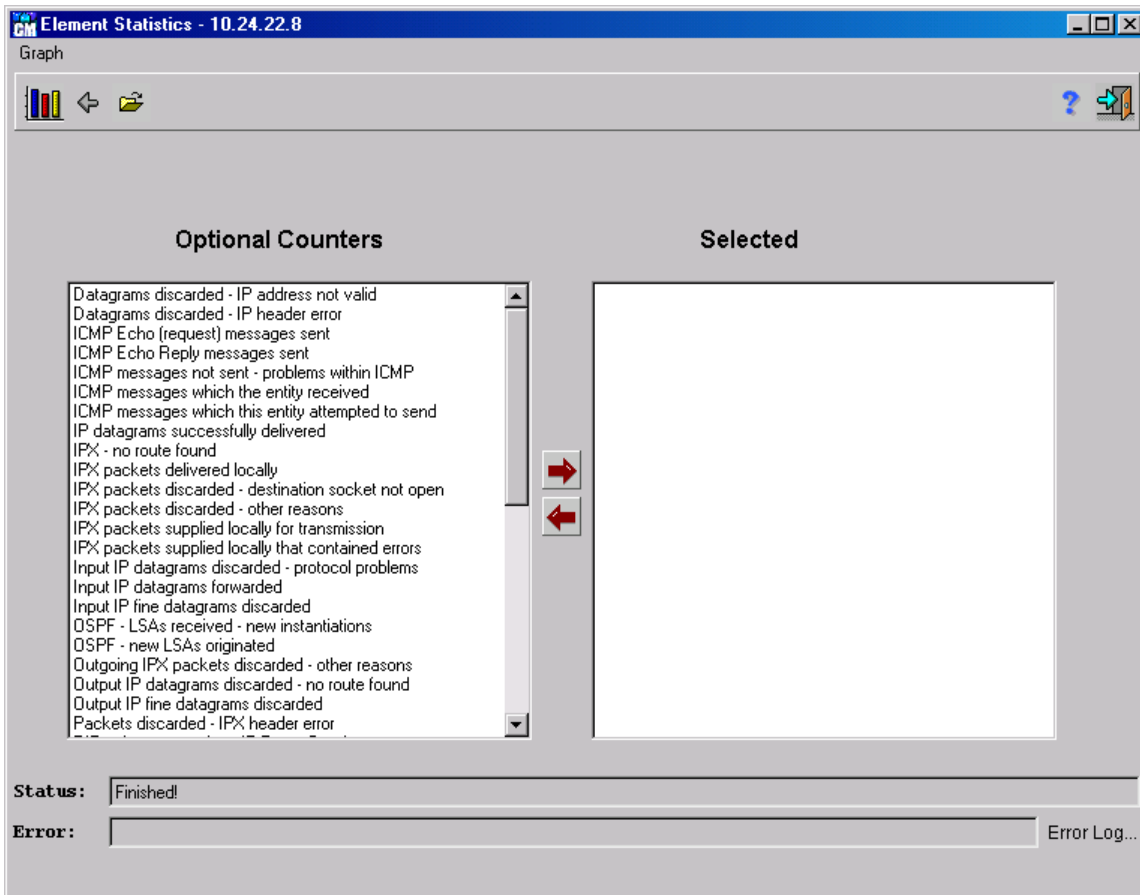



Figure 6- 189. Element Statistics window

2. Select the MIB required variables by one of the following methods:
 - ◇ Double-click on the variable in the Optional Counters box. The variable is moved to the Selected box.

or

 - ◇ Select the variable in the Optional Counters box and click . The variable is moved to the Selected box.

To remove a selected variables use one of the following methods:

1. Double-click on the variable in the selected box.
2. Select the variable Selected box and click .

To save a graph configuration use one of the following methods:

- ◇ Click . The configuration file can be edited with a standard editor

To load a previously saved graph configuration use one of the following methods:

1. Click **Graph**, then click **Load configuration from file**. An **Open File** window opens:

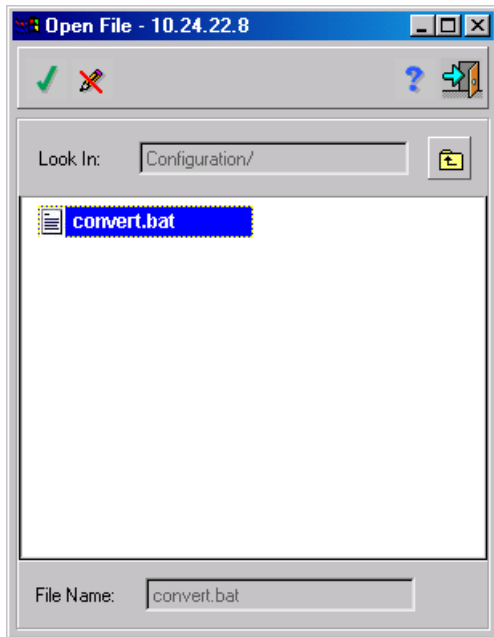



Figure 6- 190. Open File window

2. Select the file.
3. Click . The graph opens:

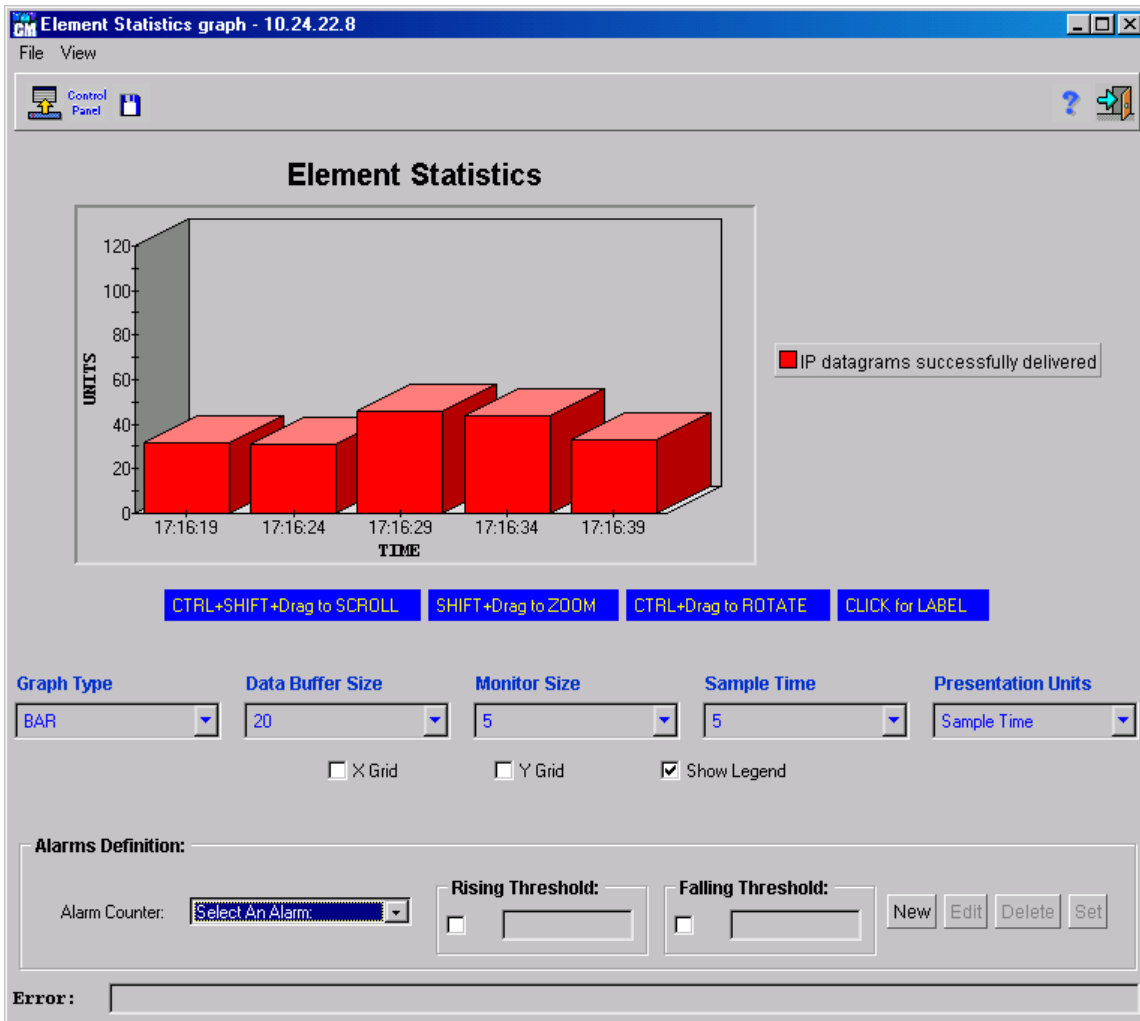

Figure 6- 191. Element Statistics Graph window

The display is comprised of the following areas:

- ◆ Menu Bar
- ◆ Tool Bar
- ◆ Graph
- ◆ Legend
- ◆ Display Configuration
- ◆ Graph Controls
- ◆ Display Controls
- ◆ Alarm Definitions
- ◆ Other Controls

Menu Bar

The Menu Bar has two commands:

- ◆ **File** – Has the following menu options:
 - ◇ Save Configuration – Saves the current statistic configuration.

- ◇ Close – Closes the graph window.
- ◆ **View** – Has the following menu options:
 - ◇ Show/Hide Control Panel – Hides the Display and Graph controls.
 - ◇ Help

Tool Bar

The Tool Bar has the following icons:



Hides the Display and Graph controls.



Saves the current statistic configuration.

Graph

The graph is real-time with constant updates according to the Sample Time. The results shift as the new data is mapped on the graph. The Sample Time is displayed in the Graph Control area.

Legend

A list displaying the MIBs in the graph and their automatically assigned color-codes. Check/clear the **Show Legend** checkbox to display or hide the graph legend.

Display Configuration

The graph in the display area can be manipulated into different configurations.

Graph Controls

This area describes the parameters used in generating the data for display in the graphs. They include the following:

- ◆ **Graph Type** – Choose from various graphs types for data analysis. The available graph types are; bar, area, stacking area, plot, scatter-plot, stacking-bar and pie.
- ◆ **Data Buffer Size** – How many polling sessions will remain in memory for viewed by scrolling. Range is 5 to 100.
- ◆ **Monitor Size** – How many polling sessions are displayed without scrolling. Range is 1 to 100.
- ◆ **Sample Time** – How often the device or interface is polled (time interval, in seconds, between polling sessions). Range is 3 to 3600 seconds.
- ◆ **Presentation Units** – How often the histogram is updated.

If the Presentation Units value is set to Sample Time, the graph is updated at the polling rate specified in the Sample Time field.

If the Presentation Units is set to a value different from the Sample Time value, the histogram is updated at the Presentation Units rate displaying the estimated polling results. The graph is also updated with the true data at the Sample Time rate.

Set the Presentation Units to a value lower than the Sample Time in traffic-heavy systems (where too frequent system polling is not recommended).

For example: if the Sample Time is set to 10 seconds and the Presentation Units to 1 second, the graph is refreshed every second with extrapolated data and every 10 seconds with true data.

Display Controls

This area controls what is displayed on the screen.

Alarm Definitions

Displays the variable alarm characteristics.

Other Controls

Other controls include the following:

To display graph data from earlier time periods available in the buffer:

Press **Ctrl** and **Shift** while dragging the mouse on the graph to the right. The graph temporarily stops moving and is dragged back to an earlier period within the same session.

To return to current data

Press **Ctrl** and **Shift** while dragging the mouse to the left.

To Zoom into a particular graph area:

Press **Shift** while dragging the mouse. When the mouse button is released, the selected area is expanded. Click the **Reset Display** button to return to normal viewing.

To rotate the graph

Press **Ctrl** while dragging the mouse.

To display actual variable values:

Click on a graph element. A label with the following information opens:

- ◇ Variable name.
- ◇ Variable current value.

To Hide the Control Panel:

Click the **Control Panel** button to hide the control panel or display it beneath the graph .

Interface Statistics

There are two types of interface statistics:

- ◆ IP Statistics
- ◆ IPX Statistics

IP Statistics

To display IP Interface Statistics:

1. Select **Statistics > Interface Statistics > IP Statistics**. The **IP Statistics Interface Selection Table** opens:

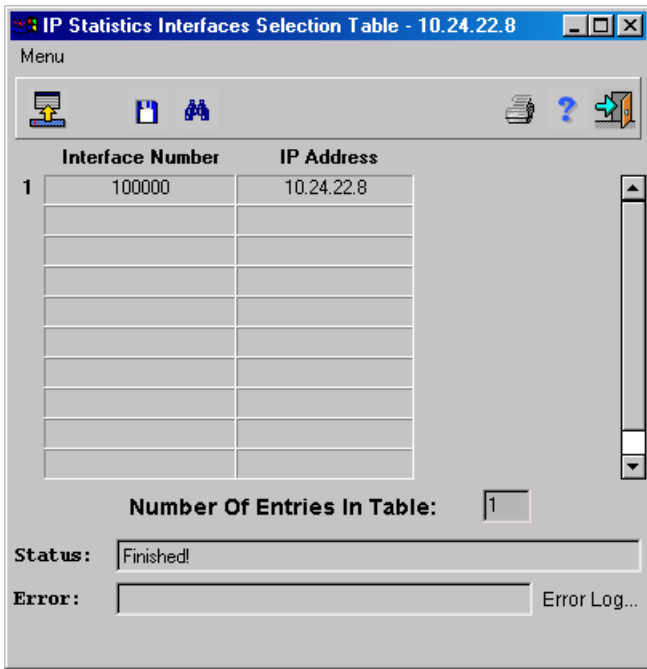

Figure 6- 192. IP Statistics Interface Selection Table window

2. Select an entry and click. The **IP Statistics** window opens:

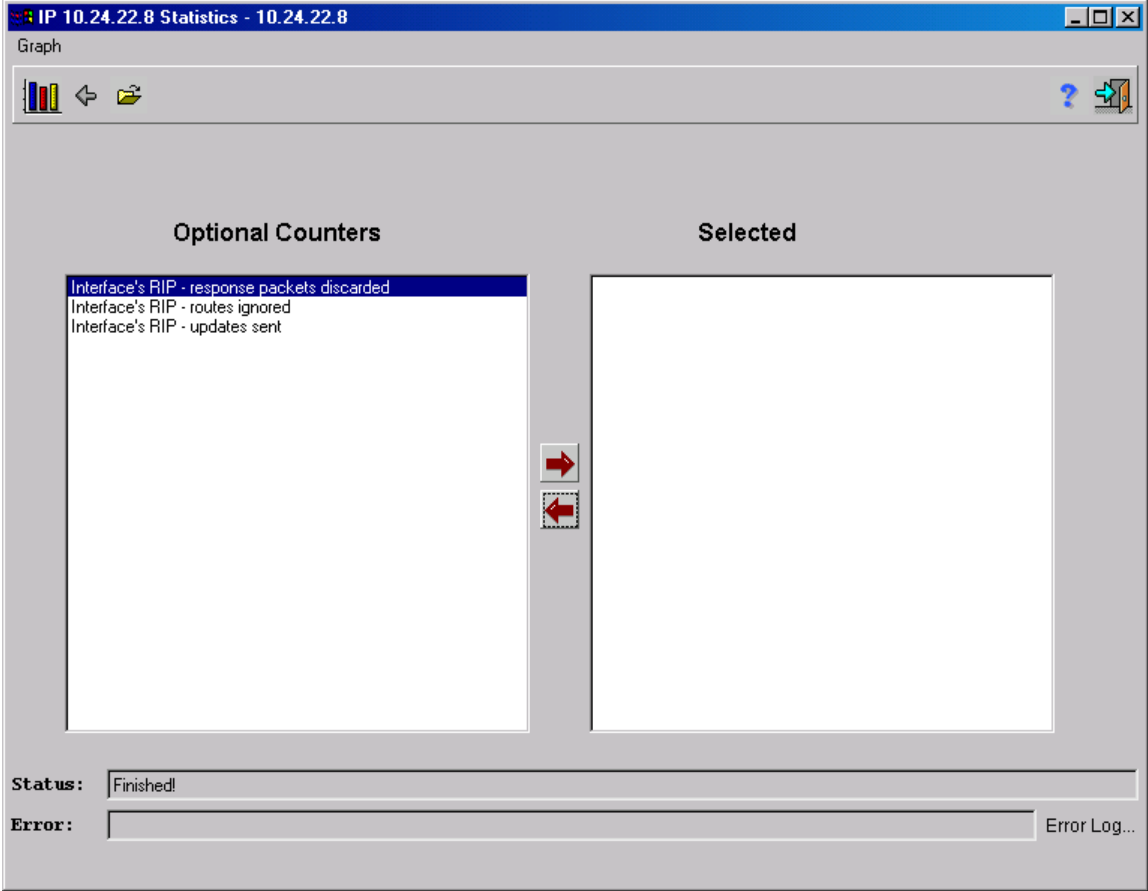



Figure 6- 193. IP Statistics window

3. Select the MIB required variables by one of the following methods:
 - ◇ Double-click on the variable in the Optional Counters box. The variable is moved to the Selected box.

or

 - ◇ Select the variable in the Optional Counters box and click . The variable is moved to the Selected box.
4. Click . The graph opens.

IPX Statistics

To display IPX Interface Statistics:

1. Select **Statistics > Interface Statistics > IPX Statistics**. The **IPX Statistics Interface Selection Table** opens:

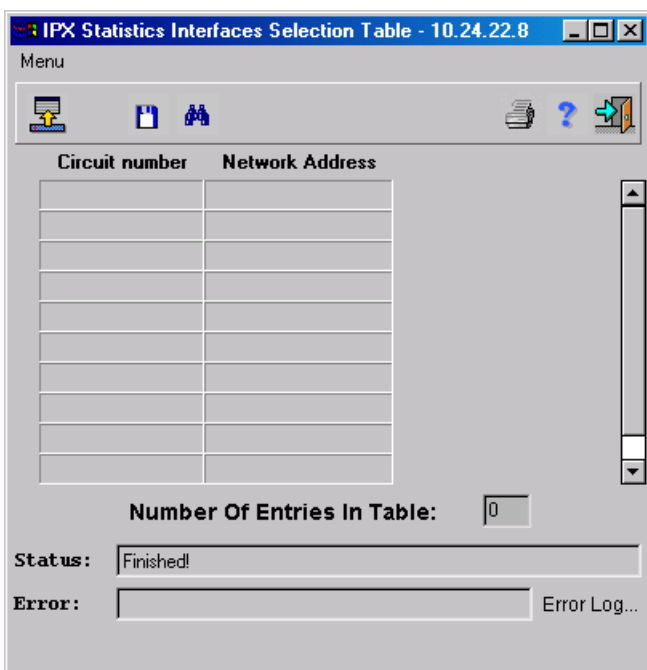



Figure 6- 194. IPX Statistics Interfaces Selection Table window

2. Select an entry and click. The **Element Statistics** window opens.
3. Select the MIB required variables by one of the following methods:
 - ◇ Double-click on the variable in the Optional Counters box. The variable is moved to the Selected box.

or

 - ◇ Select the variable in the Optional Counters box and click . The variable is moved to the Selected box.
4. Click . The graph opens.

Port Statistics

Displays a selected port or interface statistics.

To display Port Statistics:

1. Select a port by clicking on it. The port color changes to blue.
2. On the menu bar click **Statistics**,

or

Select **Statistics > Port Statistics**. The **IP Statistics Interface Selection Table** opens:

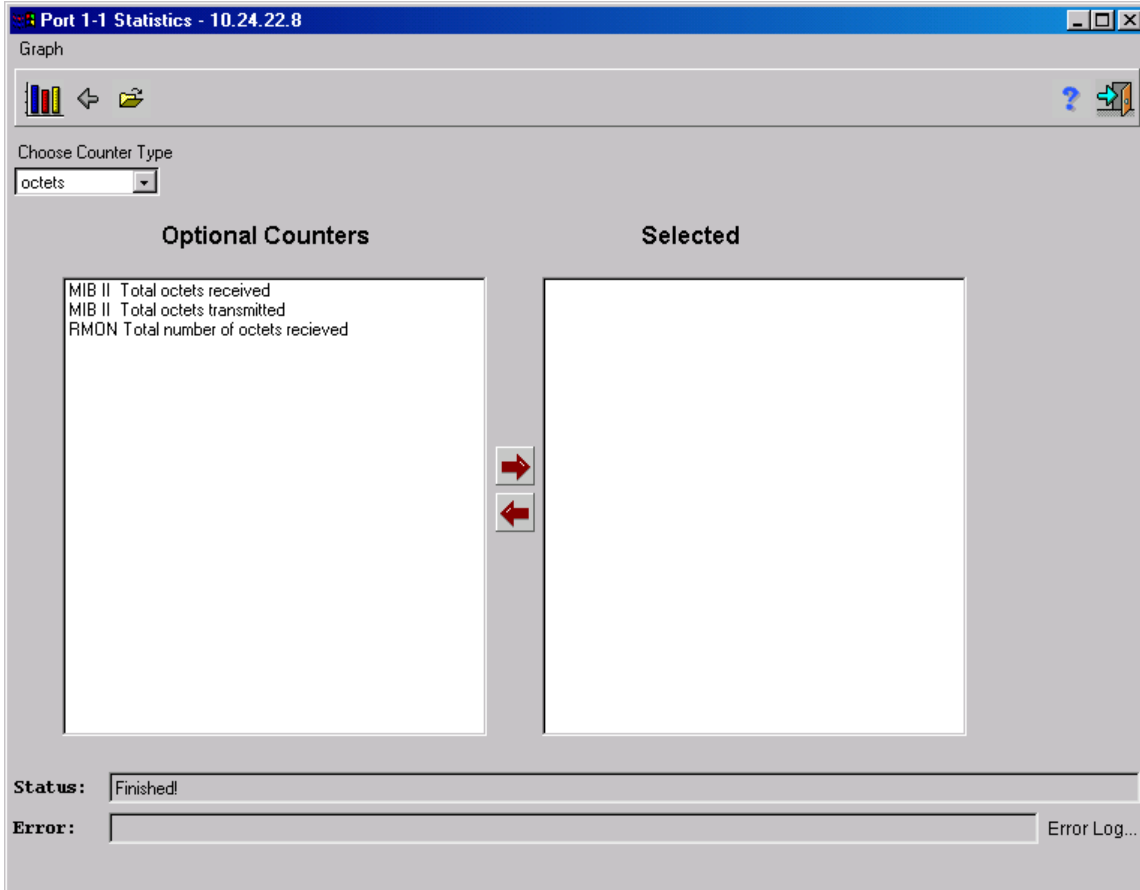



Figure 6- 195. Port Statistics window

1. Select the MIB required variables by one of the following methods:
 - ◇ Double-click on the variable in the Optional Counters box. The variable is moved to the Selected box.

or

 - ◇ Select the variable in the Optional Counters box and click . The variable is moved to the Selected box.
2. Click . The graph opens.

History

The **History** menu contains information about network statistics, and has the following menu options:

- ◆ History Control Table
- ◆ Ether History Table

History Control Table

The **History Control Table** contains information about samples of data taken from ports. For example, the samples may include interface definitions or polling periods.

To display the History Control Table:

- ◆ Select **Statistics > History > History Control Table**. The **History Control Table** opens:

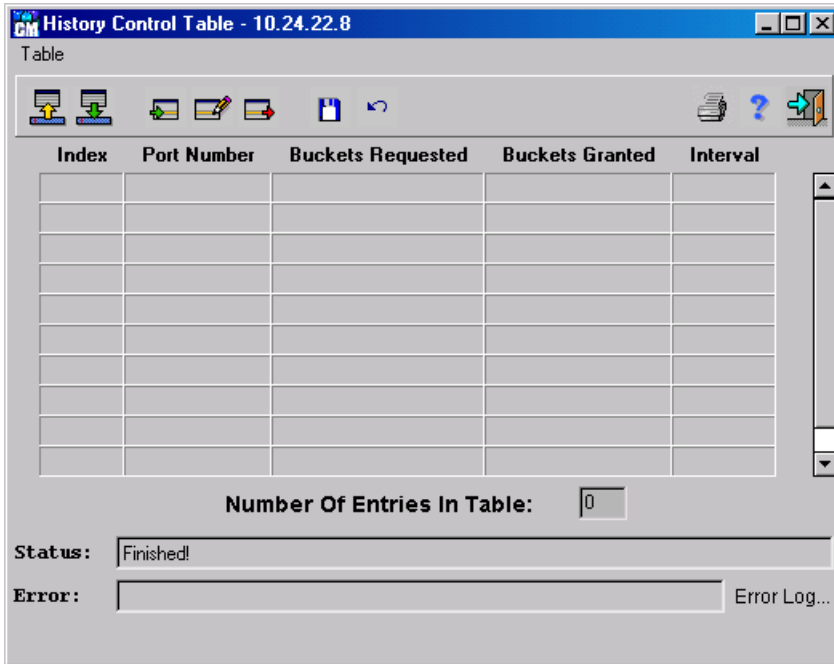



Figure 6- 196. History Control Table window

The **History Control Table** displays the following fields:

- ◆ **Index** – Specifies the History Control Table entry.
- ◆ **Port Number** – Specifies the port number from which the sample was taken.
- ◆ **Buckets Requested** – Indicates the number of times samplings are requested from the port. The default value is 50.
- ◆ **Buckets Granted** – Indicates the number of times samplings were requested from a port and the number of times the results were saved.
- ◆ **Interval** – Indicates in seconds the time that samplings are taken from the ports. The possible values are 1-3600 seconds. The default is 1800 seconds (30 minutes).

To add an History Control Table entry:

1. Display the **History Control Table**.
2. Select an entry in the table.
3. Click . The **History Control Table - Insert** window opens:

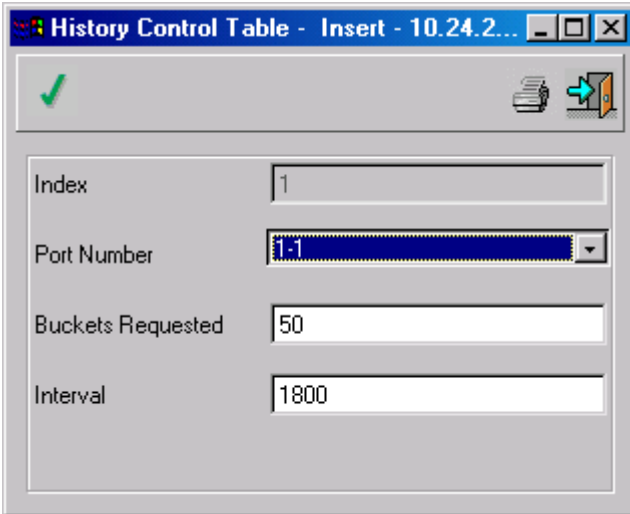



Figure 6- 197. History Control Table - Insert window

4. Complete the fields. The fields are the same as the **History Control Table** as described above.
5. Click . The **History Control Table Edit** window closes.

To edit an History Control Table entry:

1. Display the **History Control Table**.
2. Select an entry in the table.
3. Click . The **History Control Table Edit** window opens:

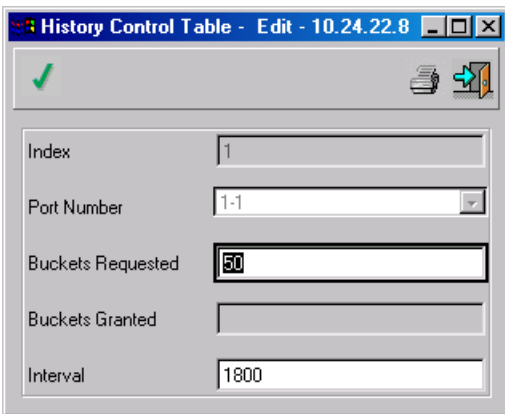





Figure 6- 198. History Control Table - Edit window

4. The **History Control Table - Edit** window parameters are described above.
5. Complete the fields.
6. Click .
7. Close the **History Control Table - Edit** window. The **History Control Table** opens.
8. Click . When the Status field displays “Finished!”, the fields are confirmed as modified.

To delete an History Control Table entry:

1. Display the **History Control Table**.

2. Select an entry in the table.
3. Click . The entry is deleted.
4. Click . When the Status field displays “Finished!”, the fields are confirmed as modified.

Ether History Table

The **Ether History Table** contains statistical network samplings. Each table entry represents a single sample. Samples reflect all packets on the local network segment.

To display the Ether History Table:

- ◆ Select **Statistics > History > Ether History Table**. The **Ether History Table** opens:

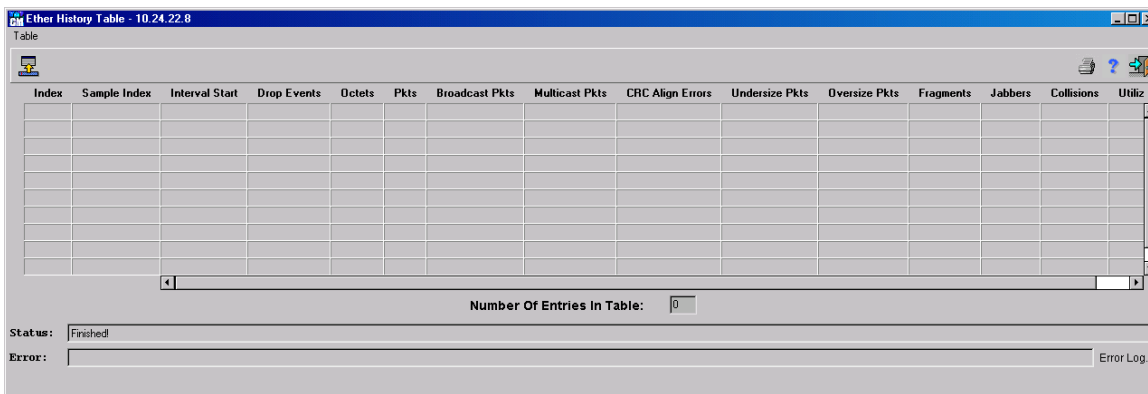

Figure 6- 199. Ether History Table window

The **Ether History Table** displays the following fields:

- ◆ **Index** – Specifies the *History Control Table* entry from which the sample was taken.
- ◆ **Sample Index** – Indicates the specific sample the information in the table reflects.
- ◆ **Interval Start** – Indicates the time at which the sample was taken. The Interval start time is represented in an hour, minute, and second format, for example, 5 hours, 26 minutes, and 2 seconds.
- ◆ **Drop Events** – Indicates the number of dropped packets due to lack of network resources during the sampling interval. This may not represent the exact number dropped packets, but rather the number of times dropped packets were detected.
- ◆ **Octets** – Indicates the number of data octets, including bad packets, received on the network.
- ◆ **Pkts** – Indicates the number of packets received during the sampling interval.
- ◆ **Broadcast Packets** – Indicates the number of good broadcast packets received during the sampling interval.
- ◆ **Multicast Packets** – Indicates the number of good multicast packets received during the sampling interval.
- ◆ **CRC Align Errors** – Indicates the number of packets received during the sampling session with a length 64-1,518 octets. However, the packets has a bad Frame Check Sequence (FCS) with an integral number of octets or a bad FCS with a non-integral number.
- ◆ **Undersize Packets** – Indicates the number of packets received less than 64 octets long during the sampling session.
- ◆ **Oversize Packets** – Indicates the number of packets received more than 1,518 octets long during the sampling session.

- ◆ **Fragments** – Indicates the number of packets received less than 64 octets long and had a FCS during the sampling session.
- ◆ **Jabbers** – Indicates the number of packets received more than 1,518 octets long and had a FCS during the sampling session.
- ◆ **Collisions** – Estimates the total number of packet collision that occurred during the sampling session. Collisions are detected when repeater ports detect two or more stations transmit simultaneously.
- ◆ **Utilization** – Estimates the main physical layer network usage on an interface during the session sampling. The value is reflected hundreds of percent.

Alarm Table

Displays a list of all alarm entries, created using the Element Statistics or the Port Statistics.

To generate Alarms based on the traffic handled by the device, the alarm is first set in the graph window.

To set an Alarm:

1. Display the **Element Statistics Graph** window.
2. In the Alarm Definition area click **New**. The **New Alarm** screen opens:

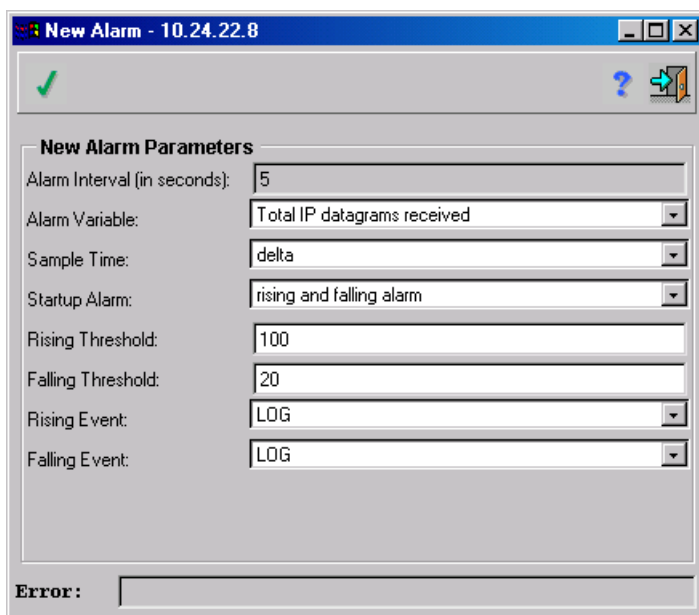

Figure 6- 200. New Alarm window

The **New Alarm** window displays the following parameters:

- ◆ **Alarm Interval** – The value used is Time (in seconds). The default is the value specified in the graph Sample Time parameter. Modifications are done by changing the Sample Time parameters. Sample Time settings are as follows:
 - ◇ Delta – Counter is reset.
 - ◇ Absolute – ROS monitors the counter for the defined interval.
- ◆ **Alarm Variable** – The selected MIB variable.
- ◆ **Sample Time** – There are two Sample Time settings:
 - ◇ Delta – The counter is reset at the times defined by the interval. This is the default.

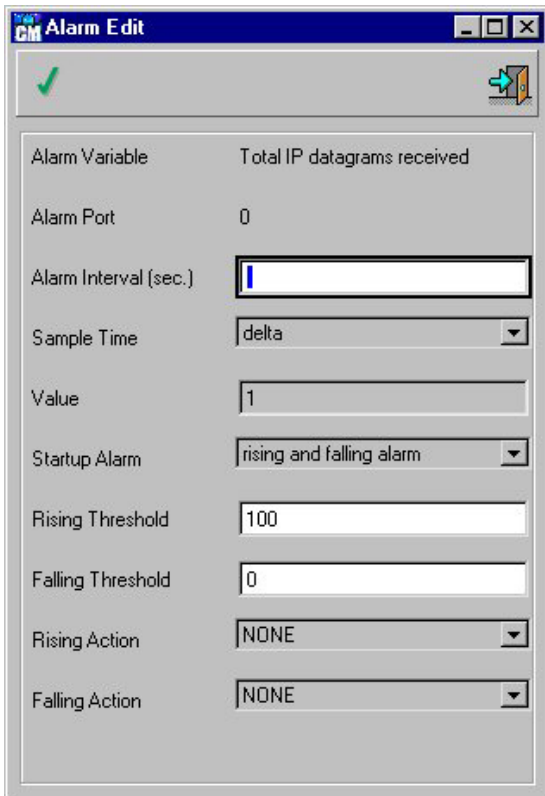





Figure 6- 202. Alarm Edit window

4. The **Alarm Edit** window parameters are described above.
5. Complete the fields.
6. Click .
7. Close the **Alarm Edit** window. The **Alarm Table** opens.
8. Click . When the Status field displays “Finished!”, the fields are confirmed as modified.

To delete an Alarm Table entry:

1. Display the **Alarm Table**.
2. Select an entry in the table.
3. Click . The entry is deleted.
4. Click . When the Status field displays “Finished!”, the fields are confirmed as modified.

Statistics Table

The **Statistics Table** consists of list of 17 RMON counters on selected ports.

To display the Statistics Table:

- ◆ Select **Statistics > Statistics Table**. The **Statistics Table** opens:

◆ Select **Statistics > Traps Table**. The **General Traps Table** opens:

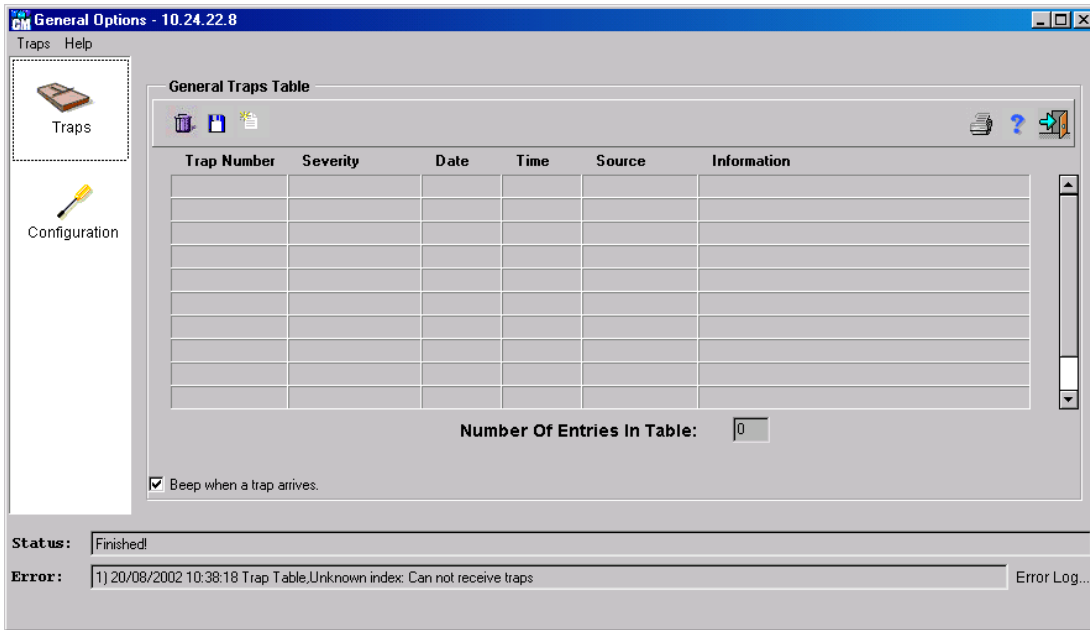

Figure 6- 205. General Options - General Traps Table window

The **General Options** window is divided into two panes, the left pane contains the screen functions, and the right pane contains corresponding function screen. The left pane always remains constant. Clicking on the function icons in the left pane toggles the right pane. In the **General Options** window left-hand pane, the following two icons are displayed:



Traps

The **General Options** window displays the **General Traps Table** by default. Tables displaying system signal traps.

Traps



Configuration

Displays the **General Options - Configuration** dialog box in the right pane. Used for modifying system configuration options.



Configuration

The **General Traps Table** window displays the following information:

- ◆ **Trap Number** – A consecutive number given to each event to make information retrieval more efficient.
- ◆ **Severity** – The event level, which can be one of the following:
 - ◆ Informational
 - ◆ Warning
 - ◆ Error
 - ◆ Fatal
- ◆ **Date** – Date the trap occurred.
- ◆ **Time** – Time the trap occurred.
- ◆ **Source** – The device IP address sending the trap.
- ◆ **Information** – An event description. For example, Link Up.

The **Traps Table** window has the following icons on the toolbar.

Traps Table Icons on the Toolbar

Icon	Function
	Delete Traps Table entries.
	Save the Traps Table. The Status bar displays the file path to which the trap has been saved: <ConfigMaster>/Nms/Configuration/traps.dat.
	Show Trap files.

To view the General Traps Table:

- There are two methods of displaying the **General Options** window is as follows:
 - ◆ From the **Main** window click **Options**.
 - ◆ On the Menu Bar, click **Statistics**. On the **Statistics** menu, click **Traps Table**. The **General Options** window opens. The default tab is **General Traps Table**.
- If the **Configuration** tab is open, click the traps icon in the left pane.

The **General Traps Table** opens in the right panel.

To view the Trap Files:

- ◆ On the **General Options - General Traps Table** window click. The **Saved traps** window opens:

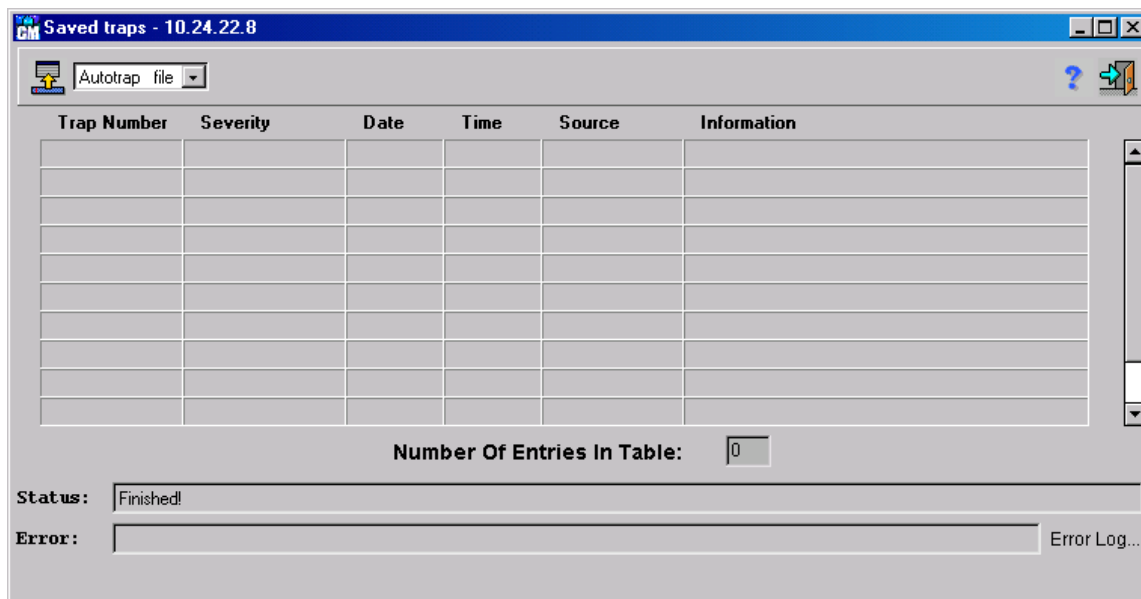

Figure 6- 206. Saved traps window

The columns displayed in the **Saved traps** window are the same as displayed in the **General Options - Traps Table**.

There are two types of **Saved traps** tables:

- ◆ Autotrap File
- ◆ Trap File

To view the device front panel from the trap source:

Double-click a trap in the Traps Table to open the device front panel view that sent the trap.

To set an alarm when receiving traps:

Click the “Beep when a trap arrived” checkbox to hear the beep every time a new trap arrives.

Configuring Trap Parameters

To configure the number of traps displayed in the Traps Table and how many traps stored in a file:

- ◆ From the **General Options** window Menu Bar, click **Traps** and then select **Traps Configuration**. The following **Traps Configuration** window opens:

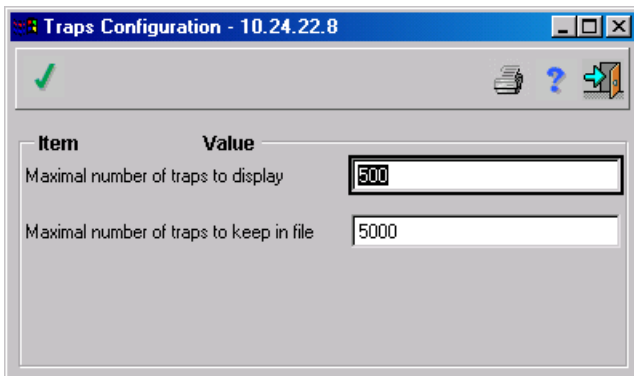

Figure 6- 207. Traps Configuration window

The following parameters are displayed in the **Traps Configuration** window:

- ◆ **Maximal number of traps to display** – How many traps are displayed in the Traps Table. By default, 500 traps can be displayed.
- ◆ **Maximal number of traps to keep in file** – How many traps to store in a file. The default value is 5000, i.e. 5000 traps are stored by the system in the file called `autotraps.dat`.

The maximal number of traps to keep on file must be greater than the maximal number of traps to display. For example, with maximal number of traps to display set to 100 and maximal number of traps to keep in file is set to more than 100.

If 150 new traps arrive, the most recent 100 traps are displayed in the Traps Table and the rest of the new traps (50 traps) are stored in the `autotraps.dat` file.

Enter the two parameters and press. The configuration is saved and the Traps Table opens.

Log Table

The **Statistics log table** consists of entries generated by a device when triggering events. Those events are triggered once the traffic crosses a threshold, by either Falling or Rising actions, set to LOG or LOG and TRAP.

This table is read only, therefore only the logged entries can be viewed. The logged entries are cleared once the device is reset. To save these entries, use the TRAPS function.

To generate the Statistics Log Table:

- ◆ Select **Statistics > Log Table**. The **Statistics log table** opens:

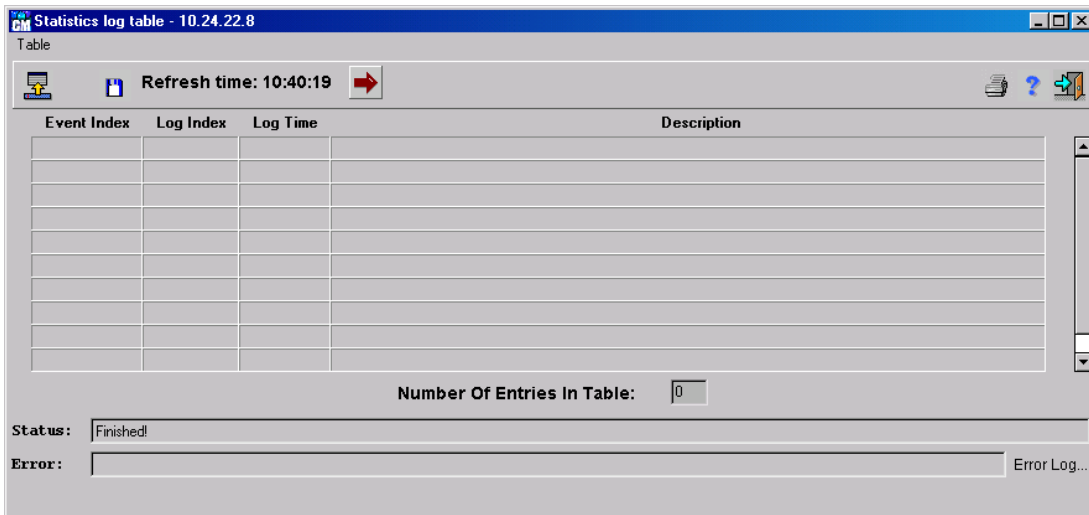

Figure 6- 208. Statistics log table window

Working With Services

The **Services** command has the following menu options:

- ◆ Device Tuning
- ◆ Event Log
- ◆ Refresh
- ◆ Polling Configuration
- ◆ Community Change
- ◆ Ping
- ◆ Refresh Device Version

Device Tuning

Device Tuning is used to determine the maximum amount of entries allowed in the various tables listed. The changes are implemented only after reset.

To display the Device Tuning window:

- ◆ Select **Services > Device Tuning**. The **Device Tuning** window is displayed. There are four tabs on the **Device Tuning Window**.
- ◆ **General** – Defines the maximum number of entries for the Bridge Forwarding table, RMON Log table, and the Error Report table.
- ◆ **IP** – Defines the maximum number of entries for RIPv2s, ARP Forwarding table, FFT table, DHCP connections, and the FFT upper and lower limits.
- ◆ **IPX** – Defines the maximum number of entries for RIP, SAP, and FFT upper and lower limits.
- ◆ **IPM** – Defines the maximum number of entries for FFT, PIM, and IGMP entries both before and after the device is reset.

To display the Device Tuning window General tab:

- ◆ Select **Services > Device Tuning**. The **Device Tuning** window opens. The default screen is the **General** tab.

The **General** tab displays the following columns:

- ◆ **Current Value** – The current maximum number of entries.
- ◆ **After Reset** – The future (after reset) maximum number of entries. By entering a value in the After Reset column, memory is allocated to the field table.

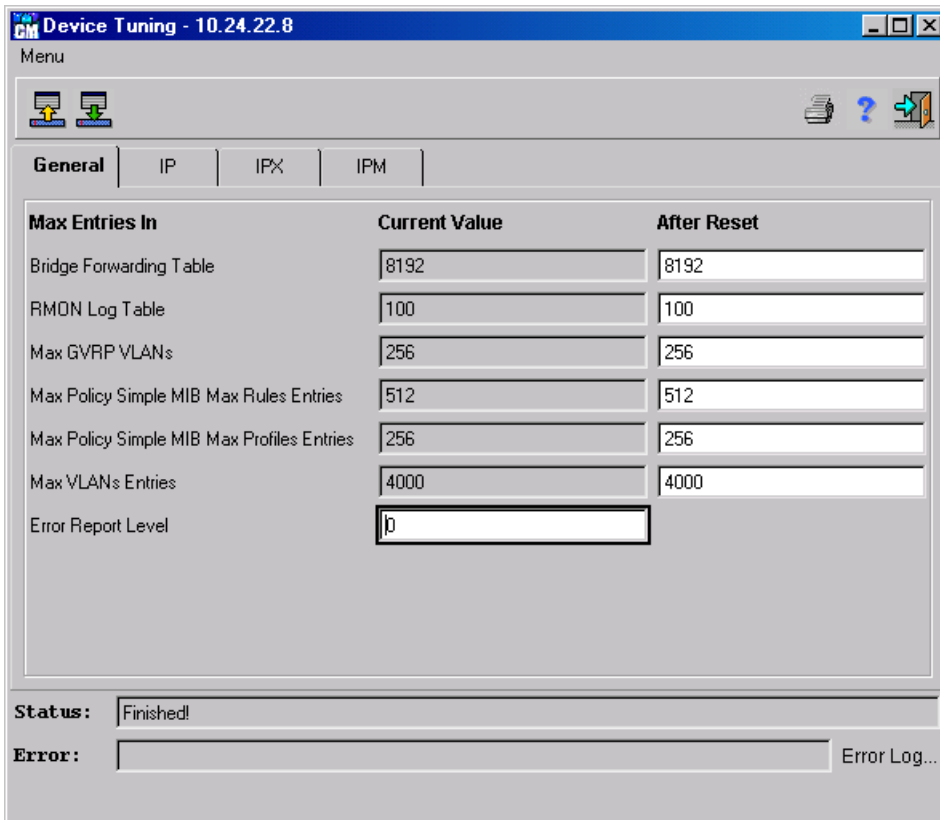

Figure 6- 209. Device Tuning window General tab

The **Device Tuning window General** tab displays the following parameters:

- ◆ **Bridge Forwarding Table** – Maximum number of entries (MAC addresses) possible for this table.
- ◆ **RMON Log Table** – The number of log entries the device keeps in the table before overwriting the first entry. It is kept until the device is reset.
- ◆ **Max GVRP VLANs** – Indicates the maximum number of VLANs that can currently participate in GVRP.

Note: *If the maximum number of VLANs is decreased, the number should still be greater than the number of MAX GVRP VLANs.*

- ◆ **MAX Policy Simple MIB Max Rules Entries** – Indicates the maximum number of policy entries.
- ◆ **MAX Policy Simple MIB Max Profile Entries** – Indicates the maximum number of profile entries.
- ◆ **Max VLANs Entries** – Indicates the maximum number of VLANs entries.
- ◆ **Error Report Level** – (0 to 255) Determines the amount of errors sent to the terminal. 0 sends the least amount of errors and 255 sends the most.

To display the Device Tuning window IP tab:

1. Display the **Device Tuning** window's **General** tab.
2. Select the **IP** tab. The **IP** tab opens:

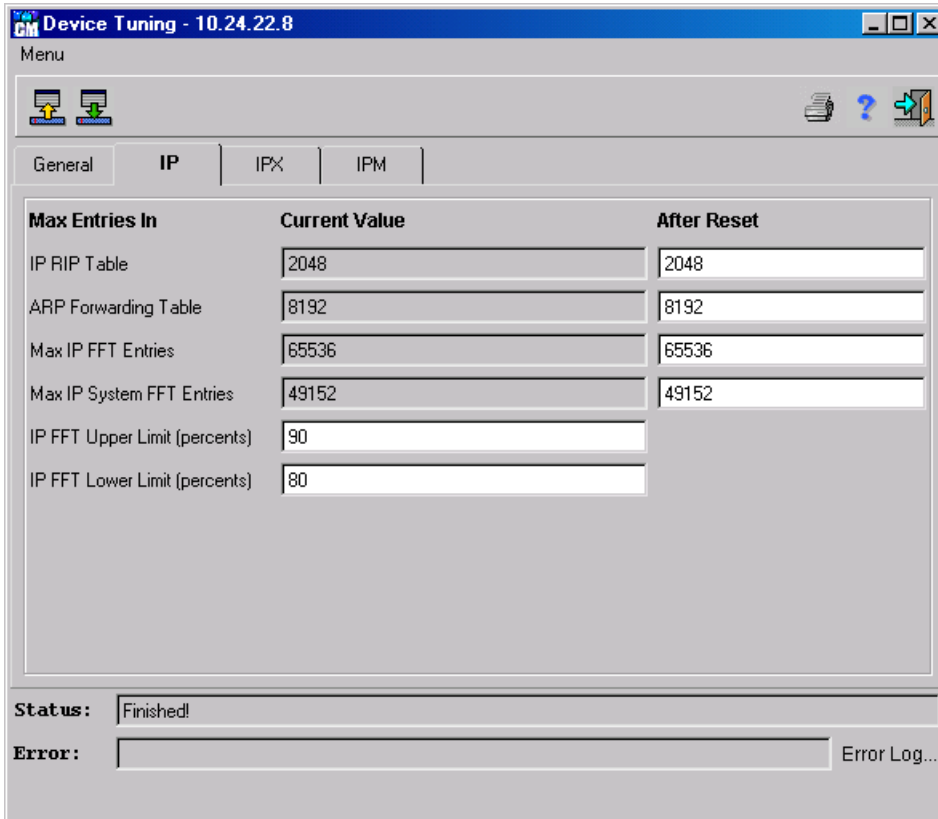

Figure 6- 210. Device Tuning window IP tab

The **IP** tab displays the following parameters:

- ◆ **IP RIP table** – Maximum number of routing table entries allowed for this table.
- ◆ **ARP Forwarding table** – Maximum number of entries allowed for this table.
- ◆ **Max IP FFT Entries** – Maximum number of IP Fast Forwarding table entries allowed.
- ◆ **Max IP System Entries** – Maximum number of IP entries that can be entered into the system.
- ◆ **IP FFT Upper Limit (percents)** – Maximum percentage of entries that the device can hold in FFT without overflowing.
- ◆ **IP FFT Lower Limit (percents)** – Minimum percentage of entries in which the device would stop the overflowing process.

To display the Device Tuning window IPX tab:

1. Display the **General** tab.
2. Select the **IPX** tab. The **IPX** tab opens:

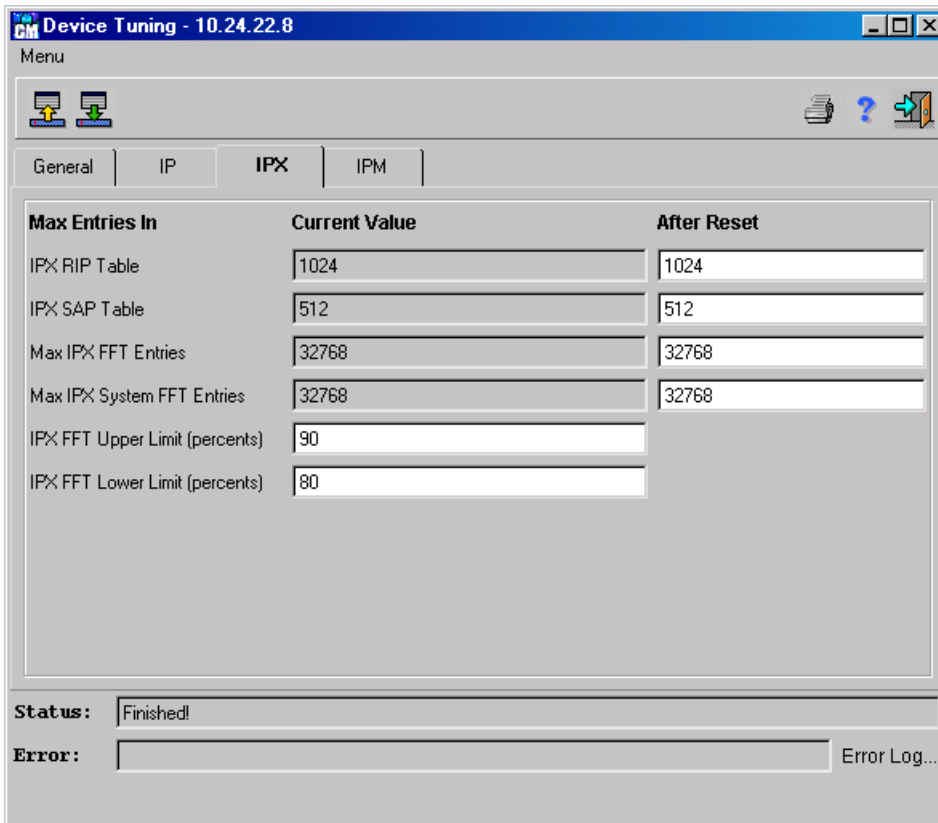

Figure 6- 211. Device Tuning window IPX tab

The **IPX** tab displays the following parameters:

- ◆ **IPX RIP Table** – Maximum number of routing table entries allowed for this table.
- ◆ **IPX SAP Table** – Maximum number of server entries allowed.
- ◆ **Max IPX FFT Entries** – Maximum number of IPX Fast Forwarding table entries allowed.
- ◆ **Max IPX System FFT Entries** – Maximum number of IPX entries that can be entered into the system.
- ◆ **IPX FFT Upper Limit (percents)** – Maximum percentage of entries the device can hold in FFT whiteout flowing.
- ◆ **IPX FFT Lower Limit (percents)** – Minimum percentage in which the device would stop the overflowing process.

To display the Device Tuning window IPM tab:

1. Display the **General** tab.
2. Select the **IPM** tab. The **IPM** tab opens:

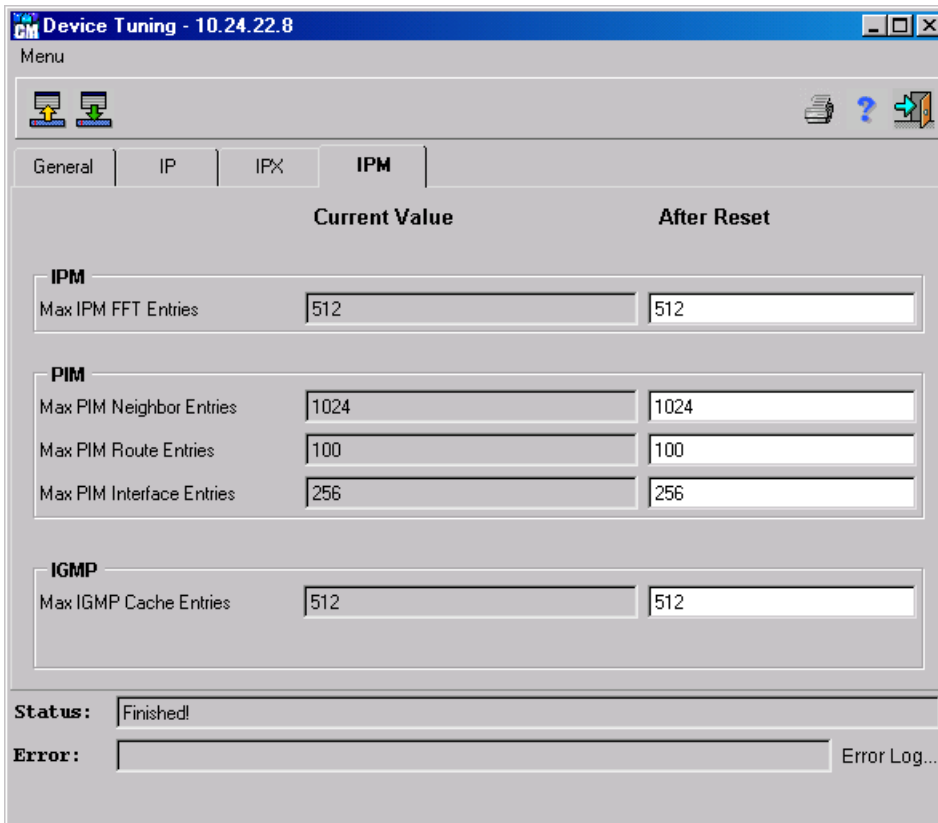

Figure 6- 212. Device Tuning window IPM tab

The **IPM** tab displays the following parameters:

- ◆ **Max IPM FFT Entries** – Maximum number of Fast Forwarding Table entries allowed both currently and after reset.
- ◆ **Max PIM Neighbor Entries** – Maximum number of PIM Neighbor entries allowed both currently and after reset.
- ◆ **Max PIM Route Entries** – Maximum number of PIM Route entries allowed both currently and after reset.
- ◆ **Max PIM Interface Entries** – Maximum number of PIM Interface entries allowed both currently and after reset.
- ◆ **Max IGMP Cache Entries** – Maximum number of IGMP Cache entries allowed both currently and after reset.

Event Log

The **Event Log** window records all device internal errors, including the date and time of occurrence, and a brief error description.

To display the Event Log:

- ◆ Select **Services > Event Log**. The **Event Log** window opens:

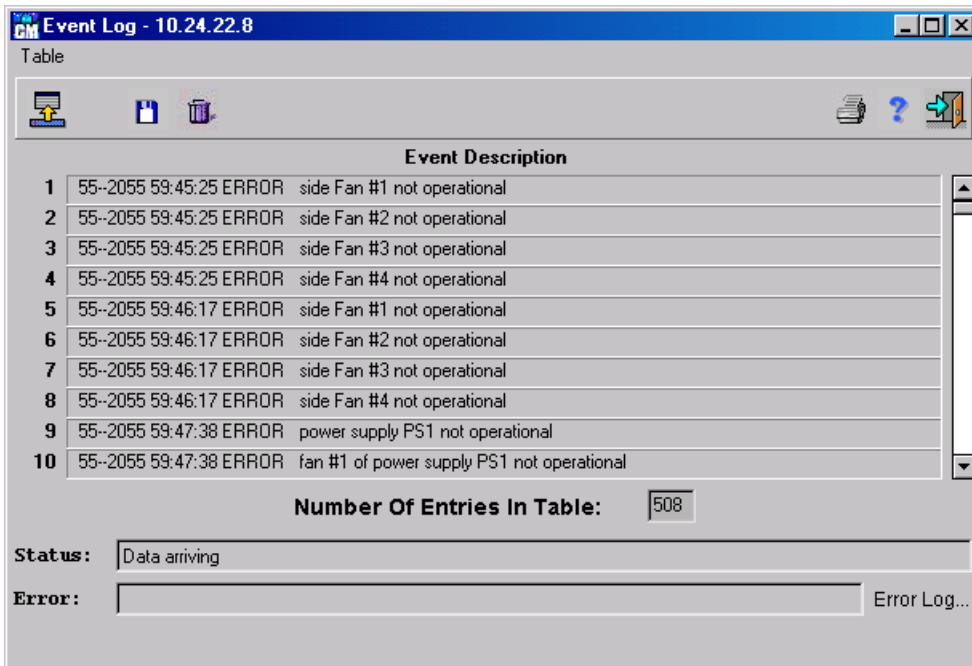



Figure 6- 213. Event Log window

Refresh

To refresh the front panel view:

- ◆ Select **Services > Refresh**.
- or
- ◆ Press **Ctrl+R**.
- or
- ◆ Click . The front panel view is refreshed.

Polling Configuration

Use this window to define how often (in milliseconds) the device is polled via SNMP protocol.

To define the SNMP polling frequency:

1. Select **Services > Polling Configuration**. The **Polling Configuration** window opens:

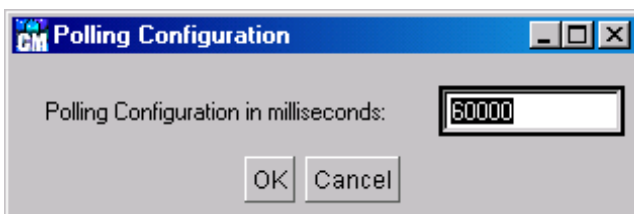

Figure 6- 214. Polling Configuration window

2. Enter the required polling configuration.
3. Press **OK**.

Community Change

The system administrator manages access rights (read and write, read only, etc.) by making communities in the device, in the Community table. When the community name is changed, the access rights are changed.

To change a device community name:

1. Select **Services > Community Change**. The **Community Change** window opens:

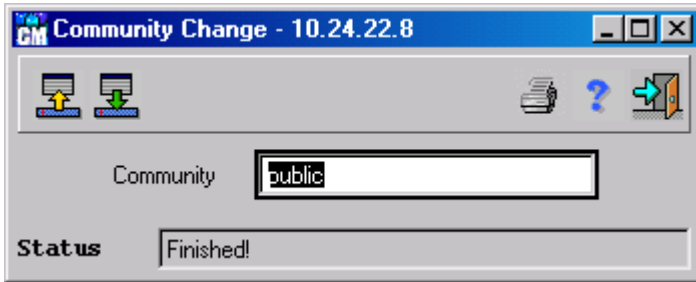

Figure 6- 215. Community Change window

2. Type in the new community name.

Note: Type in the new community name exactly as it appears in the system administrator Community Table or the station with Super access. Any incorrect community name is accepted by the Community Change window, but access to read or write data is unavailable.

3. Click . The status bar displays the message: “Community was changed!”. The system has the appearance of exiting and re-starting.

Ping

The **Ping Table** displays a list of addresses of devices that were pinged by the system.

To display the device Ping Table:

- ◆ Select **Services > Ping**. The **Ping Table** opens:

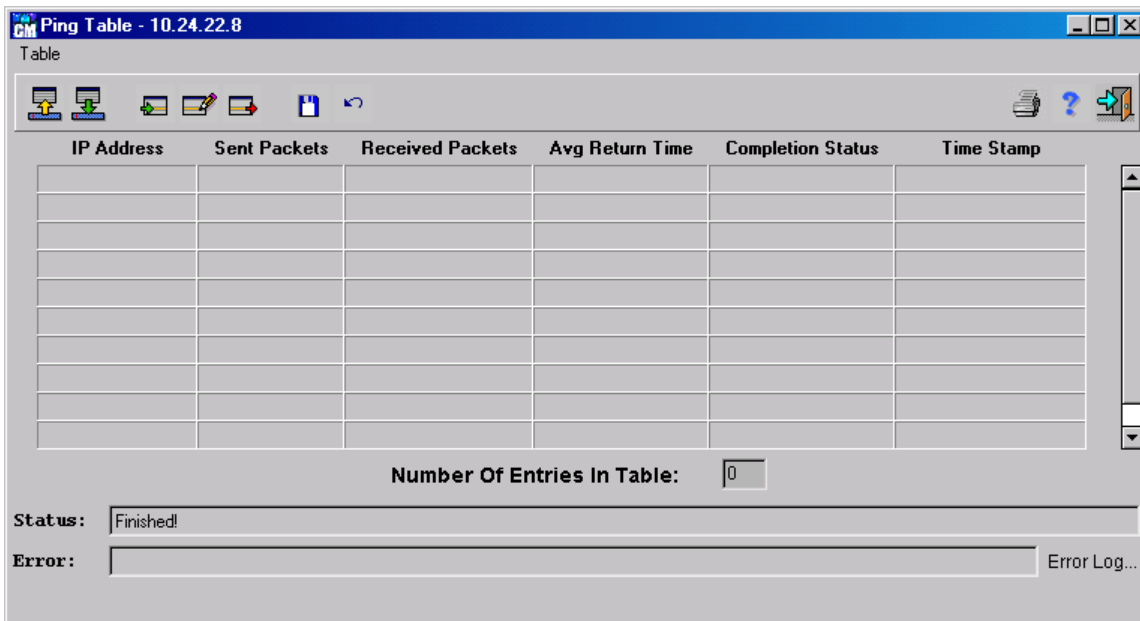



Figure 6- 216. Ping Table window

The **Ping Table** displays the following parameters:

- ◆ **IP Address** – The device address pinged.
- ◆ **Sent Packets** – The number of packets sent to the device.
- ◆ **Received Packets** – The number of packets received from the device.
- ◆ **Avg Return Time** – The average amount of time it took for data to return from the device.
- ◆ **Completion Status** – The ping operation status, such as OK for a successful ping, or Timeout for a ping operation that resulted in a timeout.
- ◆ **Time Stamp** – Indicates the time and date the ping operation was requested or changed.

To add an entry in the Ping Table:

1. Display the **Ping Table**.
2. Click . The **Ping Table Insert** window opens:

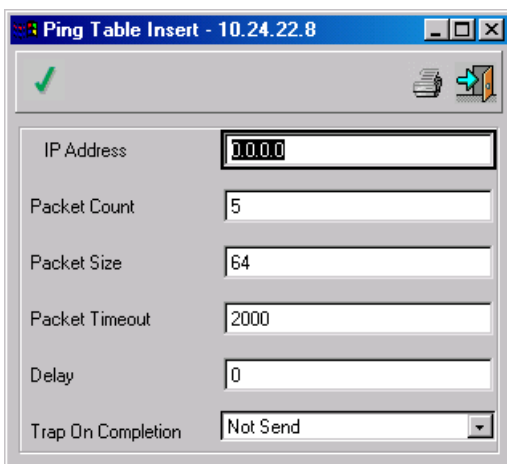



Figure 6- 217. Ping Table Insert window

The **Ping Table Insert** window displays the following parameters:

- ◆ **IP Address** – The device address to be pinged.
- ◆ **Packet Count** – The number of packets delivered in the ping operation.
- ◆ **Packet Size** – The size of each packet delivered to the device.
- ◆ **Packet Timeout** – The amount of time the system waits until it stops sending the packet.
- ◆ **Delay** – The amount of time the system waits between the last packet it sent, and the next packet to be sent in the sequence.
- ◆ **Trap on Completion** – Whether or not to send traps to the management station after ping is completed.

3. Complete the fields.
4. Click .
5. Close the **Ping Table Insert** window. The **Ping Table** opens.
6. Click . When the Status field displays “Finished!”, the fields are confirmed as modified.

To edit a line in the Ping Table:

1. Display the **Ping Table**.
2. Select an entry in the table.

- Click . The **Ping Table Edit** window opens:

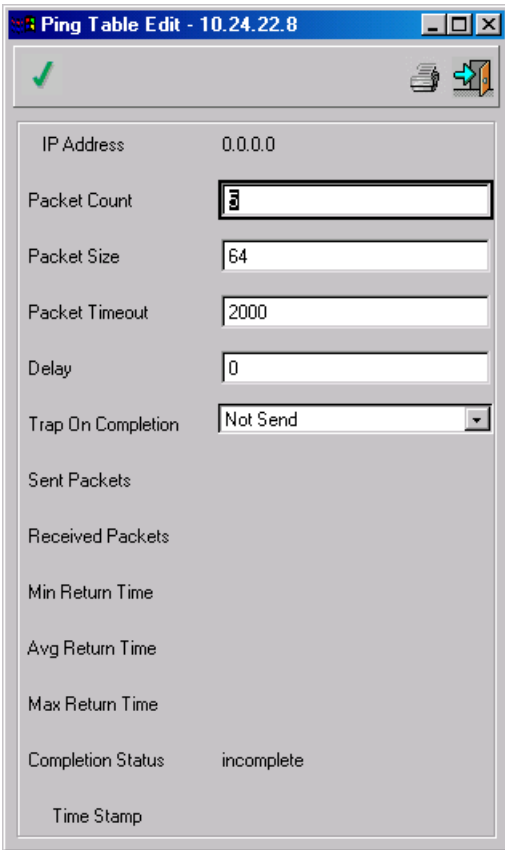





Figure 6- 218. Ping Table Edit window

- Complete the fields as required.
- Click .
- Close the **Ping Table Edit** window. The **Ping Table** opens.
- Click . When the Status field displays “Finished!”, the fields are confirmed as modified.

To delete edit a line in the Ping Table:

- Display the **Ping Table**.
- Select an entry in the table.
- Click . The entry is deleted.
- Click . When the Status field displays “Finished!”, the fields are confirmed as modified.

Refresh Device Software

This command is used to verify that the device front panel view is updated according to the current software version.

To refresh the device:

- Select **Services > Refresh Device Version**. The **Check Version for** window opens:

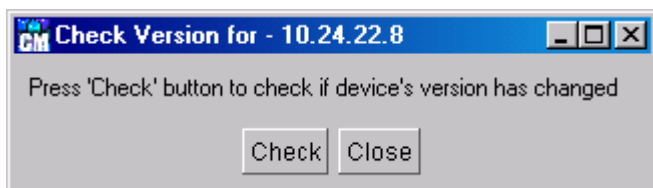

Figure 6- 219. Check Version for window

If a later device software version is installed since the last time the system was initiated, the system closes the current front panel view and all open windows, and re-opens a refreshed front panel view.

TECHNICAL SPECIFICATIONS

General		
Standards	IEEE 802.3 10BASE-T Ethernet IEEE 802.3u 100BASE-TX Fast Ethernet IEEE 802.3z 1000BASE-SX/LX Gigabit Ethernet IEEE 802.1ab 1000BASE-T Gigabit Ethernet IEEE 802.1P/Q IEEE 802.3x RFC 1123, RFC 2236 RFC 1493, RFC 951 RFC 2131, RFC 1058 RFC 1723, RFC 1389 RFC 1253, RFC 1583 RFC 2178, RFC 1850 RFC 1112, RFC 2236	
Management	MIB II, RMON, SNMP	
Protocol	CSMA/CD	
Data Transfer Rate	Half-duplex	Full-Duplex
Ethernet	10 Mbps	20 Mbps
Fast Ethernet:	100 Mbps	200 Mbps
Gigabit Ethernet:	n/a	2000 Mbps
Topology	Star	
Network Cables	2-pair Category 3/4/5 UTP (max. 100 m) EIA/TIA-568 100-ohm STP (max. 100 m)	
10BASE-T:		
100BASE-TX:	2-pair Category 5 UTP (max. 100 m) EIA/TIA-568 100-ohm STP (max. 100 m)	
1000BASE-T	2-pair Category 5 UTP (max. 100 m) EIA/TIA-568 100-ohm STP (max. 100 m)	

Physical and Environmental	
AC Input	90 to 264 VAC, 47-63 Hz (auto-adjusting internal power supply)
AC Output	3.3V, 80A
DC Fans	Two built-in 60 x 60 mm fans per power supply unit
Temperature	Operating: 0° to 40° C (32° to 104° F) Storage: -25° to 55° C (-13° to 131° F)
Relative Humidity	Operating: 5% to 95% (non-condensing) Storage: 0% to 95% (non-condensing)
Dimensions	H: 35.6 cm (14.01 in.) W: 44.0 cm (17.32 in.) D: 29.4 cm (11.57 in.)
Weight	12.68 kg (case + power + DES-6301 + DES-6302 w/ bracket) power 2.25 kg empty slot bracket 110g DES-6303 0.98 kg DES-6304 1.03 kg DES-6305 1.02 kg DES-6306 0.98 kg DES-6307 0.98 kg DES-6308 0.98 kg DES-6309 (w/ GBIC Fiber Transceiver) 1.05 kg
EMI	FCC Class A, CE Class A, VCCI Class A, BSMI Class A, C-Tick Class A
Safety	UL/CUL, TUV, CE

SAMPLE CONFIGURATION FILE

This appendix provides a sample configuration file that can be used with the **Update Firmware and Configuration Files** screen in the console program.

The configuration file is a simple text file that you create. It has two functions: to point to the location of a file on a TFTP server, and to set the IP address, subnet mask and default gateway for the Switch. The file being uploaded can be either new runtime switching software, or a switch settings file that was previously saved on the TFTP server using the **Save Settings to TFTP Server** screen on the **System Utilities** menu. The IP address settings defined in the configuration file will override all other IP settings, even those defined in the settings file being uploaded. This enables the settings from one switch to be uploaded to another switch without their IP settings being the same (and thus coming into conflict).

Commands:

- ◆ `Code_type` – This command tells the Switch the type of file you wish to upload to the Switch. Possible `Code_types` are PROM, RUNTIME, or CONFIG. This should always be the first setting.
 - PROM – PROM update file.
 - RUNTIME – Switching software update file.
 - CONFIG – Image file of switch settings created by the settings backup procedure.
- ◆ `Image_file` – This command tells the switch the complete path and filename for the file to be loaded into the switch. For example, “e:\6300\6300prom.tfp”. Make sure double-quotes are used as in the example file below.
- ◆ `Ip_addr` – This is the IP address that will be assigned to the switch. This command is included for downloading a configuration settings file to another switch. The IP address defined in this file will override the IP address in the configuration settings file, thus the switch you are downloading to can have a different IP address than the one that created the configuration settings file. An example of an IP address is: 10.12.19.102.
- ◆ `Subnet_mask` – This is the subnet mask that will be assigned to the switch. An example of a subnet mask is: 255.128.0.0.
- ◆ `Default_gateway` – This is the default gateway IP that will be assigned to the switch. An example of a default Gateway IP is: 10.254.254.253.
- ◆ `#` – Remark. When placed as the first character on a line, the entire line will be ignored by the switch. This allows items to be labeled, or unused commands to remain in the file so that the syntax will not be forgotten.

Notes about the Configuration File:

This configuration file can only contain 4 settings: `Code_type`, `Ip_addr`, `Subnet_mask` and `Default_gateway`.

Each command can only appear once in the configuration file.

If both the Firmware Update and Use Config File options are enabled, the Firmware Update command will take precedence and only the firmware file will be uploaded to the switch.

The Config image file, which contains all configuration settings and was created by the switch is prefixed with the version number of the runtime software to help with file management.

```
# Sample Config File
```

```
Code_type=PROM
```

```
Image_file="e:\6300\6300prom.tfp"
```

```
# specify IP address
```

```
Ip_addr = 10.12.19.102
```

```
# specify subnet mask
```

```
Subnet_mask = 255.128.0.0
```

```
# specify default gateway
```

```
Default_gateway = 10.254.254.253
```

INDEX

100BASE-TX networks	7	Device	45
100Mbps Fast Ethernet	6	Port Mirroring	86
AC power cord	11	Device Error	46
Accessory pack	11	Device Global Parameters	69
Aging Time		Device Port Properties	80, 87
very long	26	Device set as default	57
very short	26	Device Software Refresh	237
Aging Time, definition of	26	Device Tuning - General tab	230
Aging Time, range of	26	Device Tuning - IP tab	231
Alleviating network loop problems	28	Device Tuning - IPM tab	232
ASCII format	44, 66	Device Tuning - IPX tab	231
Attaching the mounting brackets	<i>See</i> Rack	Dynamic filtering	26
Installation		Edit Device List	56
Automatic learning	26	Editing Table rows	62
Automatic topology re-configuration		Egress port	32
Spanning Tree Algorithm	26	Element Statistics	210
Autotraps.dat	53, 228	Erasing Tables	64
BadPackets SNMP	210	Error Bar	50
BER format	44, 66	Error Log	46
Bridge	100	Fast Ethernet Technology	6
Rapid Spanning Tree	113	File-Configuration File	64
Spanning Tree	104	Filtering Database	26
Unicast	101	Forward Delay	29
Bridge Level, STA Operation Level		Front Panel	15
Bridge Identifier	27	Global Parameters	
Bridge Priority	27	Contact Person	69
Designated Bridge	27	Hardware Software version	70
Root Bridge	27	Identification	69
Root Path Cost	27	Name	69
Bridge Operating Parameters	100	Software version	70
Bridge Priority	29	Time	70
Cascade Windows	45	Global Parameters	
Community	45	Location	69
ConfigMaster Introduction	36	GUI	36, 48
ConfigMaster.bat	43	GVRP Information	94
Configuration File Name	65	GVRP Parameters	90
Configuration File TFTP Server Address	65	GVRP Timers Control	92
Connect Button	45	Hardware requirements	37
Connecting The Switch	21	heat dissipation	11
Converting files from BER to ASCII	44, 66	Hello Time	29
Copy Port	87	Hub to Switch, connecting the	21
CSMA/CD Ethernet protocol	6	Identifying External Components	15–20
DECNet	210	IGMP	157
Delete Device	57	Cache Table	160
Deleting Table rows	63	Interface Table	158
Desktop or Shelf Installation	11	Operating Parameters	157

Illustration of STA	28	Lower Bridge Identifier	27
Ingress port	32	MAC-based VLANs	30
Inserting Table rows	63	Main Window	45
Installation requirements	37	Main Window options	45
IP Addresses and SNMP Community Names ..	24	Management Information Base (MIB)	25
IP ARP table	146	Max. Age Time	29
IP DHCP	150	Menu Bar	49
IP DHCP Parameters	150	MIB's Object-Identity (OID).....	25
IP Interface Parameters ..121, 128, 129, 130, 136,		Mirrored Port	87
137, 140, 141, 142, 144, 146, 149, 150		Modify Device information	57
Address	122	Network loop detection and prevention	
Broadcast Type	122	Spanning Tree Algorithm	26
Forward Broadcast	122	On-line Help	45
ICMP Parameters	123, 124	Options Configuration	53
If Number	122	OSPF Interface Parameters table Edit	138
Network Mask	122	Overview of this User's Guide	v
OSPF Parameters	123, 126	Packet Forwarding	25
RIP Parameters	123, 125	Parameters	
IP Operating Parameters	121	Bridge Type	100
IP OSPF Area table	139	Software Type	67
IP OSPF II	135	System Date	70
IP OSPF Link State Database	140	System Time	70
IP Parameters		Ping table	235
ARP Proxy	121	Polling Configuration	234
ICMP error messages	121	Port Context menu	60
Inactive ARP Time Out	121	Port Level, STA Operation Level	
Redundancy Admin Status	121	Designated Port	27
IP RIP Filter	130	Path Cost	27
IP RIP Global Filter	131	Port Priority	27
IP RIP Interface Filter	134	Root Bridge	27
IP Statistics	215	Port Priority	29
IP TCP Connection table	155	Port Statistics	217
IP TCP General Parameters	155	Port Trunking	29
IP UDP Relay table	152	Port-based VLANs	31
IPM		Power Failure	14
PIM	164	Power LEDs	59
PIM Parameters	164	QoS	196
Routing Parameters	157	Rack Installation	12
Routing Table	170	Rapid Spanning Tree	113
IP-OSPF Interface Parameters	137	Rapid STP Port Table	113
IPX RIP Circuit Filter	181	RSTP Force Software version Table	115
IPX RIP Global Filter	178	Read-only MIBs, Definition of	25
IPX Routing table	188	Read-write MIBs, Definition of	25
IPX SAP Circuit Filter	185	Reset Device	68
IPX SAP Global Filter	183	Router	120
IPX SAP table	191	Router IP	120
IPX Statistics	217	Router IPX	174
Join Time	93	Routers	7
Leave All Time	93	Running the BER/ASCII converter without	
Leave Time	93	Running ConfigMaster	44
LED Indicators	19	Security Community table	194
Legend	214		

Segments, Network.....	7	Trap Number.....	52, 226
Services.....	229	Trap Severity	52, 226
Services Community Change	235	Trap Source.....	52, 226
Services Device Tuning.....	229	Trap Type	
Services Event Log.....	233	Authentication Failure	25
Setting Options	50	Cold Start.....	24
Setup	11	Link Change Event	25
Sharing Resources Across VLANs.....	31	Traps	24
Shortcuts	61	Traps displayed.....	53, 228
SNMP/TFTP Configuration.....	54	Traps stored	53, 228
SNMP/TFTP Retries Field	54	Traps Table	51
SNMP/TFTP Timeout Field.....	54	Traps, definition of.....	24
Software requirements.....	37	Troubleshooting.....	43
Spanning Tree		Cannot View Tables When Using A Browser.....	44
Spanning Tree Parameters	104, 110	ConfigMaster.bat does not activate ConfigMaster.....	44
Spanning Tree Port Table	108	<i>Disabling a Proxy Server</i>	44
Spanning Tree Algorithm (STA).....	26	Local Internet Use.....	44
STA Operation Levels	27	Poor Web Performance With Windows 95.....	43
On the Bridge Level.....	27	Very Slow Directory Discovery.....	43
Standard MIB-II.....	25	Unicast.....	101
Statistics.....	210	Global Forwarding	101
Statistics Alarm table.....	222	Unicast Forward Table	103
Statistics Graph.....	212	Uninstalling ConfigMaster	43
Statistics Graph - Alarm Definitions	215	Unknown Device Error.....	47
Statistics Graph - Display Configuration.....	214	Unpacking.....	11
Statistics Graph - Display Controls	215	Unpacking and Setup.....	11–14
Statistics Graph - Graph Area.....	214	Untagging	32
Statistics Graph - Graph Controls.....	214	User-Changeblel Parameters	
Statistics Graph - Legend.....	214	Bridge Forward Delay	28
Statistics Graph - Menu Bar	213	Bridge Hello Time	27
Statistics Graph - Other Controls.....	215	Bridge Max Age	28
Statistics Graph - Tool Bar	214	Bridge Priority	27
Statistics Interface Statistics	215	Port Priority	28
Statistics Log table.....	228	User-Changeblel Parameters	27
Statistics table.....	224	ventilation	11
Status Bar.....	50	Version Check	60
Switch Management Concepts	24	Version Unknown Error	47
Switch to 10 Base-T hub, connecting the	21	VLAN	30
Switch to 100Base-TX hub, connecting the	22	VLAN Port Based.....	74, 75, 78
Switching Technology.....	7	VLAN Protocol Based.....	78
Tables.....	62	VLAN Segmentation	31
Tagging.....	32	VLANs Spanning Multiple Switches	32
Third-party vendors' SNMP software	25	Zoom View	36
Toolbar Icons	49	Zoom View color-codes	58
Trap Configuration	52, 228	Zoom View LEDs.....	59
Trap Date and Time	52, 226	Zoom View Open	57
Trap Information.....	52, 226	Zoom View Refresh.....	234
		Zoom View Refreshing.....	60

D-Link Offices

- Australia** **D-Link Australasia**
Unit 16, 390 Eastern Valley Way, Roseville, NSW 2069 Australia
TEL: 61-2-9417-7100 FAX: 61-2-9417-1077 TOLL FREE (Australia): 1800-177100
TOLL FREE (New Zealand): 0800-900900
URL: www.dlink.com.au E-MAIL: support@dlink.com.au & info@dlink.com.au
- Level 1, 434 St. Kilda Road, Melbourne, Victoria 3004 Australia
TEL: 61-3-9281-3232 FAX: 61-3-9281-3229 MOBILE: 0412-660-064
- Canada** **D-Link Canada**
2180 Winston Park Drive, Oakville, Ontario, L6H 5W1 Canada
TEL: 1-905-829-5033 FAX: 1-905-829-5095 BBS: 1-965-279-8732
TOLL FREE: 1-800-354-6522 URL: www.dlink.ca
FTP: ftp.dlinknet.com E-MAIL: techsup@dlink.ca
- Chile** **D-Link South America**
Isidora Goyechea 2934 of 702, Las Condes, Santiago, Chile, S. A.
TEL: 56-2-232-3185 FAX: 56-2-232-0923 URL: www.dlink.cl
E-MAIL: ccasassu@dlink.cl & tsilva@dlink.cl
- China** **D-Link China**
2F, Sigma Building, 49 Zhichun Road, Haidan District, 100080 Beijing, China
TEL: 86-10-88097777 FAX: 86-10-88096789 URL: www.dlink.com.cn
E-MAIL: liwei@digitalchina.com.cn
- Denmark** **D-Link Denmark**
Naverland 2, DK-2600 Glostrup, Copenhagen, Denmark
TEL: 45-43-969040 FAX: 45-43-424347 URL: www.dlink.dk E-MAIL: info@dlink.dk
- Egypt** **D-Link Middle East**
7 Assem Ebn Sabet Street, Heliopolis, Cairo, Egypt
TEL: 20-2-635-6176 FAX: 20-2-635-6192 URL: www.dlink-me.com
E-MAIL: support@dlink-me.com & fateen@dlink-me.com
- Finland** **D-Link Finland**
Thlli-ja Pakkahuone Katajanokanlaituri 5, FIN- 00160 Helsinki
TEL: 358-9-622-91660 FAX: 358-9-622-91661 URL: www.dlink-fi.com
- France** **D-Link France**
Le Florilege #2, Allee de la Fresnerie, 78330 Fontenay le Fleury, France
TEL: 33-1-3023-8688 FAX: 33-1-3023-8689 URL: www.dlink-france.fr
E-MAIL: info@dlink-france.fr
- Germany** **D-Link Central Europe/D-Link Deutschland GmbH**
Schwalbacher Strasse 74, D-65760 Eschborn, Germany
TEL: 49-6196-77990 FAX: 49-6196-7799300 URL: www.dlink.de
BBS: 49-(0) 6192-971199 (analog) BBS: 49-(0) 6192-971198 (ISDN)
INFO: 00800-7250-0000 (toll free) HELP: 00800-7250-4000 (toll free)
REPAIR: 00800-7250-8000 E-MAIL: info@dlink.de
- India** **D-Link India**
Plot No.5, Kurla-Bandra Complex Rd., Off Cst Rd., Santacruz (E), Bombay, 400 098 India
TEL: 91-22-652-6696 FAX: 91-22-652-8914 URL: www.dlink-india.com
E-MAIL: service@dlink.india.com
- Italy** **D-Link Mediterraneo Srl/D-Link Italia**
Via Nino Bonnet n. 6/b, 20154, Milano, Italy
TEL: 39-02-2900-0676 FAX: 39-02-2900-1723 URL: www.dlink.it E-MAIL: info@dlink.it
- Japan** **D-Link Japan**
10F, 8-8-15 Nishi-Gotanda, Shinagawa-ku, Tokyo 141, Japan
TEL: 81-3-5434-9678 FAX: 81-3-5434-9868 URL: www.d-link.co.jp
E-MAIL: kida@d-link.co.jp
- Netherlands** **D-Link Benelux**
Fellenoord 1305611 ZB, Eindhoven, the Netherlands
TEL: 31-40-2668713 FAX: 31-40-2668666 URL: www.d-link-benelux.nl
- Norway** **D-Link Norway**
Waldemar Thranesgt. 77, 0175 Oslo, Norway
TEL: 47-22-991890 FAX: 47-22-207039

- Russia** **D-Link Russia**
Michurinski Prospekt 49, 117607 Moscow, Russia
TEL: 7-095-737-3389 & 7-095-737-3492 FAX: 7-095-737-3390 URL: www.dlink.ru
E-MAIL: vl@dlink.ru
- Singapore** **D-Link International**
1 International Business Park, #03-12 The Synergy, Singapore 609917
TEL: 65-774-6233 FAX: 65-774-6322 E-MAIL: info@dlink.com.sg
URL: www.dlink-intl.com
- South Africa** **D-Link South Africa**
102 – 106 Witchhazel Avenue, Einstein Park 2, Block B, Highveld Technopark,
Centurion, South Africa
TEL: 27 (0) 12-665-2165 FAX: 27 (0) 12-665-2186 URL: www.d-link.co.za
E-MAIL: attie@d-link.co.za
- Spain** **D-Link Iberia**
C/Sabino De Arana, 56 Bajos, 08028 Barcelona, Spain
TEL: 34 93 4090770 FAX: 34 93 4910795 URL: www.dlinkiberia.es
E-MAIL: info@dlinkiberia.es
- Sweden** **D-Link Sweden**
P. O. Box 15036, S-167 15 Bromma, Sweden
TEL: 46-(0) 8-564-61900 FAX: 46-(0) 8-564-61901 E-MAIL: info@dlink.se
URL: www.dlink.se
- Taiwan** **D-Link Taiwan**
2F, No. 119 Pao-Chung Rd, Hsin-Tien, Taipei, Taiwan
TEL: 886-2-2910-2626 FAX: 886-2-2910-1515 URL: www.dlinktw.com.tw
E-MAIL: dssqa@tsc.dlinktw.com.tw
- Turkey** **D-Link Middle East**
Deniz Bilgisayar, Buyukdere Cad. Naci Kasim Sk., No. 5 Mecidiyekoy, Istanbul, Turkey
TEL: 90-212-213-3400 FAX: 90-212-213-3420 E-MAIL: smorovati@dlink-me.com
- U.A.E.** **D-Link Middle East**
CHS Aptec (Dubai), P.O. Box 33550 Dubai U.A.E.
TEL: 971-4-366-885 FAX: 971-4-355-941 E-MAIL: Wxavier@dlink-me.com
- U.K.** **D-Link Europe**
4th Floor, Merit House, Edgware Road, Colindale, London NW9 5AB United Kingdom
TEL: 44 (0) 20-8731-5555 FAX: 44 (0) 20-8731-5511 BBS: 44 (0) 181-235-5511
URL: www.dlink.co.uk E-MAIL: info@dlink.co.uk
- U.S.A.** **D-Link U.S.A.**
53 Discovery Drive, Irvine, CA 92618, USA
TEL: 1-949-788-0805 FAX: 1-949-753-7033 BBS: 1-949-455-1779 & 1-949-455-9616
INFO: 1-800-326-1688 URL: www.dlink.com
E-MAIL: tech@dlink.com & support@dlink.com

Registration Card

Print, type or use block letters.

Your name: Mr./Ms _____
 Organization: _____ Dept. _____
 Your title at organization: _____
 Telephone: _____ Fax: _____
 Organization's full address: _____

 Country: _____
 Date of purchase (Month/Day/Year): _____

Product Model	Product Serial No.	* Product installed in type of computer (e.g., Compaq 486)	* Product installed in computer serial No.

(* Applies to adapters only)

Product was purchased from:

Reseller's name: _____
 Telephone: _____ Fax: _____
 Reseller's full address: _____

Answers to the following questions help us to support your product:

1. Where and how will the product primarily be used?

Home Office Travel Company Business Home Business Personal Use

2. How many employees work at installation site?

1 employee 2-9 10-49 50-99 100-499 500-999 1000 or more

3. What network protocol(s) does your organization use ?

XNS/IPX TCP/IP DECnet Others _____

4. What network operating system(s) does your organization use ?

D-Link LANsmart Novell NetWare NetWare Lite SCO Unix/Xenix PC NFS 3Com 3+Open
Banyan Vines DECnet Pathwork Windows NT Windows NTAS Windows '95
Others _____

5. What network management program does your organization use ?

D-View HP OpenView/Windows HP OpenView/Unix SunNet Manager Novell NMS
NetView 6000 Others _____

6. What network medium/media does your organization use ?

Fiber-optics Thick coax Ethernet Thin coax Ethernet 10BASE-T UTP/STP
100BASE-TX 100BASE-T4 100VGAnyLAN Others _____

7. What applications are used on your network?

Desktop publishing Spreadsheet Word processing CAD/CAM
Database management Accounting Others _____

8. What category best describes your company?

Aerospace Engineering Education Finance Hospital Legal Insurance/Real Estate Manufacturing
Retail/Chainstore/Wholesale Government Transportation/Utilities/Communication VAR
System house/company Other _____

9. Would you recommend your D-Link product to a friend?

Yes No Don't know yet

10. Your comments on this product?

PLEASE
PLACE STAMP
HERE

TO: _____

D-Link®

Filename: DES-6300 User's Guide final 4.1.doc
Directory: C:\Documents and Settings\Michael Lee\Desktop\DES-6300 User's Guide.final
Template: C:\Documents and Settings\Michael Lee\Application Data\Microsoft\Templates\Normal.dot
Title:
Subject:
Author: CT Snow
Keywords:
Comments:
Creation Date: 2002/9/26 PM 08:42
Change Number: 2
Last Saved On: 2002/9/26 PM 08:42
Last Saved By: Michael Lee
Total Editing Time: 8 Minutes
Last Printed On: 2002/9/26 PM 08:44
As of Last Complete Printing
Number of Pages: 252
Number of Words: 49,472 (approx.)
Number of Characters: 281,991 (approx.)