

## Quick Installation Guide

Nuclias Connect AC1200 Wave 2 Outdoor Access Point

DAP-3666



**D-Link**



## Before You Begin

This installation guide provides instructions for installing the DAP-3666 on your network. Additional documentation is also available on the D-Link support website.

- **Nuclias Connect Manual:** For additional information and instructions on how to configure the device using Nuclias Connect.
- **DAP-3666 User Manual:** For additional information and instructions on how to configure the device using the web user interface.

## Package Contents

This DAP-3666 package includes the following items:

- DAP-3666 Access Point
- Mounting Plate and Hardware
- Grounding Wire
- Quick Start Guide
- Mounting kit (Wall/Pole Mount)
  - Stainless steel mount base x 1
  - Stainless tie back straps x 2
  - Wall screw x 4
  - Wall plug x 4
  - Stainless mount screw (hexagonal hole) x 1

If any of the above items are damaged or missing, please contact your local D-Link reseller.

**Note:** To power the unit, use an 802.3af or 802.3at PoE Switch or PoE Injector.

## System Requirements

- Computers with Windows®, macOS®, or Linux-based operating systems with an installed Ethernet Adapter

- Internet Explorer 11, Safari 7, Firefox 28, or Google Chrome 33 and above (for configuration)

## Hardware Overview

### LED Indicators

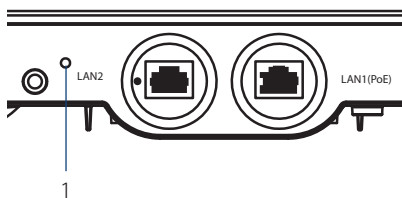

Figure 1: Front Panel LED

#	LED	Description
1	Power/Status	<b>Green (Solid)</b> - Device operational <b>Red (Flashing)</b> - Device booting up/Device malfunctioned <b>Red (Solid)</b> - Device boot up has failed

Table 1: LED Description

### Interface Connectors

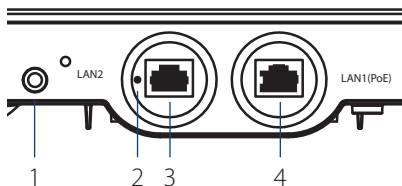

Figure 2: Bottom Connectors

#	Connector	Description
1	Mounting Lock	Connector for the mount screw.
2	Reset	Press and hold for 10 seconds to factory reset the device.
3	LAN2 Port	Gigabit RJ-45 port for data.

#	Connector	Description
4	LAN1(PoE) Port	Gigabit RJ-45 port for data and Power over Ethernet (PoE) power.

Table 2: Interface Description

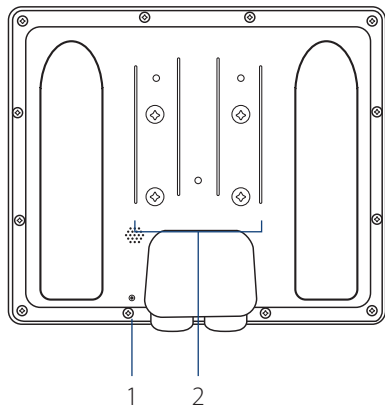

Figure 3: Rear Connectors

#	Connector	Description
1	Grounding Wire	Connector for the grounding wire.
2	Wall/Pole Mount	Mount to connect to the mounting plate on a wall or a pole.

Table 3: Interface Description

## Installation

### Using Power over Ethernet (PoE)

1. Use a standard Ethernet cable to connect the LAN1(PoE) port on the DAP-3666 to a PoE power source device such as an 802.3af or 802.3at PoE switch or PoE injector.

## Configuration

### Using Nuclias Connect

The DAP-3666 is designed to be managed through Nuclias Connect. Refer to the **Nuclias Connect Manual** for detailed configuration instructions.

**Note:** D-Link recommends manually configuring the device before mounting it.

### Nuclias Connect App Configuration

1. Download the free Nuclias Connect app from the App Store or Google Play by searching for **Nuclias Connect** or by scanning the QR code below.



2. Open the Nuclias Connect app and follow the onscreen instructions to discover and set up your device.

### Manual Configuration

**Note:** The management computer, DHCP server and DAP-3666 must be in the same subnet.

Use one of the following methods to access the web user interface:

#### Connecting through Ethernet

1. Use an Ethernet cable to connect the DAP-3666 to the management computer, or to the switch or router the management computer is connected to.

2. Manage the access point from a computer. Enter **dap3666.local** in the address field of your browser.
3. Log in to the administration user interface. The default login information is

Username: **admin**

Password: **admin**

### Connecting Wirelessly

1. Connect the management computer to the default SSID of the DAP-3666, "**dlink**".
2. Manage the access point from a computer. Enter **dap3666.local** in the address field of your browser.
3. Log in to the administration user interface. The default login information is

Username: **admin**

Password: **admin**

## Mounting

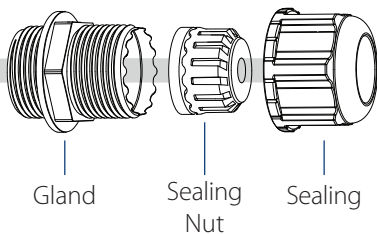

Figure 4: LAN Port Waterproof Enclosure

1. Connect an Ethernet Cable to the LAN1 (PoE) port on the DAP-3666. Use the LAN Port Waterproof Enclosures to seal the ports.

## Mounting on a Pole

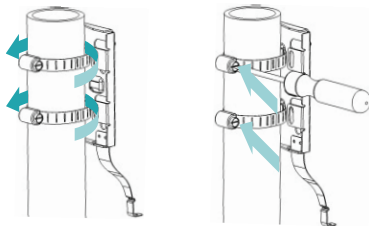

Figure 5: Attaching the Mounting Plate

1. Secure mount base to the pole with the two stainless tie back strap sets. Ensure that the tie back is locked securely.

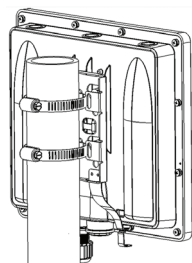
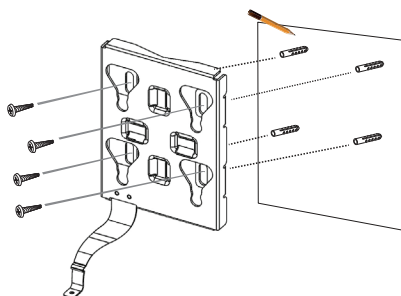

Figure 6: Mounting the Device

2. Align and slide the DAP-3666 down so that the mounting plate securely locks to the DAP-3666.

## Mounting on a Solid Wall



**Figure 7: Attaching the Mounting Plate**

1. Use the mounting plate to mark the location where to drill the holes in the wall.
2. Drill holes on the markings and place the included anchors into the drilled holes.
3. Align and place the mounting plate on top of the anchors and use the included screws to secure the mounting plate to the surface.

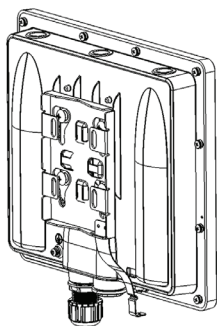
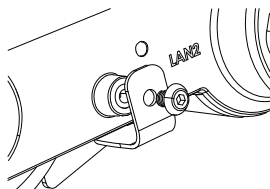

**Figure 8: Mounting the Device**

4. Align and slide the DAP-3666 down so that the mounting plate securely locks to the DAP-3666.

## Securing the Mount Screw and

## Connecting the Grounding Wire



**Figure 9: Attaching the Mount Screw**

1. Use the included mount screw (hexagonal hole) to lock the DAP-3666 to the pole/wall mount.

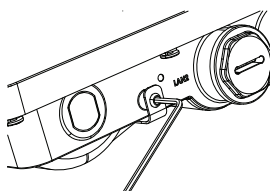

**Figure 10: Securing the Mount Screw**

2. With the included hexagon socket spanner, tighten the mount screw until the DAP-3666 is secured.

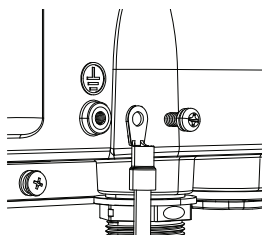

**Figure 11: Attaching the Grounding Wire**

3. A grounding wire is to protect your device from lightning strikes and the buildup of static electricity. Attach the grounding wire to the DAP-3666 using the included screw(M3.9 \* 7.8 mm).

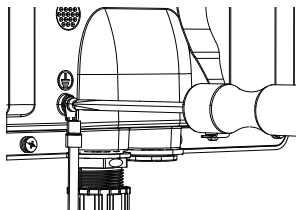

**Figure 12: Attaching the Grounding Wire**

4. Tighten the grounding wire (green-and-yellow, 18AWG) to the DAP-3666 until it is securely attached.

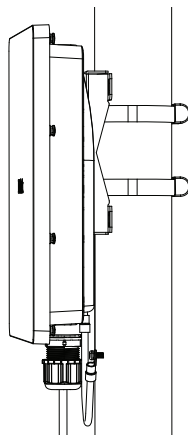

**Figure 13: Attaching the Grounding Wire**

5. Attach the other end of the grounding wire to either the wall or pole mount. Ensure that the wall or pole mount is connected to an electrical ground.

# Appendix - Statements

## ErP Power Usage

This device is an Energy Related Product (ErP) that automatically switches to a power-saving Network Standby mode within 1 minute of no packets being transmitted. It can also be turned off through a power switch to save energy when it is not needed.

Network Standby: 5.84 watts

## Federal Communication Commission Interference Statement

This device complies with Part 15 of the FCC Rules. Operation is subject to the following two conditions: (1) This device may not cause harmful interference, and (2) this device must accept any interference received, including interference that may cause undesired operation.

This equipment has been tested and found to comply with the limits for a Class A digital device, pursuant to Part 15 of the FCC Rules. These limits are designed to provide reasonable protection against harmful interference in a residential installation. This equipment generates, uses and can radiate radio frequency energy and, if not installed and used in accordance with the instructions, may cause harmful interference to radio communications. However, there is no guarantee that interference will not occur in a particular installation. If this equipment does cause harmful interference to radio or television reception, which can be determined by turning the equipment off and on, the user is encouraged to try to correct the interference by one of the following measures:

- Reorient or relocate the receiving antenna.
- Increase the separation between the equipment and receiver.
- Connect the equipment into an outlet on a circuit different from that to which the receiver is connected.
- Consult the dealer or an experienced radio/TV technician for help.

## FCC Caution:

- Any changes or modifications not expressly approved by the party responsible for compliance could void the user's authority to operate this equipment.
- This transmitter must not be co-located or operating in conjunction with any other antenna or transmitter.



### Radiation Exposure Statement:

This equipment complies with FCC radiation exposure limits set forth for an uncontrolled environment. This equipment should be installed and operated with minimum distance 20cm between the radiator & your body.

**Note:** The country code selection is for non-US model only and is not available to all US model. Per FCC regulation, all WiFi product marketed in US must fixed to US operation channels only.

### Déclaration d'exposition aux radiations

Cet équipement est conforme aux limites d'exposition aux rayonnements ISED établies pour un environnement non contrôlé. Cet équipement doit être installé et utilisé avec un minimum de 0.28 m de distance entre la source de rayonnement et votre corps.

### VCCI-A Warning

この装置は、クラスA機器です。この装置を住宅環境で使用すると電波妨害を引き起こすことがあります。この場合には使用者が適切な対策を講ずるよう要求されることがあります。 VCCI-A

### 警告使用者:

此為甲類的資訊技術設備，在居住環境中使用時，可能會造成射頻擾動，在這種情況下，使用者會被要求採取某些適當的對策。

## Product and Warranty Information

To find out more about D-Link Nuclias product or marketing information, please visit the website <http://www.dlink.com> or <https://www.nuclias.com>.

The D-Link Limited Lifetime Warranty information is available at <http://www.dlink.com/warranty>

1. Instructions for the installation of that conductor to building earth by a SKILLED PERSON.
2. Please contact the authorized distributor of D-Link for related accessories (Outdoor interconnection cable, Cable Gland, Cable, etc.) for purchase and installation.

## Industry Canada statement

This device complies with ISED's licence-exempt RSSs. Operation is subject to the following two conditions: (1) This device may not cause harmful interference, and (2) this device must accept any interference received, including interference that may cause undesired operation.

Le présent appareil est conforme aux CNR d'ISED applicables aux appareils radio exempts de licence. L'exploitation est autorisée aux deux conditions suivantes : (1) le dispositif ne doit pas produire de brouillage préjudiciable, et (2) ce dispositif doit accepter tout brouillage reçu, y compris un brouillage susceptible de provoquer un fonctionnement indésirable.

- This Class A digital apparatus complies with Canadian ICES-003.
- Cet appareil numérique de la classe A est conforme à la norme NMB-003 du Canada.
- This device and its antenna(s) must not be co-located or operating in conjunction with any other antenna or transmitter, except tested built-in radios.
- Cet appareil et son antenne ne doivent pas être situés ou fonctionner en conjonction avec une autre antenne ou un autre émetteur, exception faites des radios intégrées qui ont été testées.
- The County Code Selection feature is disabled for products marketed in the US/ Canada.
- La fonction de sélection de l'indicatif du pays est désactivée pour les produits commercialisés aux États-Unis et au Canada.

### Caution :

(iv) where applicable, antenna type(s), antenna models(s), and worst-case tilt angle(s) necessary to remain compliant with the e.i.r.p. elevation mask requirement set forth in section 6.2.2.3 shall be clearly indicated.

### Avertissement:

(iv) lorsqu'il y a lieu, les types d'antennes (s'il y en a plusieurs), les numéros de modèle de l'antenne et les pires angles d'inclinaison nécessaires pour rester conforme à l'exigence de la p.i.r.e. applicable au masque d'élévation, énoncée à la section 6.2.2.3, doivent être clairement indiqués

### Radiation Exposure Statement:

This equipment complies with ISED radiation exposure limits set forth for an uncontrolled environment. This equipment should be installed and operated with greater than 21 cm between the radiator & your body.

### Déclaration d'exposition aux radiations:

Cet équipement est conforme aux limites d'exposition aux rayonnements ISED établies pour un environnement non contrôlé. Cet équipement doit être installé et utilisé à plus de 21 cm entre le radiateur et votre corps.

## Déclaration d'Industrie Canada

Cet appareil est conforme aux RSS exempts de licence de l'ISDE. L'opération est soumise aux deux conditions suivantes : 1) Ce dispositif ne risque pas de produire des interférences nuisibles, et 2) il doit accepter tous types d'interférences reçues, y compris celles qui peuvent entraîner un dysfonctionnement.

- Cet appareil numérique de la classe A est conforme à la norme ICES-003 / NMB-003 du Canada.
- Cet appareil et son ou ses antennes ne doivent pas être installés au même endroit ou fonctionner en conjonction avec une autre antenne ou un autre émetteur, à l'exception des radios intégrées testées.
- La fonction de sélection du code du comté est désactivée pour les produits commercialisés aux États-Unis et au Canada.

### Attention :

(iv) le cas échéant, le ou les types d'antenne, modèles d'antenne et angles d'inclinaison les plus défavorables nécessaires pour rester conforme à l'exigence de masque d'élévation de la p.i.e. énoncée au point 6.2.2.3 doivent être clairement indiqués.

### Déclaration d'exposition aux rayonnements :

Cet équipement est conforme aux limites d'expositions aux rayonnements ISDE énoncées pour un environnement non contrôlé. Cet équipement doit être installé et utilisé à une distance supérieure à 21 cm entre l'élément rayonnant et votre corps.

### CE Warning

RED Compliance Statement

Compliance with 2014/53/EU Radio Equipment Directive (RED)

In accordance with Article 10.8(a) and 10.8(b) of the RED, the following table provides information on the frequency bands used and the maximum RF transmit power of the product for sale in the EU:

Frequency range (MHz)	Max. transmit power (dBm)
2412-2472	19.91 dBm
5180-5240 (for indoor only)	22.53 dBm
5260-5320 (for indoor only)	22.55 dBm
5500-5700	29.48 dBm

This equipment should be installed and operated with a minimum distance of 20 centimeters between the radiator and your body.

## Notes

## Notes

## Notes



**D-Link**<sup>®</sup>  
Building Networks for People



Ver. 2.02(WW)\_130x183  
2023/02/13  
5300-00008439-01W