



# Quick Start Guide

DAP-2230



**D-Link**

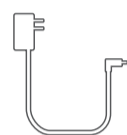
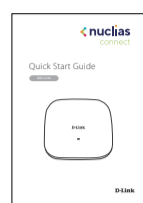
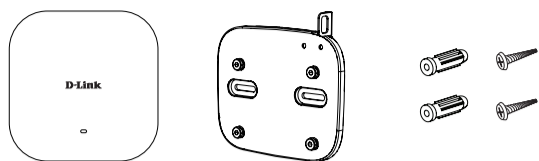

Optional



1

Nuclias Connect



2

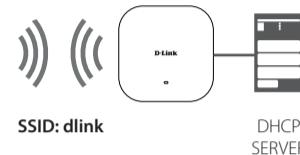

1

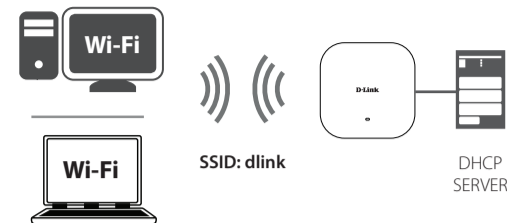

OR

2

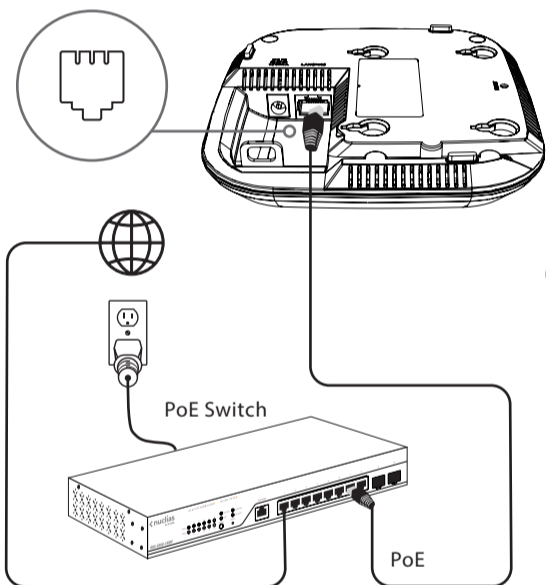
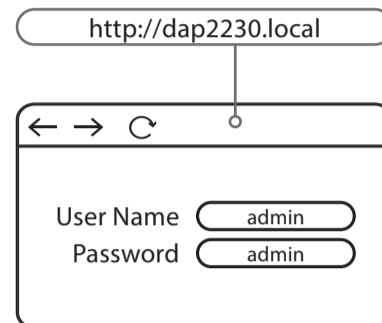

OR

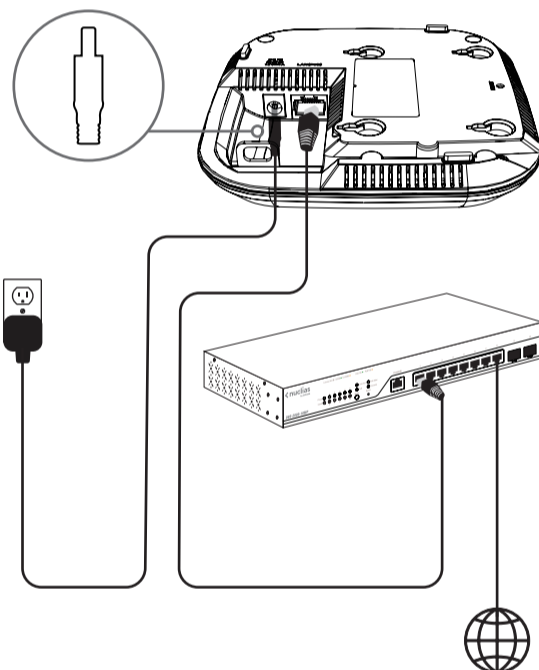

1

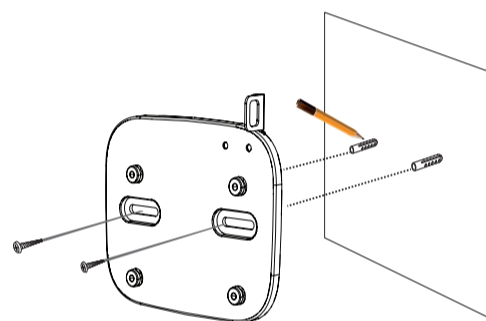

2

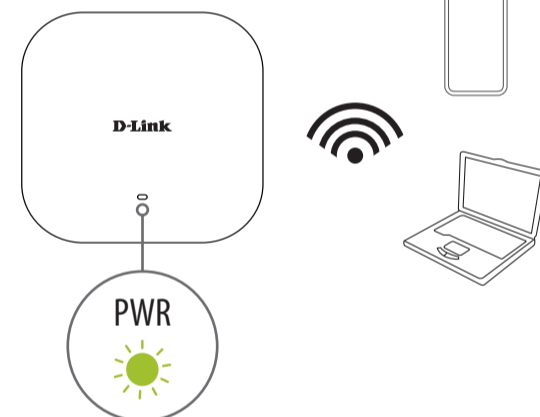
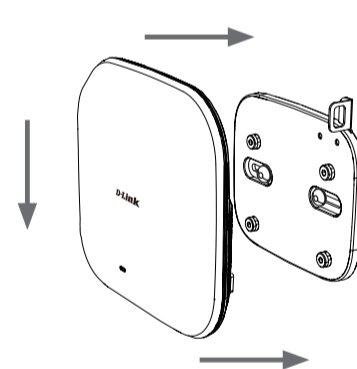

<https://www.nuclias.com>



<https://www.dlink.com/support>



<https://download.nuclias.com>



<https://www.dlink.com/warranty>