

# Unterstützte Mesh Netzwerkaufbauten Supported Mesh Network Environments

Für / For:  
COVR-1102/1103, COVR-X1862/1863  
R/M/E15, R/M32, M30/M60/E30

Zum Teil für / Partly for: COVR-C1202/C1203, COVR-2202/2203

**Ja/Yes:**

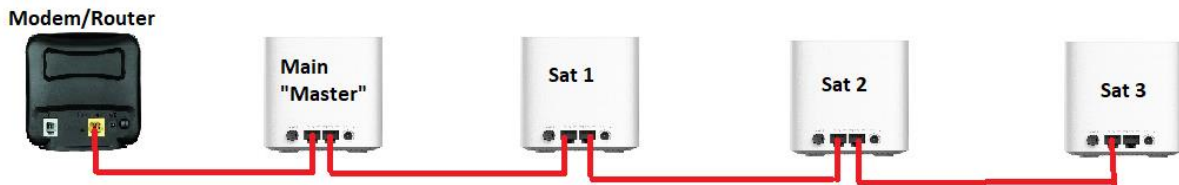

**Ja/Yes:**



**Ja/Yes:**

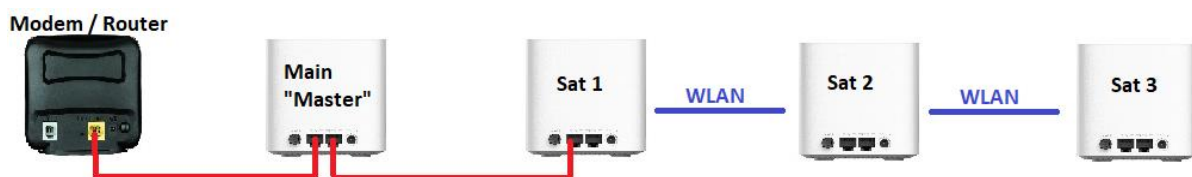

## Ja/Yes:

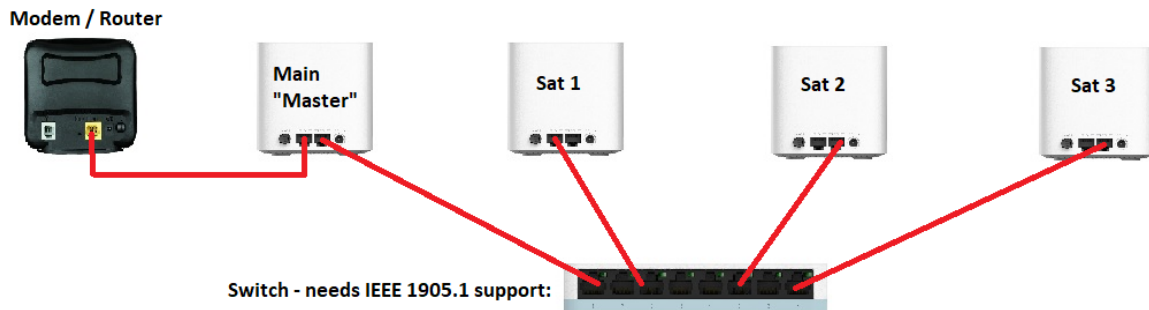

**Wichtig:** Der Switch muss den Netzwerkstandard IEEE 1905.1 unterstützen\*  
**Important:** The switch must support the network standard IEEE 1905.1\*

## Ja/Yes:

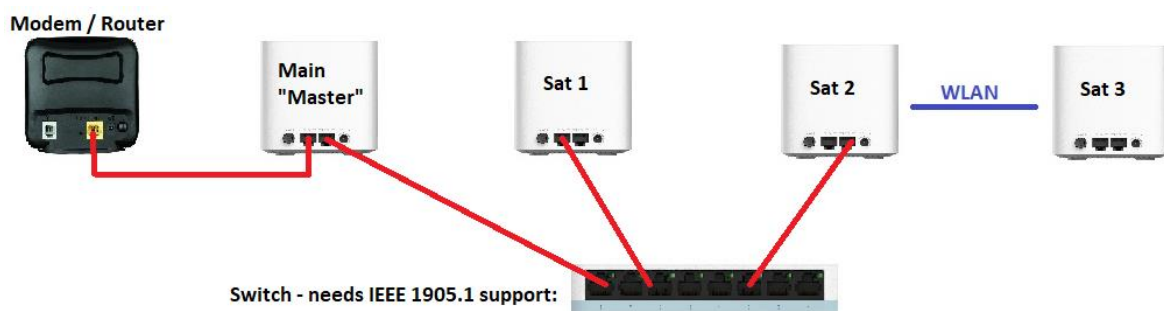

**Wichtig:** Der Switch muss den Netzwerkstandard IEEE 1905.1 unterstützen\*  
**Important:** The switch must support the network standard IEEE 1905.1\*

## Ja/Yes:

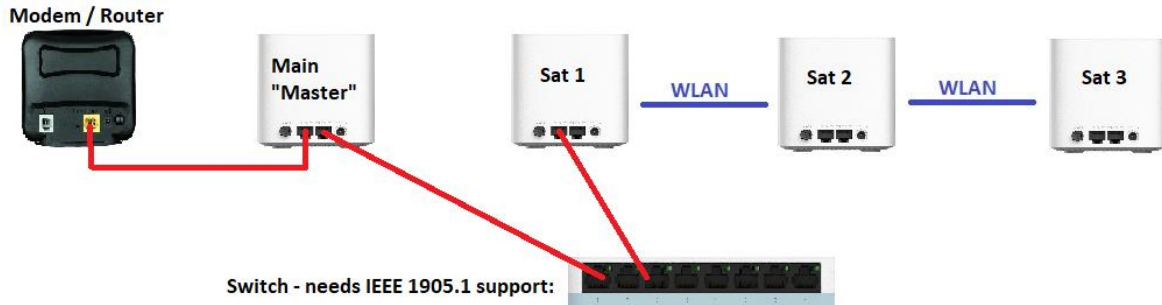

**Wichtig:** Der Switch muss den Netzwerkstandard IEEE 1905.1 unterstützen\*  
**Important:** The switch must support the network standard IEEE 1905.1\*

## Ja/Yes:

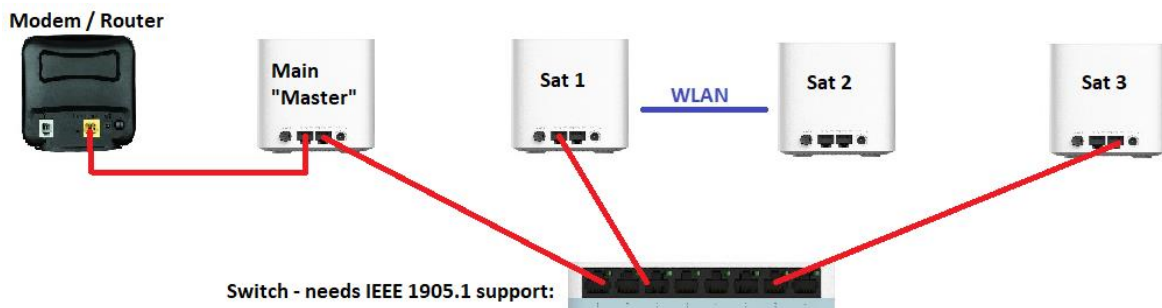

**Wichtig:** Der Switch muss den Netzwerkstandard IEEE 1905.1 unterstützen\*  
**Important:** The switch must support the network standard IEEE 1905.1\*

## Ja/Yes:

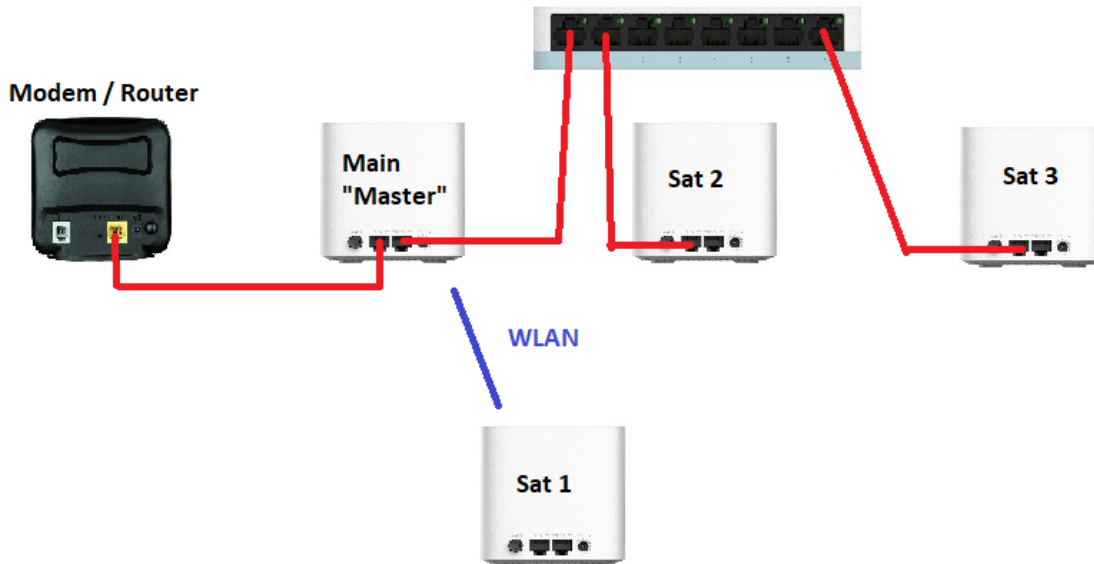

**Wichtig:** Der Switch muss den Netzwerkstandard IEEE 1905.1 unterstützen\*  
**Important:** The switch must support the network standard IEEE 1905.1\*

## Ja/Yes:

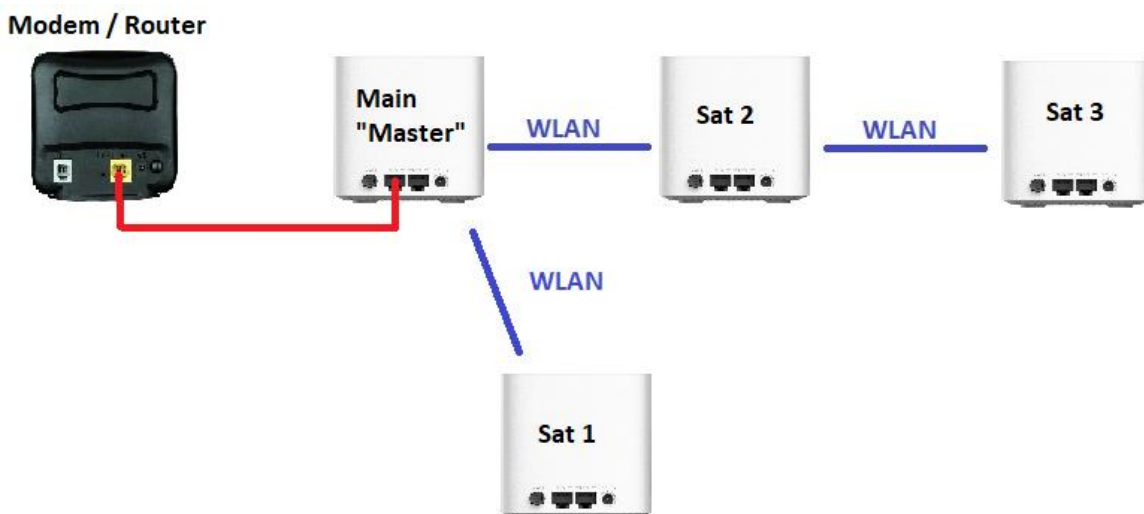

## Ja/Yes:

Modem / Router

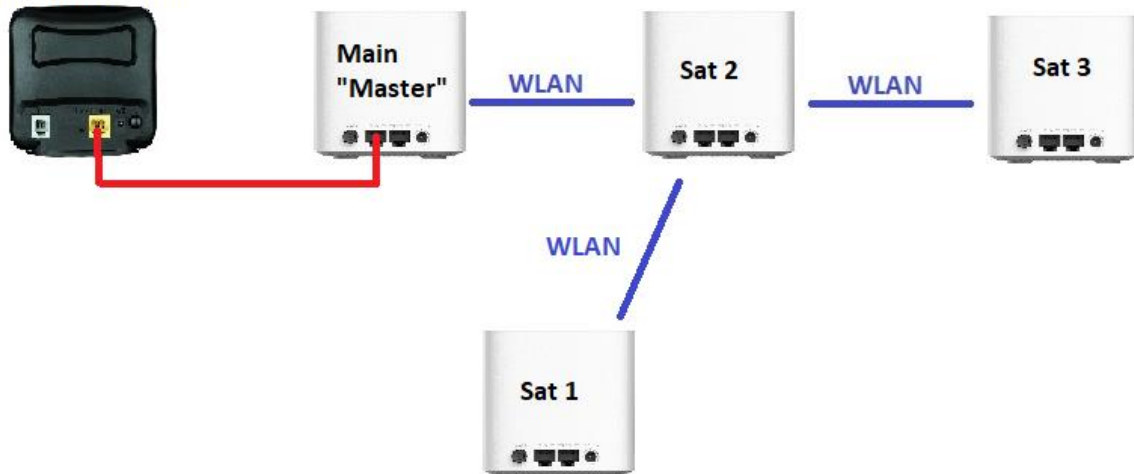

## Ja/Yes:

Modem / Router

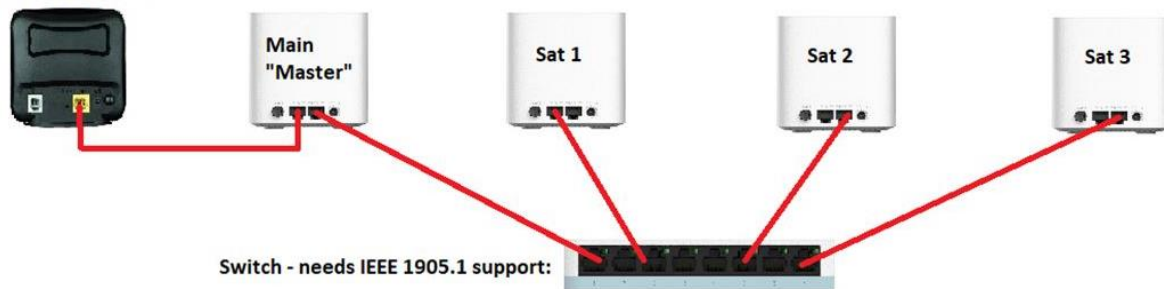

**Wichtig:** Der Switch muss den Netzwerkstandard IEEE 1905.1 unterstützen\*

**Important:** The switch must support the network standard IEEE 1905.1\*

**Ja/Yes:**

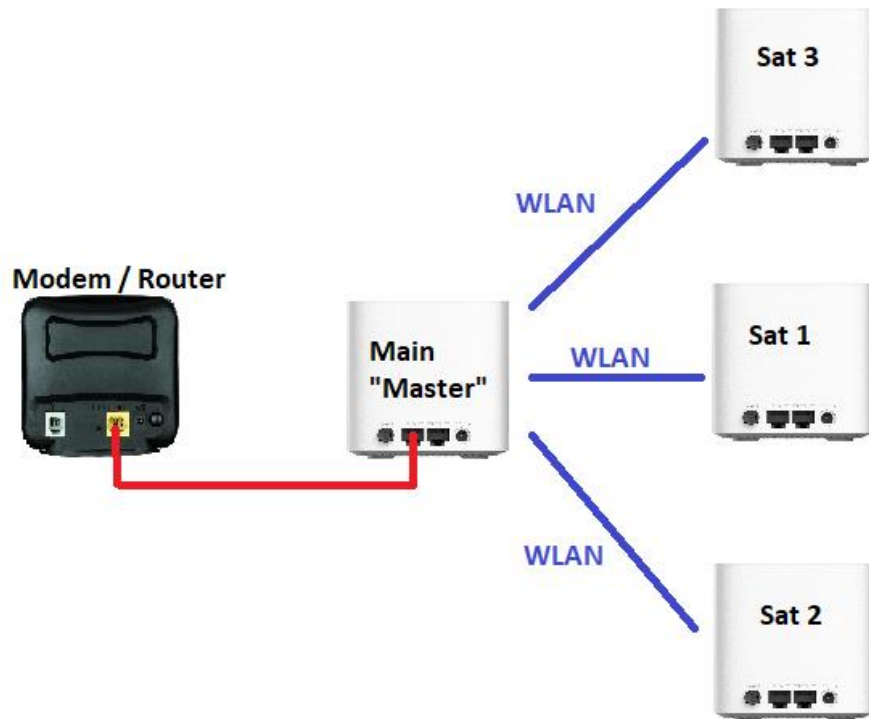

## Folgendes nur gültig für die neueren Mesh-Modelle Following valid just for the newer Mesh-models

### Ja/Yes:

**Wichtig:** Nicht unterstützt von den älteren COVR-Modellen:

**Important:** Not supported by the older COVR-models:

- COVR-C1202/C1203
- COVR-2202/2203

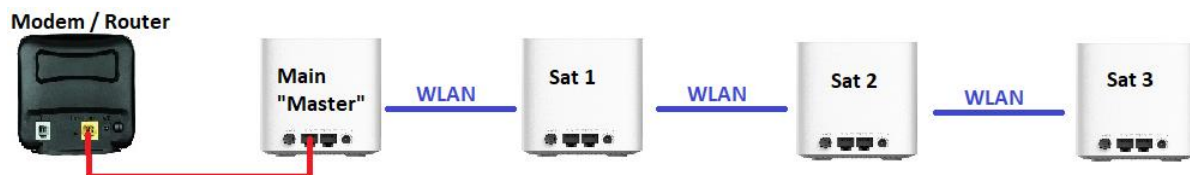

### Ja/Yes:

**Wichtig:** Nicht unterstützt von den älteren COVR-Modellen:

**Important:** Not supported by the older COVR-models:

- COVR-C1202/1203
- COVR-2202/2203

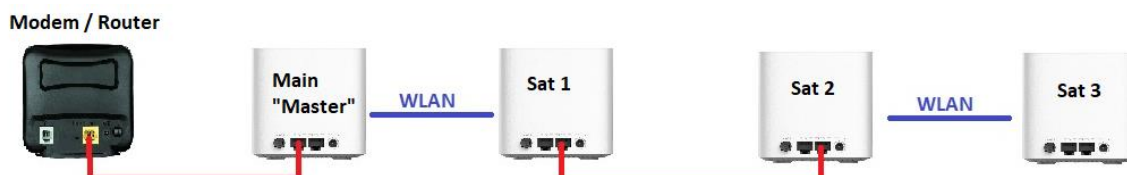

## Ja/Yes:

**Wichtig:** Nicht unterstützt von den älteren COVR-Modellen:

**Important:** Not supported by the older COVR-models:

- COVR-C1202/1203
- COVR-2202/2203

Modem / Router



## Ja/Yes:

**Wichtig:** Nicht unterstützt von den älteren COVR-Modellen:

**Important:** Not supported by the older COVR-models:

- COVR-C1202/1203
- COVR-2202/2203

Modem / Router





\* Unseren geeigneten Heimnetzwerk-Switches mit **IEEE1905.1** Unterstützung sind:

\* Our compatible home network switches with **IEEE 1905.1** support are:

- Die aufgelisteten Switches und Powerline Adapter ab der angegebenen Hardware Revisionen (Rev.).

- The listed switches and powerline adapters from the specified Hardware Revisions (Rev.).

### **Unmanged Switches:**

DES/DGS-105/108 Rev.C6 + F1

DGS-105GL/108GL Rev.A1

DGS-1005D Rev.J1

DGS-1008D Rev.K1

DGS-1016D Rev.H1

DGS-1024D Rev. G1 + H1

DGS-1016S Rev.A1

GO-SW-5G/GO-SW-8G Rev.E1

GO-SW-16G Rev.C1

### **Managed Switches:**

DES/DGS-1100-Serie Rev.B1

DES/DGS-1210-Serie Rev.F1 + G1

DGS-1510-Serie Rev.A1

Die folgenden **Powerline Adapter** sind geeignet:

The following **Powerline Adapters** are compatible:

DHP-601AV Rev.C1

DHP-P601AV Rev.B1

DHP-701AV Rev.C1